

OPERATOR'S MANUAL

MODELS 9420/50
DUAL-CHANNEL
DIGITAL OSCILLOSCOPES

Serial Number 2128
December 1989

LeCroy

Corporate Headquarters

700 Chestnut Ridge Road
Chestnut Ridge, NY 10977-6499
Tel: (914) 425-2000, TWX: 710-577-2832

European Headquarters

2, chemin Pré-de-la-Fontaine
P.O. Box 341
1217 Meyrin 1/Geneva, Switzerland
Tel.: (022) 719 21 11, Telex: 419 058

Copyright® December 1989, LeCroy. All rights reserved. Information in this publication supersedes all earlier versions. Specifications subject to change.

TABLE OF CONTENTS

1 General Information

Initial Inspection	1
Warranty	1
Product Assistance	1
Maintenance Agreements	1
Documentation Discrepancies	2
Service Procedure	2
Return Procedure	2

2 9420 Product Description

Introduction	3
9420 Architecture	3
ADCs and Memories	4
Trigger	4
Automatic Calibration	5
Display	5
Manual/Remote Control	6
Specifications	6

3 9450 Product Description

Introduction	13
9450 Architecture	13
ADCs and Memories	14
Trigger	14
Automatic Calibration	15
Display	15
Manual/Remote Control	16
Specifications	16

4 Installation

Safety Information	23
Operating Voltage	23
Power On	23

5 Display Layout

Real Time Clock Field (I)	26
Menu Field (II)	26

Table of Contents

Icon Field (III)	26
Trigger Delay Field (IV)	26
Time and Frequency Field (V)	26
Abridged Trigger Configuration Field (VI)	26
Abridged Front-panel Status Field (VII)	27
Displayed Trace Field (VIII)	27
Message Field (IX)	28
Trigger Level Indicator Fields (X)	28
6 Manual Operation	
Vertical Controls	29
9420 Time-base Controls	32
9450 Time-base Controls	35
Probes	37
Bandwidth Limit	37
Trigger controls (Standard)	37
Displaying Traces	44
Display Control and Expansion	45
Standard Waveform Processing	49
Screen Adjustments	51
Cursors	51
Pulse Parameters	56
Remote Control and Interruption	63
Automatic Setup	63
Menu Field (II) Controls	63
Panel Status Menu	64
Memory Status Menu	66
Saving and Recall of Front-Panel Setups	72
Auxiliary Setups (6)	75
X Versus Y Display	82
Store Menu	85
Special Modes	86
7 The SMART Trigger	
Introduction	89
Applications	89
Manipulating the SMART Trigger	97
Single-Source Trigger Modes	100
Multi-Source Trigger Modes	111

8 The Rear Panel

Mains Voltage Selection (60)	127
Fuse Protection	127
Power Switch (59)	127
Accessory Power Connectors (66)	127
GPIB and RS-232-C Port Selection (63)	128
RS-232-C Connector (61)	128
Accessory Control (62)	129
BNC Connectors	129
External CK Input	129
Sampling CK Output	129
Trigger Out	129
Trigger Veto	129
Reset (64)	130

9 Getting Started

Waveform Acquisition	131
Saving and Recalling Front-Panel Setups	144
Storing and Recalling Waveforms	145
Waveform Expansion	146
Waveform Processing	153

10 Getting More From Your 9420/50

Rapid Response of the Front-panel Controls	157
Accurate Amplitude Measurements	157
Accurate Time Measurements	158
Auto-Calibration	161

11 Waveform Processing Option (WP01)

Processing Capabilities	163
Summed Average	164
Continuous average	166
Arithmetic	168
Extrema	169
Functions	171
Enhanced Resolution	172

Table of Contents

12 FFT Option (WP02)

Fourier Transform	185
FFT Power Average	188
Processing Facilities	189
Cursors	189
FFT Interruption (Abort)	189
FFT Algorithms	190
Examples of FFT Processing	193
FFT Glossary	196
Error Messages	200
References	201

GENERAL INFORMATION

INITIAL INSPECTION

It is recommended that the shipment be thoroughly inspected immediately upon delivery to the purchaser. All material in the container should be checked against the enclosed Packing List. LeCroy cannot accept responsibility for shortages in comparison with the Packing List unless notified promptly. If the shipment is damaged in any way, please contact the Customer Service Department or local field office immediately.

WARRANTY

LeCroy warrants its oscilloscope products to operate within specifications under normal use for a period of two years from the date of shipment. Spares, replacement parts and repairs are warranted for 90 days. The instrument's firmware is thoroughly tested and thought to be functional, but is supplied "as is" with no warranty of any kind covering detailed performance. Products not manufactured by LeCroy are covered solely by the warranty of the original equipment manufacturer.

In exercising this warranty, LeCroy will repair or, at its option, replace any product returned to the Customer Service Department or an authorized service facility within the warranty period, provided that the warrantor's examination discloses that the product is defective due to workmanship or materials and that the defect has not been caused by misuse, neglect, accident or abnormal conditions or operation.

The purchaser is responsible for the transportation and insurance charges arising from the return of products to the servicing facility. LeCroy will return all in-warranty products with transportation prepaid.

This warranty is in lieu of all other warranties, expressed or implied, including but not limited to any implied warranty of merchantability, fitness, or adequacy for any particular purpose or use. LeCroy shall not be liable for any special, incidental, or consequential damages, whether in contract or otherwise.

PRODUCT ASSISTANCE

Answers to questions concerning installation, calibration, and use of LeCroy equipment are available from the Customer Service Department, 700 Chestnut Ridge Road, Chestnut Ridge, New York 10977-6499, U.S.A., tel. (914)578-6059, and 2, chemin Pré-de-la-Fontaine, 1217 Meyrin 1, Geneva, Switzerland, tel. (41)22/719 21 11, or your local field engineering office.

MAINTENANCE AGREEMENTS

LeCroy offers a selection of customer support services. For example, maintenance agreements provide extended warranty and allow the customer to budget maintenance costs after the initial two year warranty has expired. Other services requested by the customer such as installation, training, on-site repair, and addi-

1 *General Information*

tion of engineering improvements are made available through specific Supplemental Support Agreements.

DOCUMENTATION DISCREPANCIES

LeCroy is committed to providing state-of-the-art instrumentation and is continually refining and improving the performance of its products. While physical modifications can be implemented quite rapidly, the corrected documentation frequently requires more time to produce. Consequently, this manual may not agree in every detail with the accompanying product. There may be small discrepancies in the values of components for the purposes of pulse shape, timing, offset, etc., and, occasionally, minor logic changes. Where any such inconsistencies exist, please be assured that the unit is correct and incorporates the most up-to-date circuitry.

SERVICE PROCEDURE

Products requiring maintenance should be returned to the Customer Service Department or authorized service facility. LeCroy will repair or replace any product under warranty at no charge. The purchaser is only responsible for the transportation charges arising from return of the goods to the service facility.

For all LeCroy products in need of repair after the warranty period, the customer must provide a Purchase Order Number before any equipment which does not operate correctly can be repaired or replaced. The customer will be billed for the parts and labor for the repair, as well as for shipping.

RETURN PROCEDURE

To determine your nearest authorized service facility, contact the Customer Service Department or your field office. All products returned for repair should be identified by the model and serial numbers and include a description of the defect or failure, name and phone number of the user, and, in the case of products returned to the factory, a Return Authorization Number (RAN). The RAN may be obtained by contacting the Customer Service Department in New York, tel. (914)578-6097, in Geneva, tel. (41)22/719 21 11, or your nearest sales office.

Return shipments should be made prepaid. LeCroy will not accept C.O.D. or Collect Return Shipments. Air-freight is generally recommended. Wherever possible, the original shipping carton should be used. If a substitute carton is used, it should be rigid and be packed such that the product is surrounded with a minimum of four inches of excelsior or similar shock-absorbing material. In addressing the shipment, it is important that the Return Authorization Number be displayed on the outside of the container to ensure its prompt routing to the proper department within LeCroy.

INTRODUCTION

The LeCroy 9420 is a wide bandwidth digital oscilloscope suited to a variety of engineering design and test applications. It is used to capture, analyze, display and archive electrical waveforms in fields such as analog and digital engineering, automated test and measurement, telecommunication and electronics research.

9420 ARCHITECTURE

The 9420 features two 100 megasample/second 8-bit Flash ADC systems, two 50K non-volatile memories for waveform acquisition and storage, and an additional four 50K memories for waveform processing and temporary storage. High-speed internal data transfer and processing are performed using a multi-processor system. The central processor is a powerful Motorola 68020 microprocessor which performs computations and controls the oscilloscope's operation.

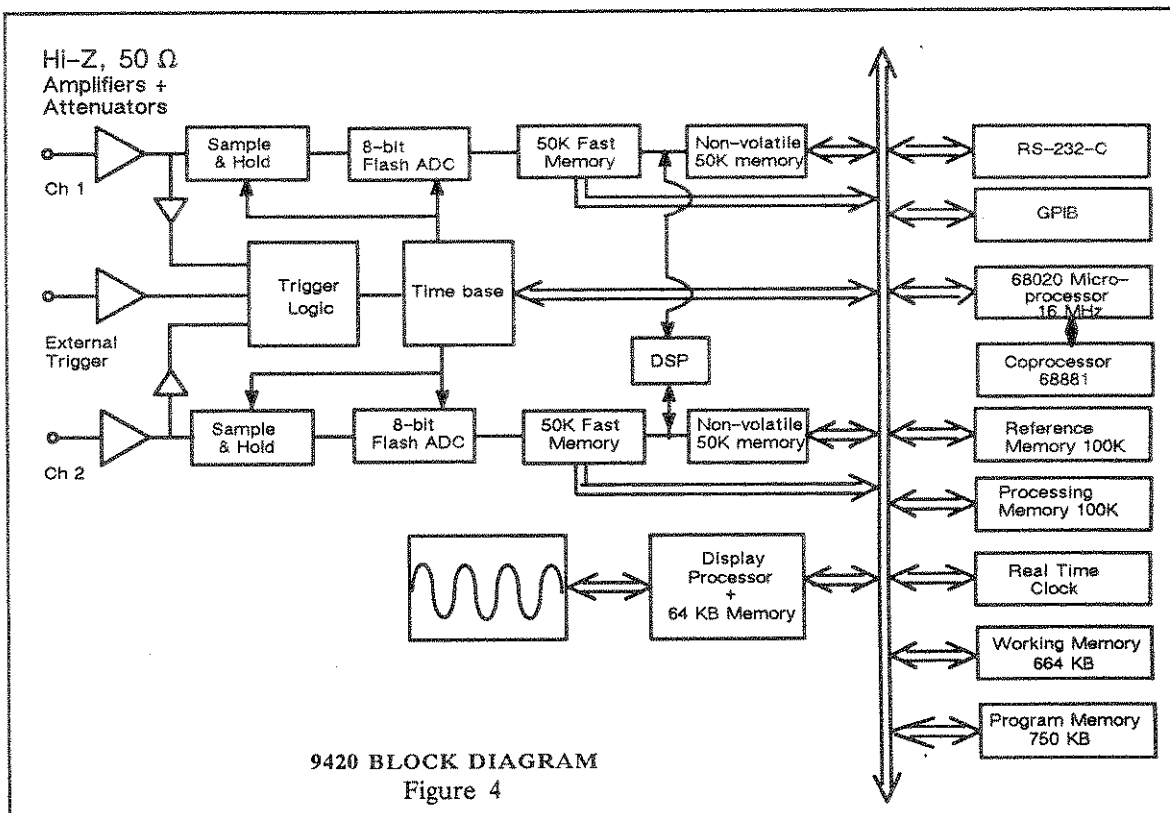

All front-panel knobs and buttons are constantly monitored by the internal processor, and front-panel setups are rapidly reconfigured via the unit's internal 16-bit bus. Data are quickly

processed according to the selected front-panel setups, and are transferred to the display memory for direct waveform display or stored in the 9420's reference memories.

The 68020 controls the unit's GPIB (IEEE-488) remote control port, as well as the RS-232-C port which is used to directly interface the 9420 to a digital plotter, printer, remote terminal or other slow-speed device.

ADCs AND MEMORIES

Each of the 9420's two identical input channels is equipped with a 100 megasample/second, 8-bit ADC and a 50 kiloword acquisition memory (see Figure 4). This dual ADC architecture ensures absolute amplitude and phase correlation, maximum ADC performance for both single- and dual-channel acquisition modes, large record lengths and excellent time resolution.

The 9420's two 50K acquisition memories simplify transient capture by providing very long waveform records that capture waveforms even when trigger timing or signal speed is uncertain. In addition, a special expansion facility magnifies waveforms by up to 1000 times the selected time-base speed.

The 9420 oscilloscope is capable of acquiring and storing repetitive signals at a Random Interleaved Sampling (RIS) rate of 10 gigasamples/second. RIS is a high-precision, digitizing technique that enables measurement of repetitive signals to a bandwidth of 350 MHz with an effective sampling interval of 100 psec and measurement resolution of 5 psec.

The 9420 assures precision measurements over its entire range of operation.

TRIGGER

The 9420's digitally-controlled trigger system offers an extensive range of trigger capabilities. Front-panel and menu controls let the user choose the appropriate trigger function for the signal.

In the standard trigger mode the 9420's front-panel controls are used to select and set parameters such as pre- and post-trigger recording, sequence and roll modes, in addition to the Auto, Normal and Single (Hold) modes. The trigger source can be line, external or either of the two inputs. The coupling is selected from HF, AC, LF REJECT, HF REJECT and DC and the slope from positive and negative.

The SMART trigger facility provides a complete range of sophisticated and versatile trigger features. The following trigger classes and operational modes are available:

Trigger Classes	Operational Modes
Single-source trigger Pattern trigger	Hold-off by time Hold-off by number of events Pulse width > Pulse width < (FASTGLITCH) Interval width > Interval width <
State-qualified trigger Time/event qualified trigger	Wait for a given time Wait for a given event count
TV trigger	Trigger on a given line in a chosen field

AUTOMATIC CALIBRATION

The 9420 has an automatic calibration facility that ensures overall vertical accuracy of $\pm 2\%$ of full scale and a time-base interpolator accuracy of ± 20 psec RMS for the unit's crystal-controlled time base.

The time base is calibrated each time the 9420's time-base control is adjusted to a new Time/div setting; vertical gain and offset calibration take place each time the front-panel fixed gain control for either Chan 1 or Chan 2 is adjusted to a new Volts/div setting. Both channels are also calibrated each time the Bandwidth Limit button is pressed. In addition, the 9420 performs periodic calibration to ensure the long term stability at a particular setting.

DISPLAY

The 9420's large 12.5×17.5 cm (5×7 inches) screen displays waveforms with high resolution and serves as an interactive, user-friendly interface via a set of pushbuttons located immediately to the left and right of the CRT.

The oscilloscope displays up to four waveforms, while simultaneously reporting the parameters controlling signal acquisition. In addition, the screen presents internal status and measurement results, as well as operational, measurement, and waveform analysis menus.

A hard copy of the 9420's screen is available via the unit's front-panel screen dump button. Plotting is done in parallel with normal oscilloscope operation.

MANUAL/REMOTE CONTROL

The 9420's front-panel layout and operation will be very familiar to users of analog oscilloscopes. The "analog" feel is emphasized by rapid instrument response and the fact that waveforms are presented instantly on the high-resolution screen.

The 9420 has also been designed for remote control operation in automated testing and computer-aided measurement applications. The entire measurement process, including cursor and pulse parameter settings, dynamic modification of front-panel settings and display organization, can be controlled via the rear-panel GPIB (IEEE-488) and RS-232-C ports.

The LeCroy 9420 is capable of storing up to seven front-panel setups which may be recalled either manually or by remote control, thus ensuring rapid oscilloscope front-panel configuration. When the power is switched off, the current 9420 front-panel setting is automatically stored, for subsequent recall, at the next power on.

SPECIFICATIONS

Vertical Analog Section

Bandwidth (- 3 dB):

@ 50 Ω : DC to 350 MHz.

@ 1 M Ω AC: < 10 Hz to 250 MHz typical at the probe tip.

@ 1 M Ω DC: DC to 250 MHz typical at the probe tip.

Input impedance: 1 M Ω // 30 pF and 50 Ω \pm 1%.

Channels: Two independent channels; standard BNC connector inputs.

Sensitivity: 5 mV/div to 2.5 V/div continuously variable from 1 to 2.5 times the fixed setting. Fixed settings range from 5 mV/div to 1 V/div in a 1, 2, 5 sequence.

Vertical expansion: up to 5 times (with averaging, up to 10 times or 500 μ V/div sensitivity).

Scale factors: Probe attenuation factors of $\times 1$, $\times 10$, $\times 100$, $\times 1000$ or $\times 10000$ may be selected and are remotely programmable.

Offset: \pm 12 times the fixed sensitivity setting in 0.02 division increments up to ± 10 V max.; ± 24 div @ 10 mV/div; ± 48 div @ 5 mV/div.

DC accuracy: $\leq \pm 2\%$.

Bandwidth limiter: 80 MHz (- 3 dB) typical.

Max input voltage: 250 V (DC + peak AC) at 1 M Ω , ± 5 V DC (500 mW) or 5 V RMS at 50 Ω .

Vertical Digital Section	<p>ADCs: One per channel, 8-bit Flash.</p> <p>Conversion rate: Up to 100 megasamples/sec for transients, up to 10 gigasamples/sec for repetitive signals, simultaneously on both channels.</p> <p>Aperture uncertainty: ± 10 psec.</p> <p>Acquisition memories, Channel 1 and 2: Non-volatile memories (battery backed for a minimum of 2 years) of 50 kilowords per channel can be segmented into 2, 5, 10, 20, 50, 100 or 200 blocks.</p> <p>Reference memories, C and D: 50K, 16-bit word memories which can store one acquired and/or processed waveform, or up to 200 waveforms when segmented.</p> <p>Function memories E and F: Two 50K, 16-bit word memories for waveform processing.</p>
Peak and Glitch Detection	<p>Minimum and maximum peaks, as fast as 0.002% of the record length (minimum 10 nsec), are captured and displayed with 100% probability.</p> <p>Using LeCroy's new FASTGLITCH trigger technique (see the trigger section below), glitches faster than 2.5 nsec can be detected on all time-base settings.</p>
Horizontal Section	
Time Base	<p>Range: 1 nsec/div to 5000 sec/div.</p> <p>Clock accuracy: $\leq \pm 0.01\%$.</p> <p>Interpolator resolution: 5 psec.</p> <p>Sampling clock output: BNC connector on rear panel.</p> <p>External clock in: BNC connector on rear panel.</p>
Acquisition Modes	<p>Random Interleaved Sampling (RIS) for repetitive signals from 1 nsec/div to 20 μsec/div;</p> <p>Single shot for transient signals and repetitive signals from 50 nsec/div to 200 msec/div;</p> <p>Roll for slowly changing signals from 500 msec/div to 5000 sec/div.</p> <p>Sequence mode divides the acquisition memory into 2, 5, 10, 20, 50, 100, or 200 segments.</p>
Horizontal expansion	<p>Dual zoom mode allows two different signals or two different sections of the same signal to be expanded up to 1000 times.</p>

Trigger

Pretrigger recording: Adjustable in 0.2% increments to 100% of full scale (grid width).

Post-trigger delay: Adjustable in 0.02 division increments up to 10,000 divisions.

External trigger input: 1 M Ω , < 20 pF, 250 V max. (DC + peak AC).

External trigger range: ± 2 V in Ext, ± 20 V in Ext/10.

Rate: Up to 500 MHz using HF trigger coupling.

Timing: Trigger timing (date and time) is listed in the memory status menu. The timing of subsequent triggers in sequence mode is measured with 0.1 sec absolute resolution, or nanosecond resolution relative to the time of the first trigger.

Trigger out: BNC connector on rear panel.

Trigger veto: BNC connector on rear panel.

Standard Trigger

Sources: Chan1, Chan2, Line, Ext, Ext/10. Chan1, Chan2 and Ext have independent trigger circuits allowing slope, coupling and level to be set individually for each source.

Slope: Positive, negative.

Coupling: HF, AC, LF REJ, HF REJ, DC.

Modes:

Auto: Automatically re-arms after each sweep. If no trigger occurs, one is generated at an appropriate rate.

Normal: Re-arms after each sweep. If no trigger occurs after a reasonable length of time, the warning message "No or Slow Trigger" is displayed.

Single (hold): Holds display after a trigger occurs. Re-arms only when the "single" button is pressed again.

Sequence: Stores multiple events in segmented acquisition memories.

SMART Trigger

Single-source trigger operational modes:

Hold-off by time: 25 nsec to 20 sec.

Hold-off by events: 0 to 1,000,000,000 events.

Width-based trigger modes:

Pulse width < (FASTGLITCH): Triggers on opposite slopes of pulses narrower than a value in the range 2.5 nsec to 20 sec.

Pulse width >: Triggers on opposite slopes of pulses wider than a value in the range 2.5 nsec to 20 sec.

Interval width <: Triggers on similar slopes of signals narrower than a value in the range 10 nsec to 20 sec.

Interval width >: Triggers on similar slopes of signals wider than a value in the range 25 nsec to 20 sec.

Multi-source trigger operational modes:

Pattern: Triggers on the logical AND of the three sources Chan1, Chan2 and Ext, where each source can be defined as high (H), low (L) or don't care (X). The trigger can be selected at the beginning (entered) or at the end (exited) of the specified pattern. All the single-source operational modes are also available.

Bi-level: This is a special condition of pattern trigger which allows the 9420 to trigger on any signal that exceeds a certain preset high or low trigger level. The signal must be connected simultaneously to two channels. The third trigger channel must be set to don't care (X).

State qualified: Allows the 9420 to trigger on any source (Chan1, Chan2 or Ext), while requiring that a certain pattern of the other two channels is present or absent. An additional wait by time or by number of events can be selected from the moment the pattern is valid to the moment at which the trigger is valid.

Time/Event qualified: Allows the 9420 to trigger on any source (Chan1, Chan2 or Ext), as soon as a certain pattern of the three channels is entered or exited. From the moment of validity, a delay until a source trigger is accepted can be defined in terms of time or number of events.

TV trigger operational modes:

Any line: Triggers at the beginning of the front porch of a composite video signal applied to the Ext trigger input.

Line mode: Triggers at the beginning of the front porch of the chosen line of a composite video signal applied to the Ext trigger input.

Field choice: The 9420 allows the user to select which field the chosen line should be in. The field can be specified in

the range 1 to the total number of fields. This total number of fields can take one of the values 1, 2, 4 or 8. The 9420's hardware circuits can distinguish between the odd and even fields for the standard forms of TV signals. Knowledge of the time interval between triggers allows the 9420 to make a "relative" distinction between fields 1, 3, 5, and 7 (or 2, 4, 6, and 8). This is the exclusive "FIELDLOCK" feature of the 9420. It should be noted that this final field identification is not absolute. The 9420 offers direct support for the two most common system characteristics 625/50/2:1 and 525/60/2:1. It also supports an extended class with arbitrary line count, 50 or 60 fields/sec and arbitrary interlace factor.

Display

CRT: 12.5 × 17.5 cm (5 × 7 inches); magnetic deflection; vector type.

Resolution: 4096 × 4096 points.

Real-time clock: Date, hours, minutes, seconds.

Grid: Internally generated; separate intensity control for grid and waveforms. Single, dual and pulse parameter measurement grid modes.

XY mode: Plots any two sources (Chan1 and 2, Expand A and B, Memories C and D, and functions E and F) against one another. Operates on live waveforms with cursor readout.

Hard copy: Single- or multi-pen digital plotters as well as printers can be used to make hard copies of the display. Screen dumps are activated by a front-panel button or via remote control. Plotters supported are: the HP 7400 and 7500 series, Philips PM 8151, Graphtek FP 5301, and compatible models. Plotting can be done in parallel with normal 9420 operation. Printers supported are: IBM, EPSON (and compatibles) and the HP ThinkJet, QuietJet and LaserJet.

Graphics: All waveforms and display information are presented using vector (linear) graphics. Expanded waveforms use LeCroy's DOT-LINEAR graphics that highlight actual data points and interpolate linearly between them.

Menus: Waveform storage; acquisition parameters; memory status; save/recall front-panel configurations; SMART trigger; waveform parameters, RS-232-C configuration; hardcopy setup and real-time clock setup, averaging, and arithmetic.

Cursors

Relative time: Two cursors provide time measurements with a vertical resolution of ± 0.2% of full scale for unexpanded traces; up to ± 0.001% or ≈ 10% of data point sampling interval. The corresponding frequency information is also provided.

Relative voltage: Two horizontal bars measure voltage differences to $\pm 0.2\%$ of full scale for each trace.

Absolute time: A cross-hair marker measures the time relative to the trigger, as well as absolute voltage versus signal ground.

Absolute voltage: A reference bar measures absolute voltage with respect to ground.

Pulse parameters: Two cross-hair cursors are used to define a region of interest for which pulse parameters will be calculated automatically.

Auto-setup

Pressing the auto-setup button automatically scales the time-base, trigger and sensitivity settings to provide a stable display for a wide range of repetitive input signals.

Type of signals detected: Repetitive signals with amplitudes between 2 mV and 8 V, frequency above 50 Hz and a duty cycle greater than 0.1%.

Auto-setup time: Approximately 2 sec.

Waveform Processing

Waveform processing routines are called and set up via menus. These include arithmetic functions (add, subtract and invert), and summation averaging (up to 1000 signals).

Pulse parameters: Based on ANSI/IEEE Std 181-1977 "Standard on Pulse Measurement and Analysis by Objective Techniques". The terminology is derived from IEEE Std 194-1977 "Standard Pulse Terms and Definitions".

Automatic measurements determine:

Maximum	Period
Minimum	Pulse width
Mean	Risetime
Standard deviation	Falltime
RMS	Delay

Sources: Chan1, Chan2, Memory C or D, Function E or F, Expand A or B. Cursors define the measurement zone. With more than 1 pulse present in the measurement zone, averaged results for period, width, risetime and falltime are presented.

Remote Control

Front-panel controls, including variable gain, offset, position controls and cursors, as well as all internal functions are programmable.

RS-232-C port: For computer/terminal control or plotter connection. Asynchronous up to 19200 baud.

2 9420 Product Description

GPIB port: (IEEE-488). Configured as talker/listener for computer control and fast data transfer. Address switches on rear panel.

Local/remote: Remote control can be interrupted for local (manual) control at any time (except when in remote control with the lock-out state selected) by pushing a button on the front panel.

Probes

Model: Two P9020 ($\times 10$, 10 M Ω // 3.33 pF) probes supplied.

Probe calibration: 1 kHz square wave, 1 V p-p.

Probe power: Two rear-panel power outlets for use with active probes provide ± 15 V, + 5 V DC.

Self Tests

Auto-calibration ensures accuracy of:

Overall DC accuracy: $\pm 2\%$ full scale at settings > 5 mV/div
 $\pm 3\%$ full scale at 5 mV/div

Time: 20 psec RMS.

General

Temperature: 5 to 40° C (41 to 104° F) rated; 0 to 50° C (32 to 122° F) operating.

Humidity: $< 80\%$.

Power required: 110 or 220 V AC, 45 to 440 Hz, 275 W.

Battery backup: Lithium batteries maintain front-panel settings and waveform data for 2 years.

Enclosure: (HWD) 19.2 \times 36.5 \times 46.5 cm, (7½ \times 14½ \times 19½ inch).

Weight: 15 kg (33 lbs) net, 20 kg (44 lb) shipping.

Warranty: 2 years.

INTRODUCTION

The LeCroy 9450 is a high-performance digital oscilloscope suited to a wide variety of research, design and test applications. It is used to capture, analyze, display and archive electrical waveforms in fields such as electronic engineering, physics and defense research, automated testing and measurement, telecommunications, laser research, computer design, electromagnetic pulse and interference measurement, lidar technology and ultrasonics research.

9450 ARCHITECTURE

The 9450 features two 400 megasample/second 8-bit Flash ADC systems, two 50K non-volatile memories for waveform acquisition and storage, and an additional four 50K memories for waveform processing and temporary storage. High-speed internal data transfer and processing are performed using a multi-processor system. The central processor is a powerful Motorola 68020 microprocessor which performs computations and controls the oscilloscope's operation.

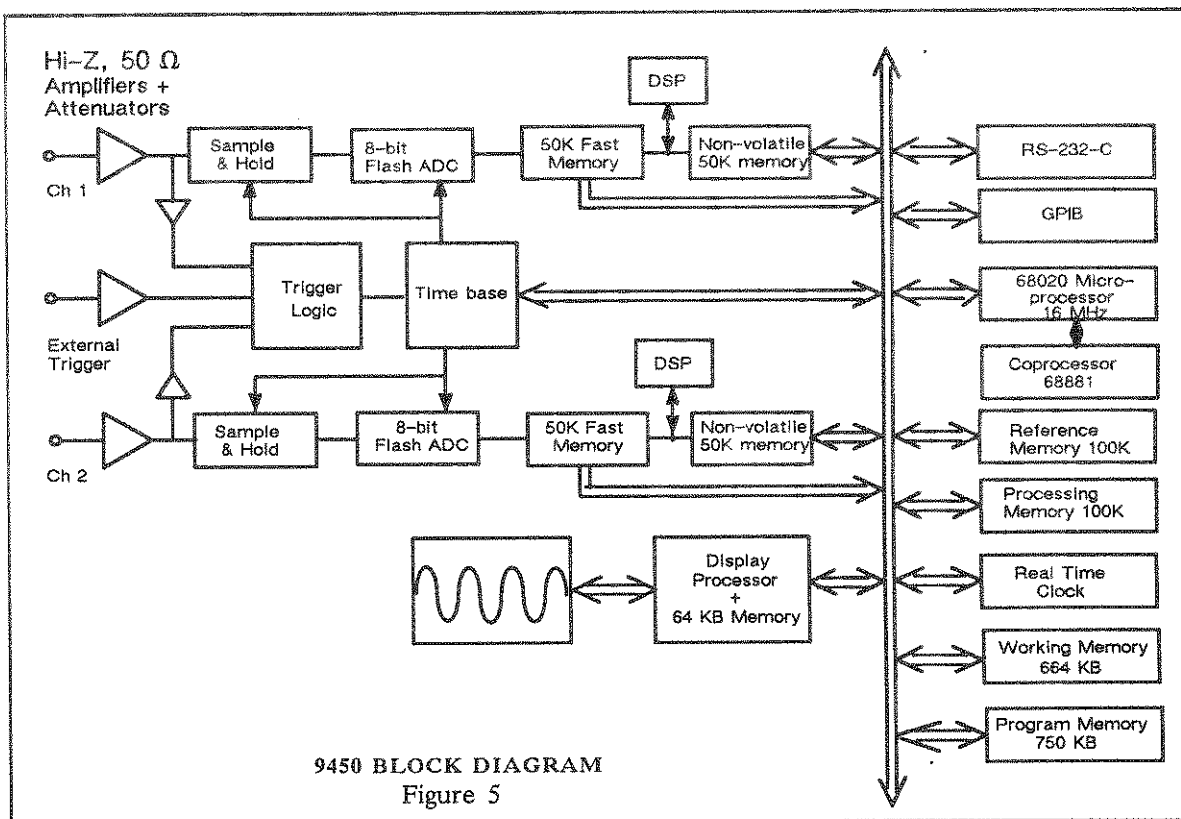

All front-panel knobs and buttons are constantly monitored by the internal processor, and front-panel setups are rapidly reconfigured via the unit's internal 16-bit bus. Data are quickly processed according to the selected front-panel setups, and are transferred to the display memory for direct waveform display or stored in the 9450's reference memories.

The 68020 controls the unit's GPIB (IEEE-488) remote control port, as well as the RS-232-C port which is used to directly interface the 9450 to a digital plotter, printer, remote terminal or other slow-speed device.

ADCs AND MEMORIES

Each of the 9450's two identical input channels is equipped with a 400 megasample/second, 8-bit ADC and a 50 kiloword acquisition memory (see Figure 5). This dual ADC architecture ensures absolute amplitude and phase correlation, maximum ADC performance for both single- and dual-channel acquisition modes, large record lengths and excellent time resolution.

The 9450's two 50K acquisition memories simplify transient capture by providing very long waveform records that capture waveform features even when trigger timing or signal speed is uncertain. In addition, a special expansion facility magnifies waveforms by up to 1000 times the selected time-base speed.

The 9450 oscilloscope is capable of acquiring and storing repetitive signals at a Random Interleaved Sampling (RIS) rate of 10 gigasamples/second. RIS is a high-precision, digitizing technique that enables measurement of repetitive signals to a bandwidth of 350 MHz with an effective sampling interval of 100 psec and measurement resolution of 5 psec.

The 9450 assures precision measurements over its entire range of operation.

TRIGGER

The 9450's digitally-controlled trigger system offers an extensive range of trigger capabilities. Front-panel and menu controls let the user choose the appropriate trigger function for the signal.

In the standard trigger mode the 9450's front-panel controls are used to select and set parameters such as pre- and post-trigger recording, sequence and roll modes, in addition to the Auto, Normal and Single (Hold) modes. The trigger source can be line, external or either of the two inputs. The coupling is selected from HF, AC, LF REJECT, HF REJECT and DC and the slope from positive and negative.

The SMART trigger facility provides a complete range of sophisticated and versatile trigger features. The following trigger classes and operational modes are available:

Trigger Classes	Operational Modes
Single-source trigger Pattern trigger	Hold-off by time Hold-off by number of events Pulse width > Pulse width < (FASTGLITCH) Interval width > Interval width <
State-qualified trigger Time/event qualified trigger	Wait for a given time Wait for a given event count
TV trigger	Trigger on a given line in a chosen field

AUTOMATIC CALIBRATION

The 9450 has an automatic calibration facility that ensures overall vertical accuracy of $\pm 2\%$ of full scale and a time-base interpolator accuracy of ± 20 psec RMS for the unit's crystal-controlled time base.

The time base is calibrated each time the 9450's time-base control is adjusted to a new Time/div setting; vertical gain and offset calibration take place each time the front-panel fixed gain control for either Chan 1 or Chan 2 is adjusted to a new Volts/div setting. Both channels are also calibrated each time the Bandwidth Limit button is pressed. In addition, the 9450 performs periodic calibration to ensure the long term stability at a particular setting.

DISPLAY

The 9450's large 12.5×17.5 cm (5×7 inches) screen displays waveforms with high resolution and serves as an interactive, user-friendly interface via a set of pushbuttons located immediately to the left and right of the CRT.

The oscilloscope displays up to four waveforms, while simultaneously reporting the parameters controlling signal acquisition. In addition, the screen presents internal status and measurement results, as well as operational, measurement, and waveform analysis menus.

A hard copy of the 9450's screen is available via the unit's front-panel screen dump button. Plotting is done in parallel with normal 9450 operation.

MANUAL/REMOTE CONTROL

The 9450's front-panel layout and operation will be very familiar to users of analog oscilloscopes. The "analog" feel is emphasized by rapid instrument response and the fact that waveforms are presented instantly on the high-resolution screen.

The 9450 has also been designed for remote control operation in automated testing and computer-aided measurement applications. The entire measurement process, including cursor and pulse parameter settings, dynamic modification of front-panel settings and display organization, can be controlled via the rear-panel GPIB (IEEE-488) and RS-232-C ports.

The LeCroy 9450 is capable of storing up to seven front-panel setups which may be recalled either manually or by remote control, thus ensuring rapid oscilloscope front-panel configuration. When the power is switched off, the current 9450 front-panel setting is automatically stored, for subsequent recall, at the next power on.

SPECIFICATIONS

Vertical Analog Section

Bandwidth (- 3 dB):

@ 50 Ω : DC to 350 MHz.

@ 1 M Ω AC: < 10 Hz to 250 MHz typical at the probe tip.

@ 1 M Ω DC: DC to 250 MHz typical at the probe tip.

Input impedance: 1 M Ω // 30 pF and 50 Ω \pm 1%.

Channels: Two independent channels; standard BNC connector inputs.

Sensitivity: 5 mV/div to 2.5 V/div continuously variable from 1 to 2.5 times the fixed setting. Fixed settings range from 5 mV/div to 1 V/div in a 1, 2, 5 sequence.

Vertical expansion: up to 5 times (with averaging, up to 10 times or 500 μ V/div sensitivity).

Scale factors: Probe attenuation factors of $\times 1$, $\times 10$, $\times 100$, $\times 1000$ or $\times 10000$ may be selected and are remotely programmable.

Offset: \pm 12 times the fixed sensitivity setting in 0.02 division increments up to \pm 10 V max.; \pm 24 div @ 10 mV/div; \pm 48 div @ 5 mV/div.

DC accuracy: \leq \pm 2%.

Bandwidth limiter: 80 MHz (- 3 dB) typical.

Max input voltage: 250 V (DC + peak AC) at 1 M Ω , \pm 5 V DC (500 mW) or 5 V RMS at 50 Ω .

Vertical Digital Section	<p>ADCs: One per channel, 8-bit Flash.</p> <p>Conversion rate: Up to 400 megasamples/sec for transients, up to 10 gigasamples/sec for repetitive signals, simultaneously on both channels.</p> <p>Aperture uncertainty: ± 10 psec.</p> <p>Acquisition memories, Channel 1 and 2: Non-volatile memories (battery backed for a minimum of 2 years) of 50 kilowords per channel can be segmented into 2, 5, 10, 20, 50, 100 or 200 blocks.</p> <p>Reference memories, C and D: 50K, 16-bit word memories which can store one acquired and/or processed waveform, or up to 200 waveforms when segmented.</p> <p>Function memories E and F: Two 50K, 16-bit word memories for waveform processing.</p>
Peak and Glitch Detection	<p>Minimum and maximum peaks, as fast as 0.002% of the record length (minimum 2.5 nsec), are captured and displayed with 100% probability.</p> <p>Using LeCroy's new FASTGLITCH trigger technique (see the trigger section below), glitches faster than 2.5 nsec can be detected on all time-base settings.</p>
Horizontal Section	
Time Base	<p>Range: 1 nsec/div to 5000 sec/div.</p> <p>Clock accuracy: $\leq \pm 0.01\%$.</p> <p>Interpolator resolution: 5 psec.</p> <p>Sampling clock output: BNC connector on rear panel.</p> <p>External clock in: BNC connector on rear panel.</p>
Acquisition Modes	<p>Random Interleaved Sampling (RIS) for repetitive signals from 1 nsec/div to 5 μsec/div;</p> <p>Single shot for transient signals and repetitive signals from 10 nsec/div to 200 msec/div;</p> <p>Roll for slowly changing signals from 500 msec/div to 5000 sec/div.</p> <p>Sequence mode divides the acquisition memory into 2, 5, 10, 20, 50, 100, or 200 segments.</p>
Horizontal expansion	<p>Dual zoom mode allows two different signals or two different sections of the same signal to be expanded up to 1000 times.</p>

Trigger

Pretrigger recording: Adjustable in 0.2% increments to 100% of full scale (grid width).

Post-trigger delay: Adjustable in 0.02 division increments up to 10,000 divisions.

External trigger input: 1 M Ω , < 20 pF, 250 V max. (DC + peak AC).

External trigger range: ± 2 V in Ext, ± 20 V in Ext/10.

Rate: Up to 500 MHz using HF trigger coupling.

Timing: Trigger timing (date and time) is logged in the memory status menu. The timing of subsequent triggers in sequence mode is measured with 0.1 sec absolute resolution, or nanosecond resolution relative to the time of the first trigger.

Trigger out: BNC connector on rear panel.

Trigger veto: BNC connector on rear panel.

Standard Trigger

Sources: Chan1, Chan2, Line, Ext, Ext/10. Chan1, Chan2 and Ext have independent trigger circuits allowing slope, coupling and level to be set individually for each source.

Slope: Positive, negative.

Coupling: HF, AC, LF REJ, HF REJ, DC.

Modes:

Auto: Automatically re-arms after each sweep. If no trigger occurs, one is generated at an appropriate rate.

Normal: Re-arms after each sweep. If no trigger occurs after a reasonable length of time, the warning message "No or Slow Trigger" is displayed.

Single (hold): Holds display after a trigger occurs. Re-arms only when the "single" button is pressed again.

Sequence: Stores multiple events in segmented acquisition memories.

SMART Trigger

Single-source trigger operational modes:

Hold-off by time: 25 nsec to 20 sec.

Hold-off by events: 0 to 1,000,000,000 events.

Width-based trigger modes:

Pulse width < (FASTGLITCH): Triggers on opposite slopes of pulses narrower than a value in the range 2.5 nsec to 20 sec.

Pulse width >: Triggers on opposite slopes of pulses wider than a value in the range 2.5 nsec to 20 sec.

Interval width <: Triggers on similar slopes of signals narrower than a value in the range 10 nsec to 20 sec.

Interval width >: Triggers on similar slopes of signals wider than a value in the range 25 nsec to 20 sec.

Multi-source trigger operational modes:

Pattern: Triggers on the logical AND of the three sources Chan1, Chan2 and Ext, where each source can be defined as high (H), low (L) or don't care (X). The trigger can be selected at the beginning (entered) or at the end (exited) of the specified pattern. All the single-source operational modes are also available.

Bi-level: This is a special condition of pattern trigger which allows the 9450 to trigger on any signal that exceeds a certain preset high or low trigger level. The signal must be connected simultaneously to two channels. The third trigger channel must be set to don't care (X).

State qualified: Allows the 9450 to trigger on any source (Chan1, Chan2 or Ext), while requiring that a certain pattern of the other two channels is present or absent. An additional wait by time or by number of events can be selected from the moment the pattern is valid to the moment at which the trigger is accepted.

Time/Event qualified: Allows the 9450 to trigger on any source (Chan1, Chan2 or Ext), as soon as a certain pattern of the three channels is entered or exited. From the moment of validity, a wait until a source trigger is accepted can be defined in terms of time or number of events.

TV trigger operational modes:

Any line: Triggers at the beginning of the front porch of a composite video signal applied to the Ext trigger input.

Line mode: Triggers at the beginning of the front porch of the chosen line of a composite video signal applied to the Ext trigger input.

Field choice - The 9450 allows the user to select which field the chosen line should be in. The field can be specified

the range 1 to the total number of fields. This total number of fields can take one of the values 1, 2, 4 or 8. The 9450's hardware circuits can distinguish between the odd and even fields for the standard forms of TV signals. Knowledge of the time interval between triggers allows the 9450 to make a "relative" distinction between fields 1, 3, 5, and 7 (or 2, 4, 6, and 8). This is the exclusive "FIELDLOCK" feature of the 9450. It should be noted that this final field identification is not absolute. The 9450 offers direct support for the two most common system characteristics 625/50/2:1 and 525/60/2:1. It also supports an extended class with arbitrary line count, 50 or 60 fields/sec and arbitrary interlace factor.

Display

CRT: 12.5 × 17.5 cm (5 × 7 inches); magnetic deflection; vector type.

Resolution: 4096 × 4096 points.

Real-time clock: Date, hours, minutes, seconds.

Grid: Internally generated; separate intensity control for grid and waveforms. Single, dual, and pulse parameter measurement grid modes.

XY mode: Plots any two sources (Chan1 and 2, Expand A and B, Memories C and D, and functions E and F) against one another. Operates on live waveforms with cursor readout.

Hard copy: Single- or multi-pen digital plotters as well as printers can be used to make hard copies of the display. Screen dumps are activated by a front-panel button or via remote control. Plotters supported are: the HP 7400 and 7500 series, Philips PM 8151, Graphtek FP 5301, and compatible models. Plotting can be done in parallel with normal 9450 operation. Printers supported are: IBM, EPSON (and compatibles) and the HP ThinkJet, QuietJet and LaserJet.

Graphics: All waveforms and display information are presented using vector (linear) graphics. Expanded waveforms use LeCroy's DOT-LINEAR graphics that highlight actual data points and interpolate linearly between them.

Menus: Waveform storage; acquisition parameters; memory status; save/recall front-panel configurations; SMART trigger; waveform parameters, RS-232-C configuration; hardcopy setup and real-time clock setup, averaging, and arithmetic.

Cursors

Relative time: Two cursors provide time measurements with a vertical resolution of $\pm 0.2\%$ of full scale for unexpanded traces; up to $\pm 0.001\%$ or $\approx 10\%$ of data point sampling interval. The corresponding frequency information is also provided.

Relative voltage: Two horizontal bars measure voltage differences to $\pm 0.2\%$ of full scale for each trace.

Absolute time: A cross-hair marker measures the time relative to the trigger, as well as absolute voltage versus signal ground.

Absolute voltage: A reference bar measures absolute voltage with respect to ground.

Pulse parameters: Two cross-hair cursors are used to define a region of interest for which pulse parameters will be calculated automatically.

Auto-setup

Pressing the auto-setup button automatically scales the time-base, trigger and sensitivity settings to provide a stable display for a wide range of repetitive input signals.

Type of signals detected: Repetitive signals with amplitudes between 2 mV and 8 V, frequency above 50 Hz and a duty cycle greater than 0.1%.

Auto-setup time: Approximately 2 sec.

Waveform Processing

Waveform processing routines are called and set up via menus. These include arithmetic functions (add, subtract and invert), and summation averaging (up to 1000 signals).

Pulse parameters: Based on ANSI/IEEE Std 181-1977 "Standard on Pulse Measurement and Analysis by Objective Techniques". The terminology is derived from IEEE Std 194-1977 "Standard Pulse Terms and Definitions".

Automatic measurements determine:

Maximum	Period
Minimum	Pulse width
Mean	Risetime
Standard deviation	Falltime
RMS	Delay

Sources: Chan1, Chan2, Memory C or D, Function E or F, Expand A or B. Cursors define the measurement zone. With more than 1 pulse present in the measurement zone, averaged results for period, width, risetime and falltime are presented.

Remote Control

Front-panel controls, including variable gain, offset, position controls and cursors, as well as all internal functions are programmable.

RS-232-C port: For computer/terminal control or plotter connection. Asynchronous up to 19200 baud.

GPIB port: (IEEE-488). Configured as talker/listener for computer control and fast data transfer. Address switches on rear panel.

Local/remote: Remote control can be interrupted for local (manual) control at any time (except when in remote control with the lock-out state selected) by pushing a button on the front panel.

Probes

Model: Two P9020 ($\times 10$, 10 M Ω // 3.33 pF) probes supplied.

Probe calibration: 1 kHz square wave, 1 V p-p.

Probe power: Two rear-panel power outlets for use with active probes provide ± 15 V, + 5 V DC.

Self Tests

Auto-calibration ensures accuracy of:

Overall DC accuracy: $\pm 2\%$ full scale at settings > 5 mV/div
 $\pm 3\%$ full scale at 5 mV/div

Time: 20 psec RMS.

General

Temperature: 5 to 40° C (41 to 104° F) rated; 0 to 50° C (32 to 122° F) operating.

Humidity: $< 80\%$.

Power required: 110 or 220 V AC, 45 to 440 Hz, 275 W.

Battery backup: Lithium batteries maintain front-panel settings and waveform data for 2 years.

Enclosure: (HWD) 19.2 \times 36.5 \times 46.5 cm, (7½ \times 14½ \times 19½ inch).

Weight: 15 kg (33 lbs) net, 20 kg (44 lb) shipping.

Warranty: 2 years.

Arabic numerals relate to the numbering scheme used to refer to front- and rear-panel controls and connectors in Figures 1 and 3 (9420) or Figures 2 and 3 (9450).

SAFETY INFORMATION

The oscilloscope has been designed to operate from a single-phase power source with one of the current-carrying conductors (neutral conductor) at ground (earth) potential. However, operation from power sources in which both current-carrying conductors are live with respect to ground (such as phase-to-phase on a tri-phase system) is also possible, as the oscilloscope is equipped with over-current protection for both mains conductors. None of the current-carrying conductors may exceed 250 V RMS with respect to ground potential. The oscilloscope is provided with a three-wire electrical cord containing a three-terminal polarized plug for mains voltage and safety ground connection. The plug's ground terminal is connected directly to the frame of the unit. For adequate protection against electrical hazard, this plug *must* be inserted into a mating outlet containing a safety ground contact.

The oscilloscope has not been designed to make direct measurements on the human body. Users who connect a LeCroy oscilloscope directly to a person do so at their own risk.

OPERATING VOLTAGE

The oscilloscope operates from a 115 V (90 to 132 V) or 220 V (180 to 250 V) nominal power source at 45 to 440 Hz. Prior to powering up the unit, make certain that the mains voltage for your area corresponds to the mains voltage value set on the oscilloscope. The currently set voltage is indicated by a green peg beside 115 V or 220 V on the **VOLTAGE SELECTOR** plate (60). If the indicated mains voltage differs from that used in your area, refer to Section 8, "The Rear Panel".

CAUTION

If a LeCroy oscilloscope set for 115 V is plugged into a 220 V power source, severe damage can occur. Before powering up the unit, ensure that the correct mains voltage has been set.

POWER ON

Check the items listed above. Connect the oscilloscope to the mains power using the mains cable supplied. The instrument may now be switched on by pressing the **POWER** (59) switch, located on the rear panel.

4 *Installation*

After switching on the instrument, auto-calibration is performed and a test of the oscilloscope's ADCs and memories is carried out. The full testing procedure takes approximately 15 seconds, after which time a display will appear on the screen. The intensity controls (12 and 13) may be adjusted to suit the user.

DISPLAY LAYOUT

In the following sections, Roman numerals in parentheses refer to the display field numbering scheme in Figure 6. Arabic numerals relate to the numbering scheme used to refer to front- and rear-panel controls and connectors in Figures 1 and 3 (9420) or Figures 2 and 3 (9450).

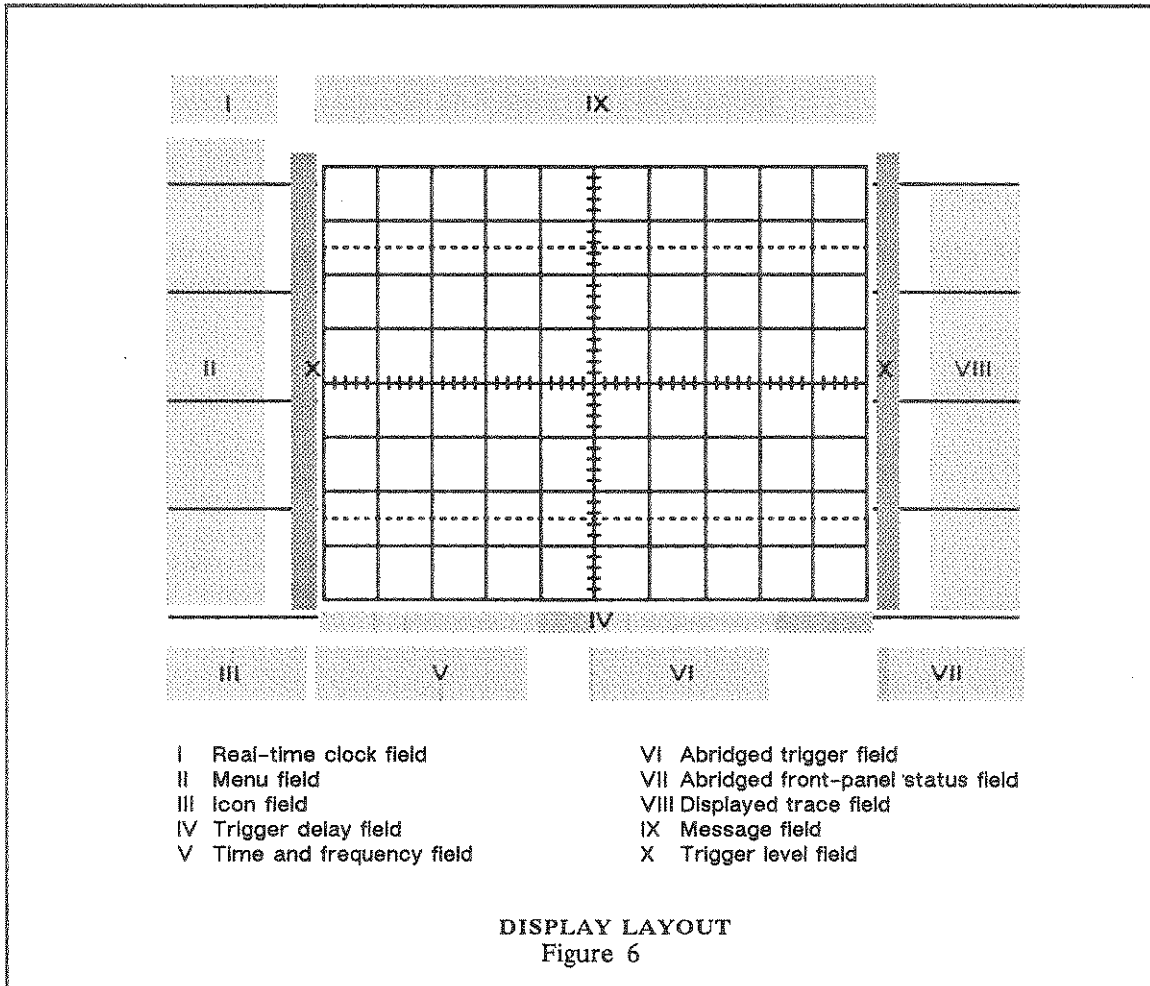

The CRT area is divided between the centrally located grid and ten other fields. Traces from the acquisition or reference memories are displayed on the grid. A dual-grid system is also available by pressing button (14).

5 Display Layout

The ten fields are used to display such information as interactive menu queries and responses, current acquisition parameters, relative and absolute time and voltage measurements, as well as messages to assist the user.

REAL-TIME CLOCK FIELD (I)

This field displays the current date and time.

MENU FIELD (II)

This field is divided into nine sub-fields associated with menu keys (2) through (10). Each field may display the name of a menu or perform an operation when the associated menu key is pressed. The lowest field and related Return button (10) are used to restore the higher menu level.

ICON FIELD (III)

This field indicates when the oscilloscope is in the process of making a screen dump. The icon disappears when the screen dump is finished.

TRIGGER DELAY FIELD (IV)

This field indicates one of the two trigger delay modes. In the pretrigger mode, an upward-pointing arrow appears below the bottom line of the trace display grid. It is adjustable from 0 to 10 divisions, corresponding to a 0 to 100% pretrigger setting.

In the post-trigger mode, this arrow is replaced by a leftward-pointing arrow next to the post-trigger indication (in decimal fractions of a second) at the bottom of the grid. The maximum post-trigger setting corresponds to 10000 screen divisions.

TIME AND FREQUENCY FIELD (V)

When the absolute time cursor (cross-hair marker) is activated, by using buttons (17) and (18), this field displays the time difference between the cross-hair marker and the point of triggering (common for all displayed traces).

When the relative time cursors (arrowhead cursors) are activated by using buttons (17) and (18), two readings are indicated. The upper reading indicates the time interval between the Reference and Difference arrowhead cursors, while the lower reading indicates the frequency corresponding to $1/(\text{time interval})$.

ABRIDGED TRIGGER CONFIGURATION FIELD (VI)

In the standard trigger mode, this field includes the trigger source, the trigger level and trigger coupling. A simple diagram, as shown in Figure 7, gives a visual overview of the trigger conditions.

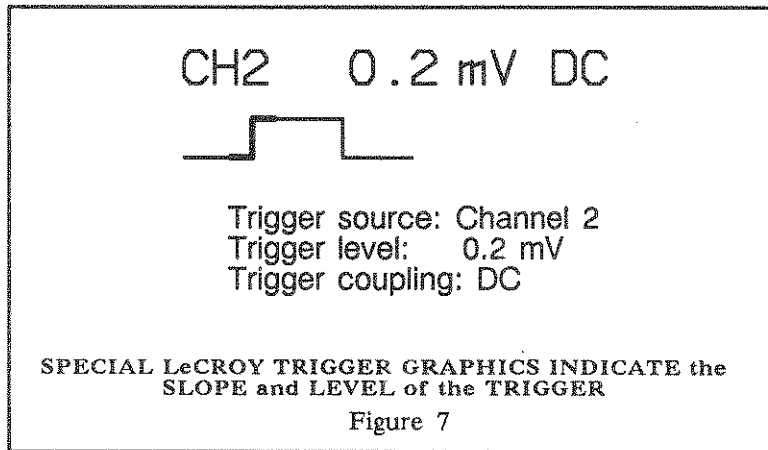

In the SMART trigger mode, the trigger source, level and coupling are listed. A diagram of the trigger configuration is given, as well as information on the logic states of Channel 1, Channel 2 and the external trigger source. The hold-off by time or number of events, the pulse or interval width, and the trigger delay are also specified.

ABRIDGED FRONT-PANEL STATUS FIELD (VII)

This is a short-form display of the data acquisition parameters, and is updated whenever the oscilloscope's front-panel controls are manipulated. This field indicates the vertical sensitivity of Channels 1 and 2, the input couplings and the time base.

DISPLAYED TRACE FIELD (VIII)

The Displayed Trace field is associated with buttons (49)-(54). The data displayed in this field are the identity of the displayed trace, and the time-base and sensitivity settings for the acquired signal, as well as an indication of the position of the VAR sensitivity vernier (30). The symbol ">" appears when the vernier is not in the detent position (i.e. not in the fully clockwise position). Whenever Measurement Cursors (16) and (17) are activated, absolute or relative waveform voltage data are displayed in this field.

In XY mode, at the right-hand side of the trace identifier, the trace assigned to the X axis is labelled "X", and the trace assigned to the Y axis is labelled "Y".

A frame around one of the upper six signal sources in the Displayed Trace field indicates which of the traces is to be acted upon during manipulation of the various display controls ((43) through (47)). When Dual Zoom expansion is ON, there are two frames

5 Display Layout

in the Displayed Trace field. A solid frame surrounds the currently selected expand function. The other expansion function is surrounded by a dashed frame.

MESSAGE FIELD (IX)

Messages appearing in this field indicate the oscilloscope's current acquisition status or report improper manipulation of the front panel controls. The following figure illustrates a typical message displayed in the Message field.

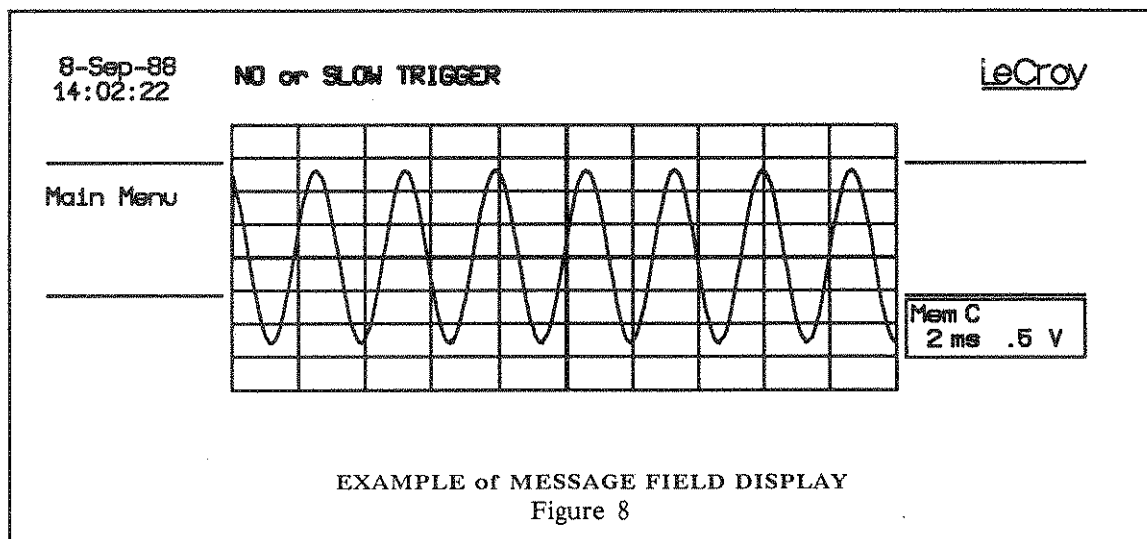

TRIGGER LEVEL

INDICATOR FIELDS (X)

Two indicators (▶ and ◀) on each side of the grid give a visual indication of the trigger level.

Note: In the following sections, Roman numerals in parentheses refer to the display field numbering scheme in Figure 6. Arabic numerals relate to the numbering scheme used to refer to front- and rear-panel controls and connectors in Figures 1 and 3 (9420) or Figures 2 and 3 (9450).

VERTICAL CONTROLS

CHANNEL 1 and CHANNEL 2 (25) – BNC type connectors are used for both Channel 1 and 2 signal inputs and the external trigger connector. The maximum permissible input voltage is 250 V (DC + peak AC).

Signal Coupling and Input Impedance buttons (24) – Select the method used to couple the signal to the vertical amplifier input.

Possible selections: AC, GND, DC with 1 M Ω impedance
GND (appears open, as seen from the outside)
DC with 50 Ω impedance.

In the AC position, signals are coupled capacitively, thus blocking the input signal's DC component and limiting the signal frequencies below 10 Hz.

In the DC position, all signal frequency components are allowed to pass through, and 1 M Ω or 50 Ω may be chosen as the input impedance. The user should note that with 1 M Ω input impedance the bandwidth is limited to approximately 250 MHz.

The maximum dissipation into 50 Ω is 0.5 W, and the inputs will automatically be disconnected whenever this occurs. A warning LED (OverId) lights up indicating when an overload condition has been detected. The input coupling LED (24) is simultaneously switched to GND. The overload condition is reset by removing the signal from the input and selecting the 50 Ω input impedance again.

VOLTS/DIV knob (29) – Selects the vertical sensitivity factor in a 1–2–5 sequence. The sensitivity range is 5 mV to 1 V/div at both 1 M Ω and 50 Ω input impedances when the VAR vernier (30) is in the detent position, i.e. turned fully clockwise.

The VOLTS/DIV (Figure 9) settings for Channel 1 and 2 are permanently displayed, along with the signal input coupling and the time-base setting, in the Abridged Front-panel Status field (VII) (Figure 6). The Volts/Div setting may be modified manually or via remote control, and is immediately updated.

6 Manual Operation

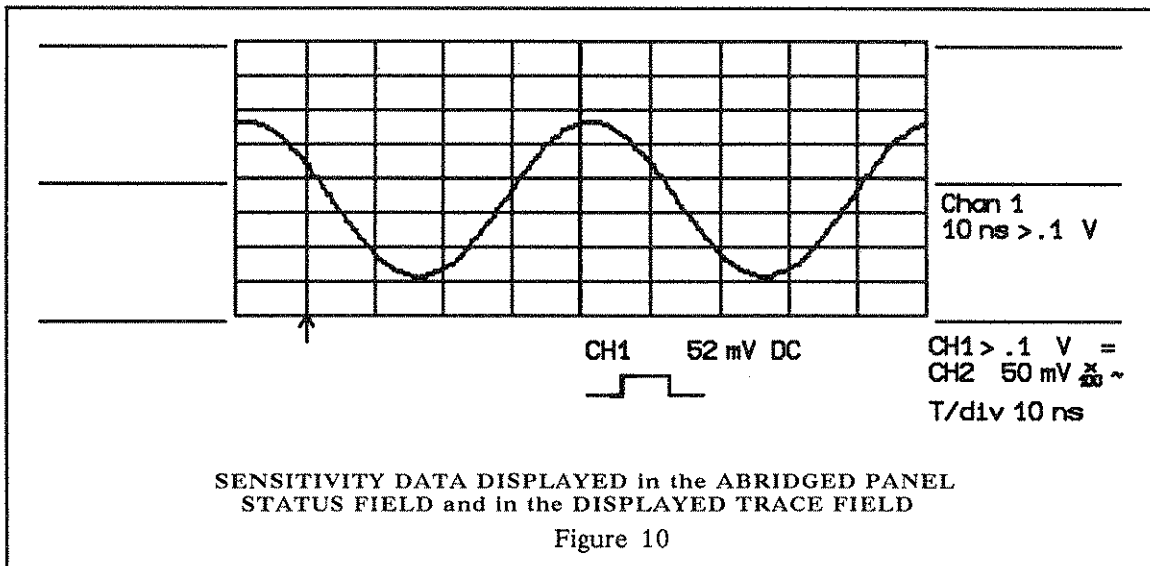
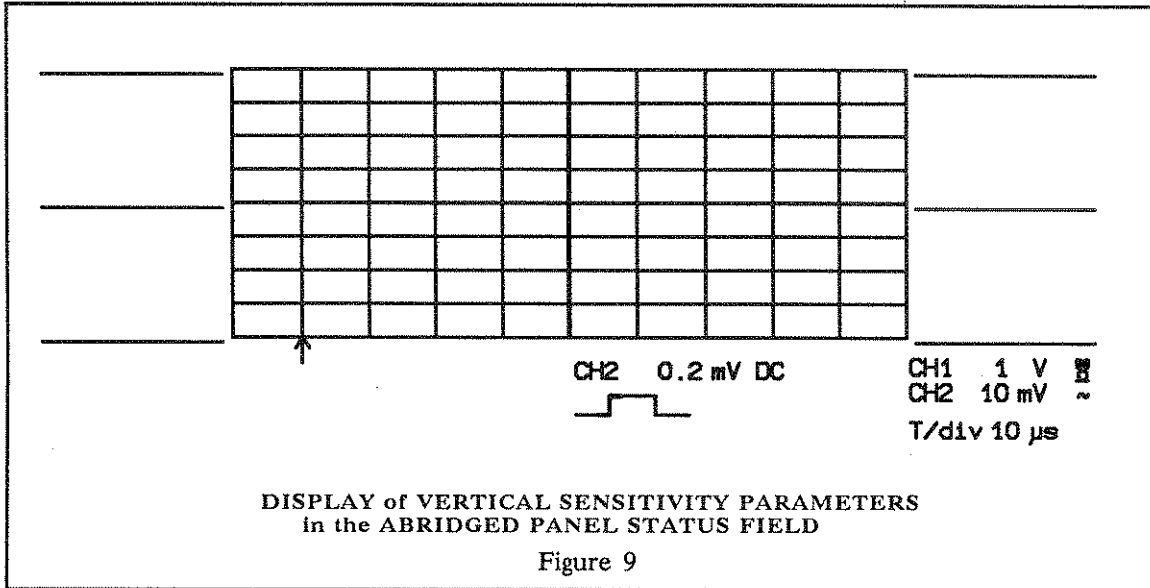

Whereas the acquisition control settings displayed in the Abridged Front-panel Status field (VII) are updated immediately upon manual or remote modification of the Volts/Div or Time/Division settings, the control settings in the Displayed Trace field (VIII), corresponding to the conditions under which the waveform was stored, are only updated with every waveform acquisition (Figure 10).

VAR knob (30) – Verniers provide continuously variable sensitivity within the Volts/Div settings and extend the maximum vertical sensitivity factor up to 2.5 V/div. Variable sensitivity settings are indicated by the symbol “>” in the lower portion of the Abridged Front-panel Status field and the calibrated value appears in the Total V/Div field of the Panel Status menu. (Minimum sensitivity is achieved by rotating the vernier counter-clockwise.)

VERTICAL OFFSET knob (34) – This knob vertically positions the displayed trace. At most of the voltage settings the maximum offset is ± 12 times the fixed sensitivity setting and is manually adjustable (or programmable) in 0.02 division increments. The maximum ranges depend on the fixed sensitivity setting as follows:

Fixed Sensitivity	Offset Range	Voltage
1 V	± 10 times	± 10 V
0.5 V to 20 mV	± 12 times	± 6 V to ± 240 mV
10 mV	± 24 times	± 240 mV
5 mV	± 48 times	± 240 mV

A pair of upward- or downward-pointing, double-shaft arrows indicate when the trace has been positioned outside the grid, as shown in Figure 11.

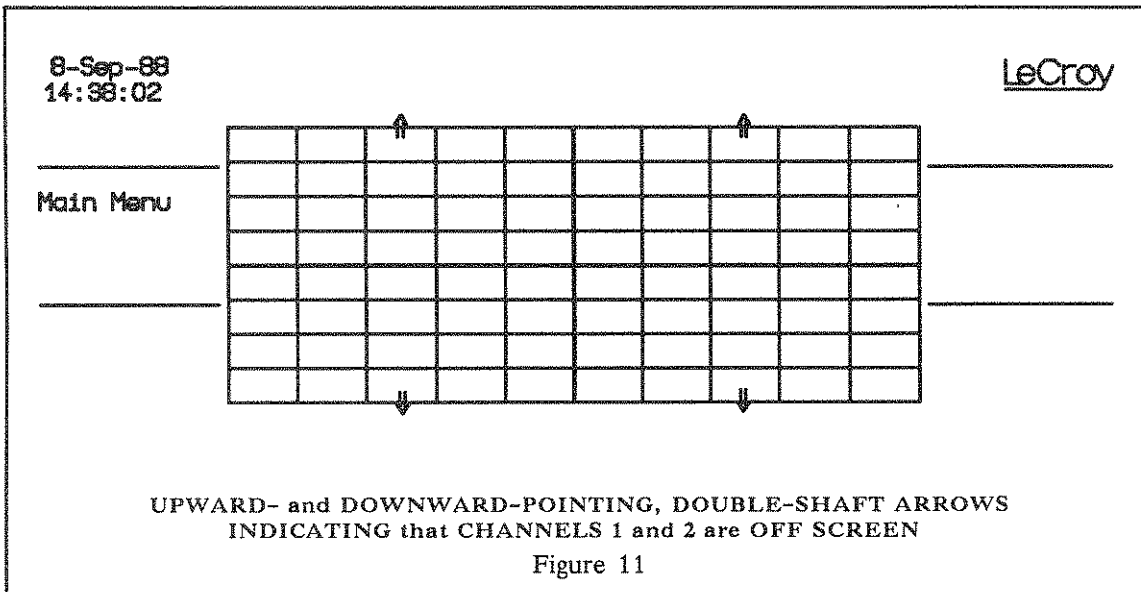

9420 TIME-BASE CONTROLS

TIME/DIVISION knob (41)– This control selects the time per division in a 1–2–5 sequence from 1 nsec to 5000 sec. The time base is displayed in the Abridged Front-panel Status field (VII) as well as in the Displayed Trace field (VIII). The time base is crystal-controlled and features an overall accuracy better than $\pm 0.01\%$.

Sampling Modes

Depending on the time-base setting, the following three sampling modes are possible with the 9420:

- * Random Interleaved Sampling (RIS)
- * Single Shot (SS)
- * Roll Mode

Random Interleaved Sampling (RIS): At time-base settings from 1 nsec/div to 20 μ sec/div, the 9420 always uses the RIS mode for signal acquisition. Repetitive waveforms and a stable trigger are required. Waveforms can be digitized with sample intervals as small as 100 psec for an equivalent sampling rate of up to 10 gigasamples/sec.

Between 50 nsec/div and 20 μ sec/div, the 9420 can operate in either RIS or single-shot modes. The user may select the RIS ac-

quisition mode by pressing the **Interleaved Sampling** button (40). When the LED is lit, the RIS mode is on.

Single Shot: Between 50 nsec/div and 20 μ sec/div, the user may select the single-shot acquisition mode by pressing the **Interleaved Sampling** button (40). When the LED is not lit the 9420 is in the single-shot mode.

The 9420 can record waveforms in a single acquisition for time-base settings between 50 nsec/div and 200 msec/div. Sampling rates up to 100 megasamples/sec are possible in the single-shot mode.

When the time base is set so that 200 or less points are acquired, the 9420 indicates the measured points by highlighting them and interpolating linearly between them.

Roll: From 500 msec to 5000 sec/div, the 9420 samples continuously. The display is rapidly updated using newly acquired data points which results in the trace moving from right to left in a manner similar to that produced by a strip-chart recorder.

6 Manual Operation

TIME BASE		SAMPLING RATE TIME/POINT		DISPLAYED RECORD LENGTH (Points)	
TIME/DIV		RIS	SS	RIS	SS
1	nsec	100 psec	---	100	---
2	nsec	100 psec	---	200	---
5	nsec	100 psec	---	500	---
10	nsec	100 psec	---	1000	---
20	nsec	100 psec	---	2000	---
50	nsec	100 psec	10 nsec	5000	50
0.1	μsec	100 psec	10 nsec	10000	100
0.2	μsec	100 psec	10 nsec	20000	200
0.5	μsec	100 psec	10 nsec	50000	500
1	μsec	250 psec	10 nsec	40000	1000
2	μsec	500 psec	10 nsec	40000	2000
5	μsec	1 nsec	10 nsec	50000	5000
10	μsec	2.5 nsec	10 nsec	40000	10000
20	μsec	5 nsec	10 nsec	40000	20000
50	μsec	---	10 nsec	---	50000
0.1	msec	---	25 nsec	---	40000
0.2	msec	---	50 nsec	---	40000
0.5	msec	---	0.1 μsec	---	50000
1	msec	---	0.25 μsec	---	40000
2	msec	---	0.5 μsec	---	40000
5	msec	---	1 μsec	---	50000
10	msec	---	2.5 μsec	---	40000
20	msec	---	5 μsec	---	40000
50	msec	---	10 μsec	---	50000
0.1	sec	---	25 μsec	---	40000
0.2	sec	---	50 μsec	---	40000
ROLL MODE					
0.5	sec	---	0.1 msec	---	50000
1	sec	---	0.25 msec	---	40000
2	sec	---	0.5 msec	---	40000
5	sec	---	1 msec	---	50000
10	sec	---	2.5 msec	---	40000
20	sec	---	5 msec	---	40000
50	sec	---	10 msec	---	50000
100	sec	---	25 msec	---	40000
200	sec	---	50 msec	---	40000
500	sec	---	0.1 sec	---	50000
1	ksec	---	0.25 sec	---	40000
2	ksec	---	0.5 sec	---	40000
5	ksec	---	1 sec	---	50000

LIST of SAMPLING MODES, SAMPLING RATE,
and DISPLAYED RECORD LENGTH for each 9420 TIME-BASE SETTING

Table 1

9450 TIME-BASE CONTROLS

TIME/DIVISION knob (41)— This control selects the time per division in a 1–2–5 sequence from 1 nsec to 5000 sec. The time base is displayed in the Abridged Front-panel Status field (VII) as well as in the Displayed Trace field (VIII). The time base is crystal controlled and features an overall accuracy better than $\pm 0.01\%$.

Sampling Modes

Depending on the time-base setting, the following three sampling modes are possible with the 9450:

- * Random Interleaved Sampling (RIS)
- * Single Shot (SS)
- * Roll Mode

Random Interleaved Sampling (RIS): At time-base settings from 1 nsec/div to 5 nsec/div, the 9450 always uses the RIS mode for signal acquisition. Repetitive waveforms and a stable trigger are required. Waveforms can be digitized with sample intervals as small as 100 psec for an equivalent sampling rate of up to 10 gigasamples/sec.

Between 10 nsec/div and 5 μ sec/div, the 9450 can operate in either RIS or single-shot modes. The user may select the RIS acquisition mode by pressing the **Interleaved Sampling** button (40). When the LED is lit, the RIS mode is on.

Single Shot: Between 10 nsec/div and 5 μ sec/div, the user may select the single-shot acquisition mode by pressing the **Interleaved Sampling** button (40). When the LED is not lit the 9450 is in the single-shot mode.

The 9450 can record waveforms in a single acquisition for time-base settings between 10 nsec/div and 5000 sec/div. Sampling rates up to 400 megasamples/sec are possible in the single-shot mode.

When the time base is set so that 200 or less points are acquired, the 9450 indicates the measured points by highlighting them and interpolating linearly between them.

Roll: From 500 msec to 5000 sec/div, the 9450 samples continuously. The display is rapidly updated using newly acquired data points which results in the trace moving from right to left in a manner similar to that produced by a strip-chart recorder.

6 Manual Operation

TIME BASE		SAMPLING RATE TIME/POINT		DISPLAYED RECORD LENGTH (Points)	
TIME/DIV		RIS	SS	RIS	SS
1	nsec	100 psec	---	100	---
2	nsec	100 psec	---	200	---
5	nsec	100 psec	---	500	---
10	nsec	100 psec	2.5 nsec	1000	40
20	nsec	100 psec	2.5 nsec	2000	80
50	nsec	100 psec	2.5 nsec	5000	200
0.1	μsec	100 psec	2.5 nsec	10000	400
0.2	μsec	100 psec	2.5 nsec	20000	800
0.5	μsec	100 psec	2.5 nsec	50000	2000
1	μsec	250 psec	2.5 nsec	40000	4000
2	μsec	500 psec	2.5 nsec	40000	8000
5	μsec	1 nsec	2.5 nsec	50000	20000
10	μsec	---	2.5 nsec	---	40000
20	μsec	---	5 nsec	---	40000
50	μsec	---	10 nsec	---	50000
0.1	msec	---	2.5 nsec	---	40000
0.2	msec	---	50 nsec	---	40000
0.5	msec	---	0.1 μsec	---	50000
1	msec	---	0.25 μsec	---	40000
2	msec	---	0.5 μsec	---	40000
5	msec	---	1 μsec	---	50000
10	msec	---	2.5 μsec	---	40000
20	msec	---	5 μsec	---	40000
50	msec	---	10 μsec	---	50000
0.1	sec	---	2.5 μsec	---	40000
0.2	sec	---	50 μsec	---	40000
ROLL MODE					
0.5	sec	---	0.1 msec	---	50000
1	sec	---	0.25 msec	---	40000
2	sec	---	0.5 msec	---	40000
5	sec	---	1 msec	---	50000
10	sec	---	2.5 msec	---	40000
20	sec	---	5 msec	---	40000
50	sec	---	10 msec	---	50000
100	sec	---	25 msec	---	40000
200	sec	---	50 msec	---	40000
500	sec	---	0.1 sec	---	50000
1	ksec	---	0.25 sec	---	40000
2	ksec	---	0.5 sec	---	40000
5	ksec	---	1 sec	---	50000

LIST of SAMPLING MODES, SAMPLING RATE,
and DISPLAYED RECORD LENGTH for each 9450 TIME-BASE SETTING

Table 2

PROBES

Two Model P9020 passive probes are supplied with the 9420/50 oscilloscope. These probes have 10 M Ω input impedance and 16 pF capacitance. The system bandwidth with P9020 probes is DC to 250 MHz (typical) in 1 M Ω DC coupling, and < 10 Hz to 250 MHz in AC coupling. Active FET probes (Tektronix models P6201, P6202a and P6230) may be powered via probe power connectors on the rear panel.

PROBE CALIBRATOR outputs (22), (23)– To calibrate the probe, connect it to the **Channel 1** or **Channel 2** BNC connector (25). Connect the probe's grounding alligator clip to the front panel ground lug (23) of the oscilloscope and connect the tip to lug (22).

Adjust the oscilloscope's front-panel controls as described in Section 9. If over- or undershooting of the displayed signal occurs, it is possible to adjust the probe by inserting the small screwdriver, supplied with the probe package, into the trimmer on the probe's barrel and turning it clockwise or counter-clockwise to achieve the optimal square-wave contour.

BANDWIDTH LIMIT

By setting the **Bandwidth Limit** button (54) to ON, the bandwidth can be reduced from 350 MHz to 80 MHz (-3 dB). Bandwidth limiting may be useful in reducing signal and system noise or preventing high-frequency aliasing. For example, bandwidth limiting reduces any high-frequency signals that may cause aliasing in single-shot applications using time-base settings faster than 20 μ sec/division.

**TRIGGER CONTROLS
(STANDARD)**

Two basic trigger modes are available in the 9420/50. The standard trigger facilities are described below. For a full description of the SMART trigger facilities refer to Section 7.

The standard trigger has a single source and is completely controlled from the front panel. SMART trigger functions are selected by pressing the **SMART Trigger** (35) button which switches "ON" the trigger status LED. Pressing the **SMART Trigger** (35) button again, switches off the LED and returns the oscilloscope to standard trigger control. SMART trigger functions are inspected and modified using a display menu.

This section includes full details of how the standard trigger is configured and deals with the following:

- Trigger sources
- Trigger coupling
- Trigger adjustment (delay, level and slope)
- Trigger mode
- Trigger status
- Standard trigger graphics

Trigger Sources

EXTERNAL trigger input (27)– Accepts an external trigger signal of up to 250 V (DC + peak AC). Input impedance is 1 M Ω in parallel with < 20 pF. The maximum trigger rate exceeds 500 MHz when HF coupling is selected.

TRIGGER SOURCE buttons (26)– Allow the trigger source to be selected as follows:

CHAN 1: Selects Channel 1 as the trigger source, i.e. the signal connected to the Channel 1 BNC input connector (25).

CHAN 2: Selects Channel 2 as the trigger source, i.e. the signal connected to the Channel 2 BNC input connector (25).

LINE: Selects the line voltage which powers the oscilloscope to provide a stable display of signals synchronous with the power line.

EXT: With the **Trigger Source** set to **EXT** a signal applied to the BNC connector labeled **External** (27) is used to trigger the scope within a range of ± 2 V.

EXT/10: With the **Trigger Source** set to **EXT/10**, a signal applied to the BNC connector labeled **External** (27) is used to trigger the scope within a range of ± 20 V.

Trigger Coupling

TRIGGER COUPLING buttons (32)– Select the type of signal coupling at the input of each trigger circuit. Note that the trigger coupling can be adjusted independently for each trigger source. Therefore, a change of the trigger source may also result in a change of the trigger coupling LEDs since the coupling associated with the newly selected source is remembered.

HF: Used for triggering on high frequency repetitive signals in excess of 300 MHz. Maximum trigger rates greater than 500 MHz are possible. **HF** triggering should be used only when needed. This coupling is automatically set to **DC** if it is incompatible with the trigger mode, for example when pulse or interval width triggering or TV trigger is being used (see Section 7). Only a positive trigger slope is possible.

AC: Signals are capacitively coupled; DC levels are rejected and frequencies below 50 Hz are attenuated.

LF REJ: Signals are coupled via a capacitive high-pass filter network. DC is rejected and signal frequencies below 50 kHz are attenuated. The **LF REJ** trigger mode is used when stable triggering on medium to high frequency signals is desired.

HF REJ: Signals are DC coupled to the trigger circuit and a low-pass filter network attenuates frequencies above 50 kHz. The **HF REJ** trigger mode is used to trigger on low frequencies.

DC: All of the signal's frequency components are coupled to the trigger circuit. This coupling mode is used in the case of high frequency bursts, or where the use of AC coupling would shift the effective trigger level.

Trigger Adjustment (Delay, Level and Slope)

The **TRIGGER ADJUST** knob (37) together with button (39) is used to adjust the **Trigger Delay** and **Trigger Level** settings as explained below:

TRIGGER DELAY button (39)– is used to select the **Trigger Delay** function which adjusts the amount of pre- or post-trigger delay required when recording signals. This function is active only when the **Delay LED** is lit. The required delay is set using the continuously rotating **Trigger Adjust** knob (37). Turning this knob slowly allows fine adjustment of the trigger point; turning it quickly results in rapid trigger point movement. Note that the value of the trigger delay applies to all the trigger sources.

Pretrigger adjustment up to 100% full scale, in steps of 0.2% is available with the 9420/50. The value is displayed in % in the **Panel Status** display (press button (2) in the **Main menu**) and indicated on the grid by the position of an upward-pointing arrow, ↑, in the **Trigger Delay** field (IV).

Post-trigger adjustment is possible up to 10,000 divisions in 0.02 division increments. A post-trigger delay is indicated by a leftward-pointing arrow, ←, in the left-hand corner of the **Trigger Delay** field (IV). The exact delay in seconds is specified beside the upward-pointing arrow in the **Trigger Delay** field (IV).

ZERO button (38)– When the **Trigger Delay** function is selected, the **Zero** function resets the trigger delay from previously set positions to the farthest left grid line (i.e. 0.0% Pretrigger position).

TRIGGER LEVEL button (39)– This function adjusts the required voltage level of a signal which is being used to generate a trigger and is active only when the **Level LED** is lit. The required level is set via the **Trigger Adjust** knob (37). The level can be

adjusted independently for each trigger source. Note that the trigger level is specified in volts and is normally unchanged when the vertical gain or offset is modified.

The range of trigger levels is as follows:

± 5 screen divisions – with CHAN 1 or CHAN 2 as trigger source

None with LINE as trigger source (zero-crossing is used)

± 2 V with EXT as trigger source

± 20 V with EXT/10 as trigger source

ZERO button (38)– When the **Trigger Level** function is selected, the **Zero** button may be used to reset the trigger level from a previously set value to 0.0 V.

SLOPE button (31)– Selects the signal edge used to activate the trigger circuit. The slope of the trigger can be adjusted for each individual trigger source and is indicated by LEDs.

POS– Requires a positive-going edge of the trigger signal.

NEG– Requires a negative-going edge.

Trigger Mode

TRIGGER MODE buttons (28)– Select the mode of trigger operation as follows:

SINGLE (HOLD)– Selected using the lower button (28).

In this mode, the oscilloscope digitizes continuously until a valid trigger is received. When the waveform has been acquired and displayed, no further signals can be acquired until the **Single (Hold)** button has been pressed again to re-arm the trigger circuit for the next trigger signal. This type of acquisition provides a standard means of recording a wide variety of transient events. If a trigger does not occur and the **Single** button is pressed, the oscilloscope returns to its triggered state and displays the last valid waveforms.

When the 9420/50 is in the Random Interleaved Sampling (RIS) mode, a sufficient number of triggers are acquired to complete waveform reconstruction, after which the waveform will then be displayed. No further signals can be acquired until the **Single (Hold)** button has been pressed again. If the **Single (Hold)** button is pressed while a RIS waveform is being acquired, the acquisition is halted and partial waveform reconstruction is performed.

When the oscilloscope is in the roll mode (≥ 500 msec/

div), pressing the **Single (Hold)** button causes data acquisition to stop immediately and the display to freeze. The acquisition can be continued by pressing the button again.

NORM- Selected using buttons (28).

When in the normal (**Norm**) trigger mode the oscilloscope continuously digitizes the input signal. Whenever a valid trigger is received, the acquired waveform is displayed on the screen, digitization recommences and the trigger circuit is re-armed. If no subsequent trigger is received within 2 seconds, the warning

“NO or SLOW TRIGGER”

is displayed in the Message field (IX). Because the oscilloscope features non-volatile front-end memory, the last waveform acquired is always stored and displayed.

When the time base is in the **RIS** mode, a sufficient number of valid triggers (typically between 200 and 400) is required for each display of a complete waveform.

In the roll mode (≥ 500 msec/div), the 9420/50 samples the input signals continuously. The display is rapidly updated using newly acquired data points which results in the trace moving from right to left in a manner similar to that produced by a strip-chart recorder. After the trigger has been received, the acquisition will be completed and the display will pause while showing the acquired waveform. After a moment it will go back into the roll mode while it waits for the next trigger. The acquisition can be halted at any time by pressing the **Single (Hold)** button (28).

AUTO- Selected using buttons (28).

This mode resembles the **Norm** mode, except that it automatically generates an internal trigger whenever the selected trigger is missing for more than 500 msec. When the oscilloscope auto-triggers, the display usually moves in time as the trigger is not time-correlated with the input signal.

Auto-trigger in the **RIS** mode will force the display of the acquired waveform every quarter of a second even if the reconstruction is incomplete.

When the 9420/50 is in the roll mode (≥ 500 msec/div), it samples input signals continuously. In the Auto mode this continues indefinitely. The only way to stop the acquisition is to change the trigger mode.

SEQNCE- Selected using top button (28).

Sequence triggering enables the user to partition the 9420/50's acquisition memories into 2, 5, 10, 20, 50, 100, or 200 segments. Waveform acquisition in the **SEQNCE** mode is particularly useful in the case of short-lived or echoed signals, such as those typically encountered in radar, sonar, lidar and NMR.

In the sequence mode the time-base setting determines the total duration (time/div \times 10) of each segment. Changing the number of required segments does not change the time base; it only affects the number of digitized points (record length) per segment. The number of data points per division is shown in the Panel Status menu.

The display is updated only after all the individual segments have been acquired. If less than the required number of triggers is available, the sequence acquisition may be aborted by pressing the **Seqnce** button (28) again.

To rearm the oscilloscope to capture a second group of sequentially stored waveforms simply press the **Seqnce** button (28) again.

Number of Segments	Points/Segment 20 msec/div	Points/Segment Maximum
2	20000	20000
5	8000	10000
10	4000	5000
20	2000	2000
50	800	1000
100	400	500
200	200	200

SEQUENCE TRIGGER MODE: NUMBER OF SEGMENTS VS. RECORD LENGTH (time base 20 msec/div). THE NUMBER OF POINTS/SEGMENT IS TIME-BASE DEPENDENT

Table 3

Neither the Channel 1 nor 2 display is updated when the oscilloscope has terminated an acquisition in the **Single** or **Seqnce** trigger

mode, i.e. no further data are acquired. Vertical positioning of the displayed trace may still be modified via the **Offset** control (34) and the **VAR** vernier (30) also remains active. However, no other parameter modifications, such as vertical sensitivity, trigger or time-base changes, will alter the display of a currently acquired waveform in Channel 1 or 2.

When the 9420/50 is in **Single** or **Seqnce** mode and has finished acquiring data, all the parameters may be modified by manipulating the appropriate front-panel controls, but such modification – indicated by parameter changes in the Abridged Front-panel Status field (VII) – will only be taken into account when the next trace is being acquired.

Whenever the oscilloscope is in the **Norm** or **Auto** trigger modes, data are continuously acquired and a display is rapidly generated. Adjustment of the front-panel controls will cause prompt changes in the acquisition parameters and immediate waveform acquisition with the new settings.

Trigger Status

TRIGGER STATUS, **TRIG'D** and **READY** LEDs (33)– The **Trig'd** LED indicates that an acquisition has been completed (normally after a valid trigger).

The **Ready** LED indicates that the trigger circuit has been armed and that the oscilloscope is currently digitizing input signals. When it receives a valid trigger signal, it will continue digitization until the other trigger delay conditions, such as trigger delay, have been satisfied and will then display the acquired waveform. In **RIS**, at slow trigger rates, the trigger LED lights up when intermediate acquisitions occur. This feature helps to monitor the behavior of the waveform even before the waveform is reconstructed.

Trigger Symbols

To allow immediate recognition of the current trigger conditions, the oscilloscope displays a special set of trigger graphics, which appear in the Front-panel Status field (VII). Some examples of the standard trigger symbols are given in Figure 12. An extended set of symbols for the **SMART** trigger may be found in Section 7.

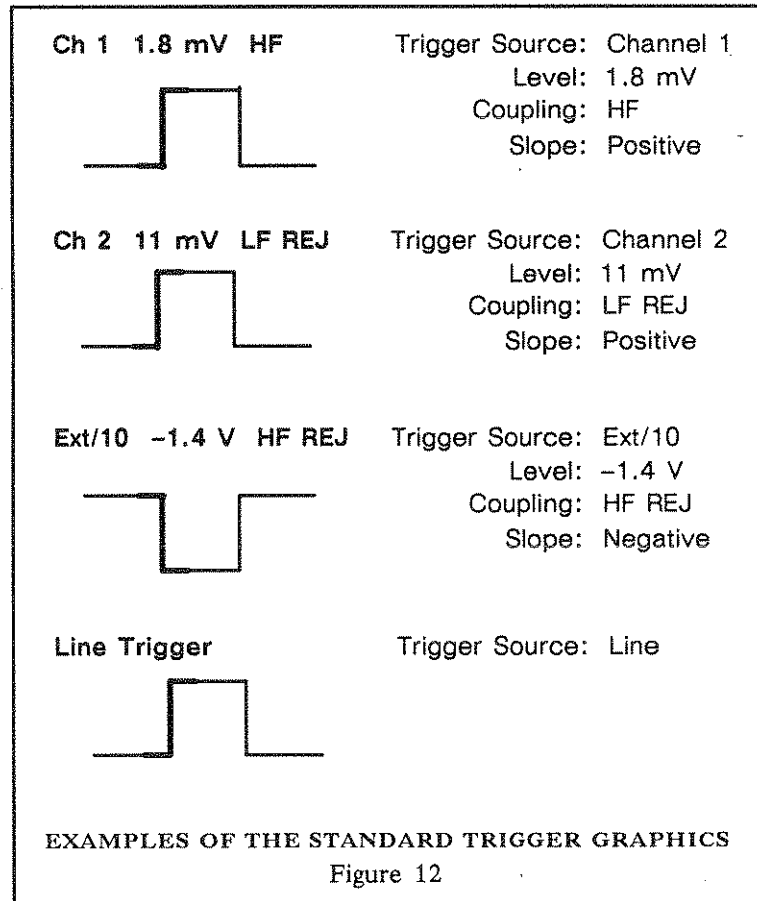

DISPLAYING TRACES

Up to four different waveforms (out of a total of eight) may be simultaneously displayed. To display a waveform, press the corresponding **Trace On/Off** buttons ((50) through (53)). The waveform will then appear on the screen together with a short description in the **Displayed Trace** field (VIII). When several signals are displayed simultaneously, buttons (50)–(53) can also be used as convenient trace identifiers. Pressing one of these buttons will make the selected trace turn off and on again.

EXPAND A, B buttons (50)– Turn the displayed expansion of a waveform ON or OFF. The expanded portion of a waveform is shown on the source trace as an intensified region. The default settings are; Expand A which operates on Channel 1 and Expand B which operates on Channel 2. The default settings may be modi-

fied to allow expansion of any other source trace by using the **Redefine** button (48), and choosing the required source to expand using the menu buttons (2) through (7).

MEMORY C, D buttons (51)– Turn the display of a waveform stored in reference Memories C or D ON or OFF. Data from any of the waveform storage locations, Channels 1 and 2, Expand A and B and Functions E and F may be stored into these memories by pressing the **Store** button (1). Press the button corresponding to the required source and then choose either **Mem C** or **D** as required.

FUNCTION E, F buttons (52)– Turn the display of a computed waveform ON or OFF. The type of computation may be defined by pressing the **Redefine** button (48).

CHANNEL 1, 2 buttons (53)– Turn the display of signals applied to either of the input connectors (25) ON or OFF. Data are always recorded simultaneously into the Channel 1 and Channel 2 acquisition memories, irrespective of whether the trace displays are ON or OFF.

DISPLAY CONTROL AND EXPANSION

Before waveform acquisition the Channel 1 and Channel 2 traces are controlled by the **Vertical** and **Time/Division** controls ((29), (30), (34) and (40), (41) respectively).

Displayed traces may be modified within certain limits following waveform acquisition.

EXPAND A, B (50), **Memory C, D** (51), and **Function E, F** (52), are controlled by the **Display Control** knobs and buttons (43) through (49). Only one trace can be controlled at a time. The identity of the controlled trace is indicated by a rectangular frame around the waveform descriptor in the **Displayed Trace** field (VIII).

Whenever more than one of the six traces listed above is currently displayed, the frame may be moved to the next trace by pressing the **Select** button (49).

HORIZONTAL POSITION knob (43)– Horizontally positions an expanded waveform and the intensified region along the source trace. This control is activated only after the **Expand A** and/or **B** buttons (50) have been pressed to display the expanded trace. The **Horizontal Position** knob allows the user to scroll continuously through a displayed waveform.

When the waveform source is a sequence waveform, two additional options appear in the root menu. They can be used to change between segments of a sequence acquisition while keeping a constant expansion factor and position. If the buttons are

pressed continuously, the display will rapidly move from one segment to the next. This capability can also be used with the dual zoom feature.

The **Horizontal Position** knob affects only **Expand A** and **B**.

VERTICAL POSITION knob (44)– Vertically repositions the trace.

RESET button (45) – Resets any previously adjusted **Vert Gain**, **Vertical** and/or **Horizontal Position** settings to the following default values:

VERT GAIN – Same as the original trace

VERTICAL POSITION – Same as the original trace

HORIZONTAL POSITION – Center of the original trace

In the dual zoom expansion mode (see below), this button is used to synchronize the two intensified regions of **Expand A** and **B**.

VERT GAIN knob (46)– Turning the knob clockwise enables vertical expansion by a factor of up to 5. Counterclockwise rotation enables vertical contraction by a factor of up to 5. When operating on processed waveforms the maximum **Vert Gain** magnification is increased from 5 to 10.

Pressing **RESET** button (45)– Returns gain control to a mid-range plateau corresponding to a gain of 1.

TIME MAGNIFIER knob (47)– Horizontally expands waveforms by a factor of up to 1000 and operates on **Expand A** and **B** only.

Overall timing accuracy and resolution is improved at higher magnification factors. The expand function is controlled digitally and makes use of the oscilloscope's high number of recorded data points. Dot-linear graphics are used for the display of highly expanded waveforms. This technique highlights the position of actual data points, allowing them to be easily identified, and connects the data using linear interpolation.

SELECT button (49)– Chooses one of the traces, **Expand A** through **Function F**, to be controlled via the **Display Control** knobs and buttons ((43)–(48)). The selected trace is indicated by a rectangular frame around the waveform descriptor in the **Displayed Trace** field (VIII). Pressing the **Select** button (49) moves the rectangle to the next displayed trace in a rolling sequence.

REDEFINE button (48)– Changes the source (Channel 1, 2, Memory C,D, Function E or F) of either **Expand A** or **B**. When either **Expand A** or **B** is selected, pressing the **Redefine** button (48) produces a menu on the left-hand side of the screen. Buttons

(2) through (7) are then used to change the source signal. The default sources are **Chan 1** for **Expand A** and **Chan 2** for **Expand B**.

It is not possible to redefine Memories C and D.

When either **Func E** or **Func F** are selected, pressing the **Redefine** button calls up the associated configuration menu to inspect or modify the function definition.

Dual Zoom Expansion

Independent expansion of single traces to display a magnified portion of the waveform from Channels 1 and/or 2, Memories C and/or D, or of Function E and/or F is discussed above. However, in certain applications, it is convenient to be able to move the intensified region along two different traces, or two regions of the same trace, simultaneously.

To use the **Dual Zoom** expansion facility, switch both **Expand A** and **Expand B** ON. Press the **Return** button (10) until the oscilloscope is in the root menu, i.e. the **Main Menu** option appears in the Menu field (II). Beside button (5), **Dual Zoom** is indicated as being either ON or OFF (Figure 13). Use button (5) to set the **Dual Zoom** feature as required:

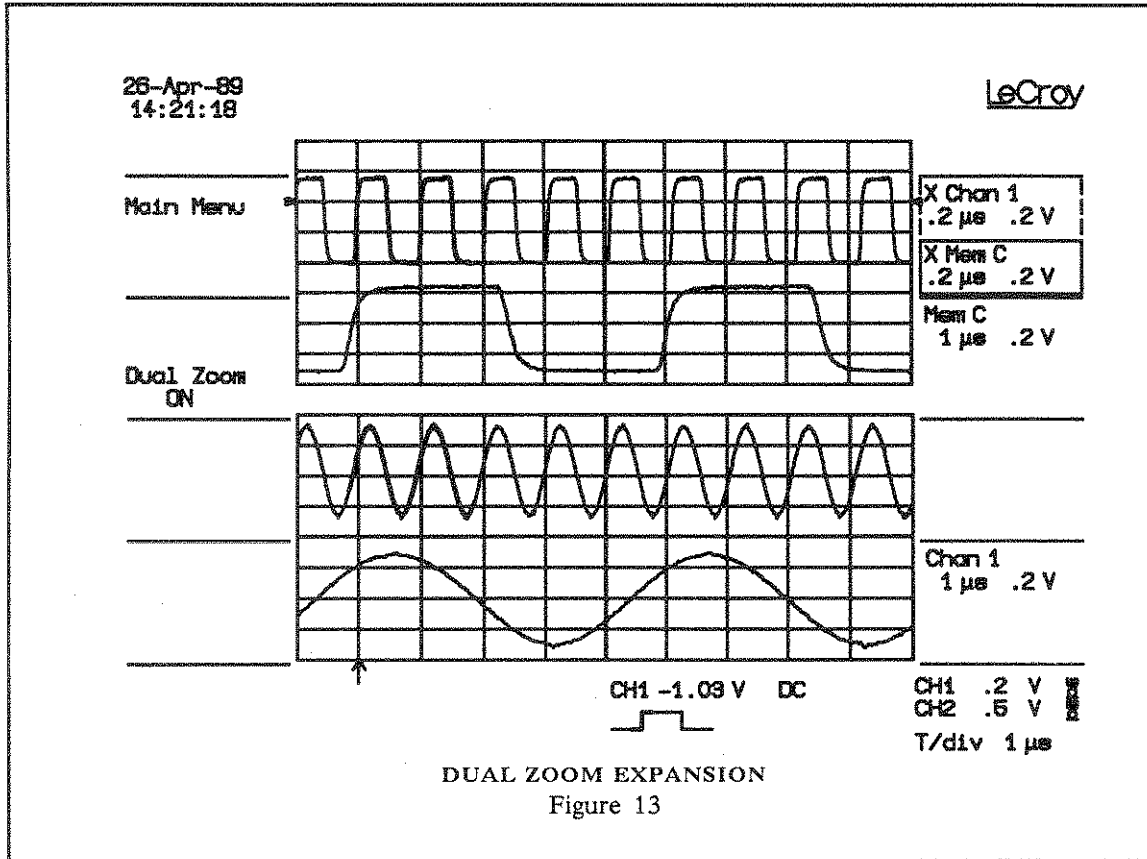

When Dual Zoom expand is ON, selecting either Expand A or Expand B with the Select button (49) will result in the usual frame around the selected expand function and a dashed frame around the other. Even when menus are being shown in the Menu field, this indicates when Dual Zoom is ON.

When Dual Zoom expand is ON, it is possible to either synchronize the intensified regions of the two source signals, or to maintain a fixed time interval between them. The intensified regions will move horizontally at a fixed interval of separation. (See Section 9 for an example of intensified regions moving on two different traces expanded in the Dual Zoom expansion mode.)

In the Dual Zoom Expansion mode, only the Horizontal Position control (43) and Time Magnifier control (47) act simultaneously on the intensified regions on both the Expand A and B signal

source, while the **Vert Gain** control (46) and **Vertical Position** control (44) act independently on each expanded waveform.

Note that when the **Dual Zoom** expansion mode is used, the **Expand A** magnification factor applies to both **Expand A** and **B**.

STANDARD WAVEFORM PROCESSING

All waveform processing occurs through **Functions E** and **F** and may be displayed on the screen by pressing the corresponding **Function E, F** (52) button. Whenever the **Function E** or **F** trace, or an expansion of one or both of these traces (in **Expand A** or **B**), is turned ON, the corresponding waveform processing is executed. Whenever the trace (and its expansion) is turned OFF, the continuous processing is suspended.

Functions E and F are waveforms that exist independently of (i.e. in addition to) the acquisition memories of Channels 1 and 2 and of the reference Memories C and D. On the display, they are treated similarly to Memories C and D, i.e. the vertical display gain and the vertical position can be modified, but not the horizontal position and the time magnifier. Of course, they can be expanded by redefining the source waveform of the traces **Expand A** or **B**.

Channel 1 and Channel 2 are the only possible sources for the standard waveform processing functions. However, for oscilloscopes fitted with additional processing options (WP01 and WP02), **Expand A**, **Expand B**, **Function E** and **Function F** may also be used as sources.

Waveform processing can take an appreciable execution time when operating on many data points. The user has the option of reducing the execution time by limiting the number of data points which are used in the computation.

The 9420/50 then executes the waveform processing function on the entire waveform by taking every N^{th} point, N depending on the time base and the desired maximum number of points. The first point of such a reduced record is always the data value at address 0 (i.e. the point on the left-hand edge of the screen).

Setting Up a Waveform Processing Function

It is generally good practice to stop data acquisition while preparing new conditions for waveform processing (by setting the trigger mode to **Single Trig'd**) because the response time might otherwise be slow, depending on the current function setup. In order to prepare **Function E** or **F** for new conditions, or to inspect the current setup, the trace **Function E** or **F** (52) must be turned ON. Select this trace for display control with the **Select** button (49) and press **Redefine** (48). A full-page setup menu for this function appears on the screen. To return to the waveform display, press either the **Return** button (10) or the **Redefine** button (48).

The currently selected processing function and its parameters may be modified with the soft keys (2) to (5). First select the field to be modified. The rectangular frame around parameter values indicates the currently selected field. Pressing the **Previous Field** button (2) will cause the frame to move towards the top of the list, whereas pressing the **Next Field** button (3) will cause the frame to move downwards. The **Reference** knob (42) can also be used to move the frame from one field to another. Note that the options available in each field are listed in the frame in the lower right corner of the screen.

Following field selection, the current value of the field may be modified by pressing either the **Previous Value** or **Next Value** button (6) or (7) or turning the **Difference** knob (42). Since the identity of the lower fields may depend on the function chosen, modify the parameters from top to bottom.

The following waveform processing functions are available:

- Average: summed
- Arithmetic: Identity, Negation, Addition, and Subtraction

Available Functions

Summed Average: Summed averaging consists of the repeated addition, with equal weight, of recurrences of the source waveform. Whenever the maximum number of waveforms is reached, the averaging process stops. The averaging process may be interrupted by switching the trigger mode from **Norm** to **Single** (28) or by turning the function trace **OFF** (52). Averaging will continue when these actions are reversed.

The currently accumulated average may be reset by changing an acquisition parameter, such as input gain, offset or coupling, trigger condition or time base. The number of currently averaged waveforms is displayed in the **Displayed Trace** field (VIII) of the corresponding function or of its expansion.

Whenever the maximum number of sweeps is reached, a larger number of sweeps may be accumulated by simply changing the maximum number of sweeps in the setup menu. In this case, care must be taken to leave the other parameters unchanged, otherwise a new averaging calculation will be started.

Summed averaging may be performed over channel 1 or 2.

Arithmetic: Addition/subtraction consist of addition/subtraction of two source waveforms on a data point per data point basis. Different vertical gains and offsets of the two sources are automatically included in the calculation.

Negation is performed on a single source trace which is inverted.

Identity causes a waveform to be stored in one of the function memories. The number of data points can be reduced by changing the maximum number of points allowed.

SCREEN ADJUSTMENTS

INTENSITY knob (12)– Adjusts the intensity of the displayed trace and all alphanumeric readouts and messages. The **Intensity** control may be adjusted in either manual or programmed control mode.

GRID INTENSITY knob (13)– Controls grid intensity independently of displayed trace intensity.

DUAL GRID button (14)– Switches between single- and dual-grid displays. The dual grid is useful when displaying multiple traces, in which case Channel 1 is permanently assigned to the upper grid and Channel 2 to the lower grid. All other displayed traces may be repositioned anywhere on the screen using the **Vertical POSITION** control (44).

SCREEN DUMP button (11)– Dumps the contents of the screen onto an on-line digital plotter or dot matrix printer, via the oscilloscope's rear-panel GPIB or RS-232-C interface ports, and provides color or monochrome hard copy archiving of the display. All the screen illustrations included in this manual were produced using the **Screen Dump** function.

Once the **Screen Dump** button has been pressed, *all* the displayed information will be plotted. It is possible to plot waveforms without also plotting the grid by turning the **Grid Intensity** knob fully counterclockwise.

While a screen dump is taking place, as indicated by the plot graphic on the lower left-hand side of the screen, it can be aborted by pressing the **Screen Dump** button a second time. Allow some time for the plotter buffer to empty before plotting stops.

While a plotter screen dump operation is in progress, new waveforms may be captured, processed and displayed. During a screen dump onto a printer, other operations are suspended.

CURSORS

Cursor measurements of absolute and relative voltage and time, may be made simultaneously on up to four traces on the oscilloscope's CRT.

The cursor system for the XY Mode is explained in the XY Mode Section.

Voltage Measurement

VOLTAGE Cursor button (16)– Is used in conjunction with the **Relative/Absolute** button (18).

When **Relative** measurement is selected, two horizontal cursor bars allow accurate differential voltage measurements. The vertical position of the horizontal bars may be adjusted on the single- or dual-grid displays using the **Reference** and **Difference** controls (42).

Pressing the **Tracking** button (42) causes the difference cursor to track the reference cursor at a fixed interval as determined by the **Difference** control. A vertical bar will appear on the left edge of the grid between the reference and difference voltage bars. The length of the bar indicates the tracking interval.

When **Absolute** measurement is selected, a single horizontal cursor bar allows accurate voltage measurement with respect to the **GROUND** reference level. This horizontal bar may be repositioned using the **Reference** control (42). Positioning the bar at the 0.0 V position provides an accurate representation of the reference **GROUND** level. The results of the relative voltage measurements appear for each displayed trace in its associated **Displayed Trace** field, in place of the usual time-base and sensitivity settings.

Voltage cursor bars are displayed in Figure 14.

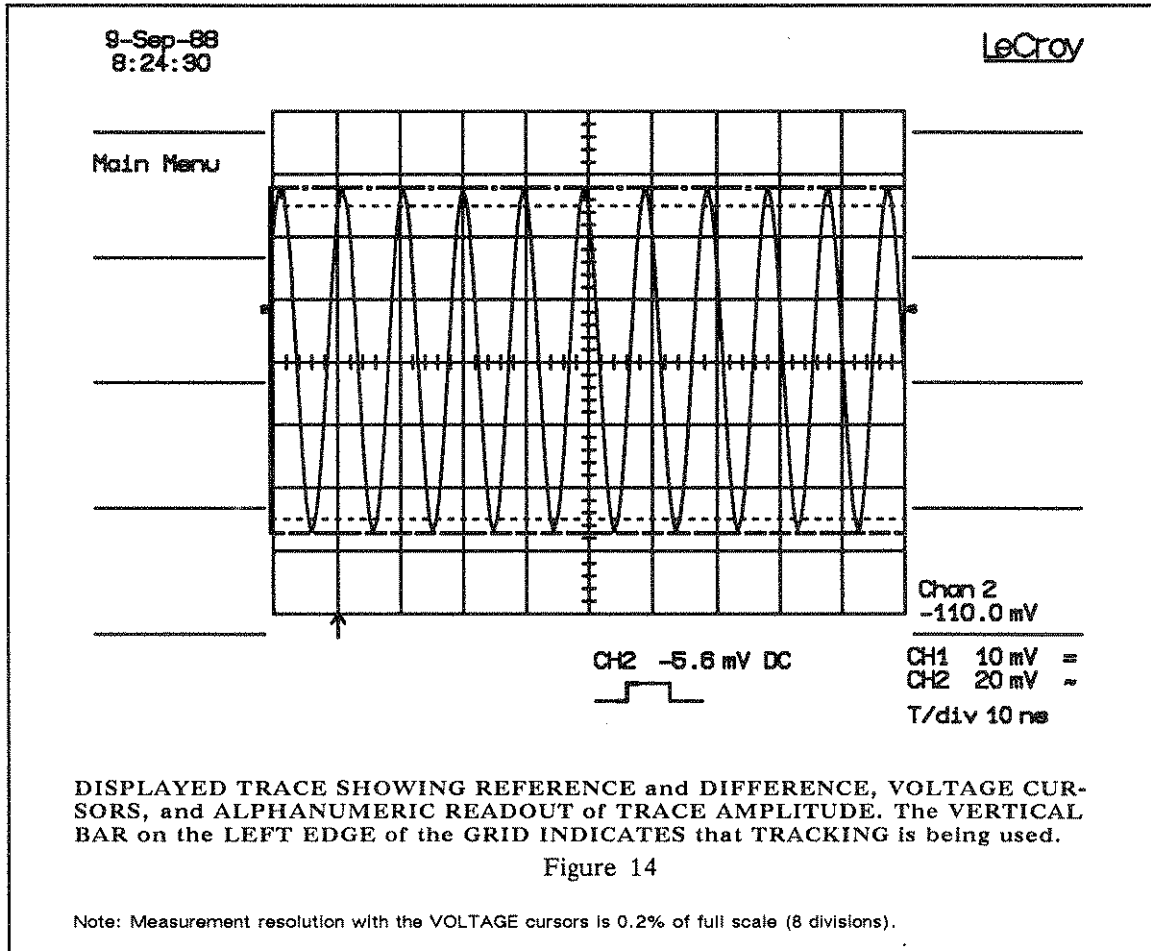

Timing Measurements

TIME Cursor button (17)– Is used in conjunction with the **Relative/Absolute** button (18).

When **Relative** time measurement is selected, a downward-pointing and an upward-pointing arrow appear on the currently displayed traces, enabling accurate differential time, voltage and frequency measurements. The timing arrows may be repositioned using the **Reference** control knob (42) for the downward-pointing arrow, and the **Difference** control knob (42) for the upward-pointing arrow.

Pressing the **Tracking** button (42) causes the difference cursor to track the reference cursor at a fixed interval as determined by the

Difference control. A horizontal bar on the top line of the grid indicates that tracking is on. Its length indicates the tracking interval.

Time cursors are displayed in Figure 15.

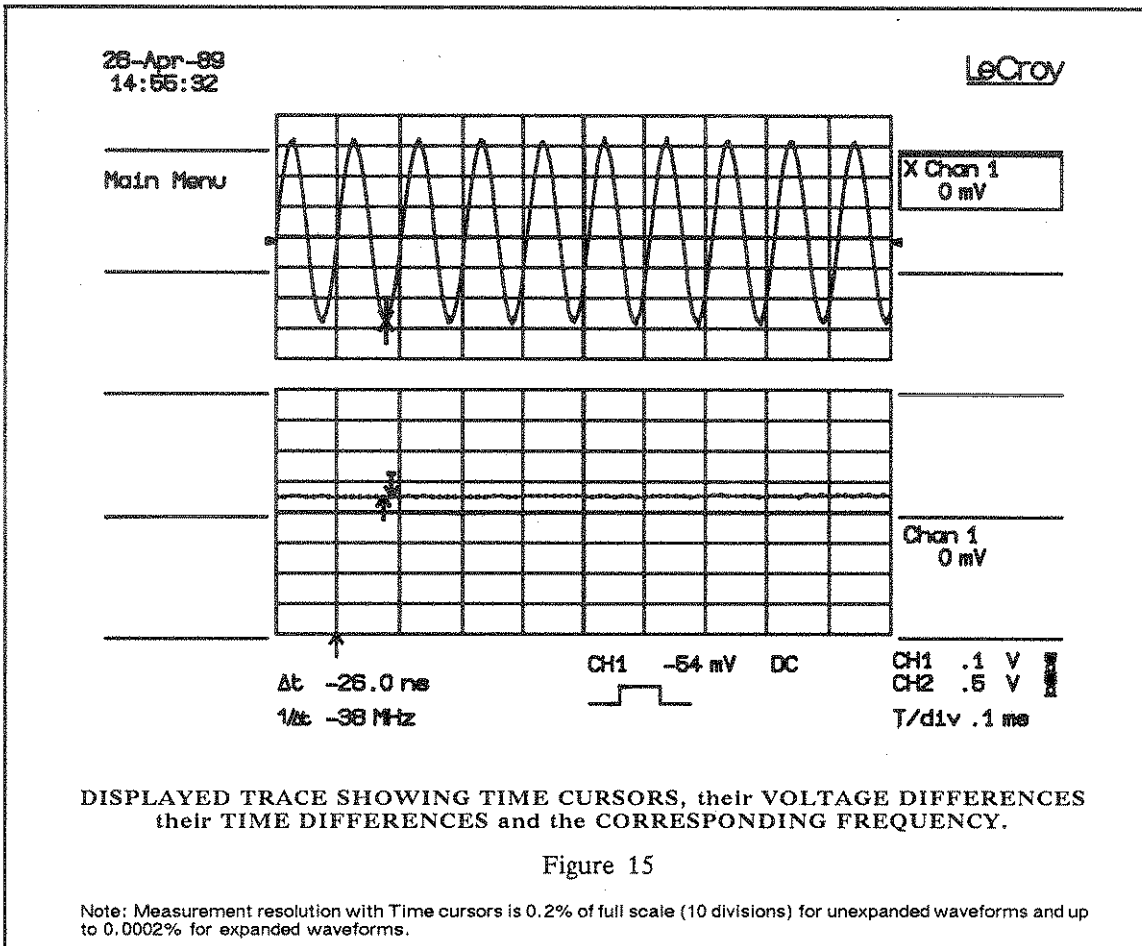

However, for expanded traces, time cursors may be positioned on the waveforms that have been magnified up to 1000 times. Higher resolution measurements, up to $\approx 10\%$ of the data point sampling interval, are therefore possible depending on the setting of the Time Magnifier control (47).

It is recommended that the waveform expansion facility be used whenever high-accuracy time measurements are required.

When **Absolute** time measurement is selected, a cross-hair marker (+) is generated. The marker provides precise time measurements relative to the point of triggering, as well as absolute voltage measurements along the displayed waveform (irrespective of the vertical offset of the trace displayed on the grid). The cross-hair marker is positioned on the traces with the **Reference** control knob (42).

When the time-base setting implies that less than 500 digitized points fill the screen, the 9450 interpolates using straight line segments between actual data points. If 200 points or less are used, the digitized points are clearly visible as intensified points on the screen. When a cursor is placed on an actual data point, small horizontal bars appear on the cursor as shown in Figure 16.

Note that setting the cross-hair marker to 0 time interval provides a visual indication of the trigger point. The cross-hair marker is displayed as follows:

6 Manual Operation

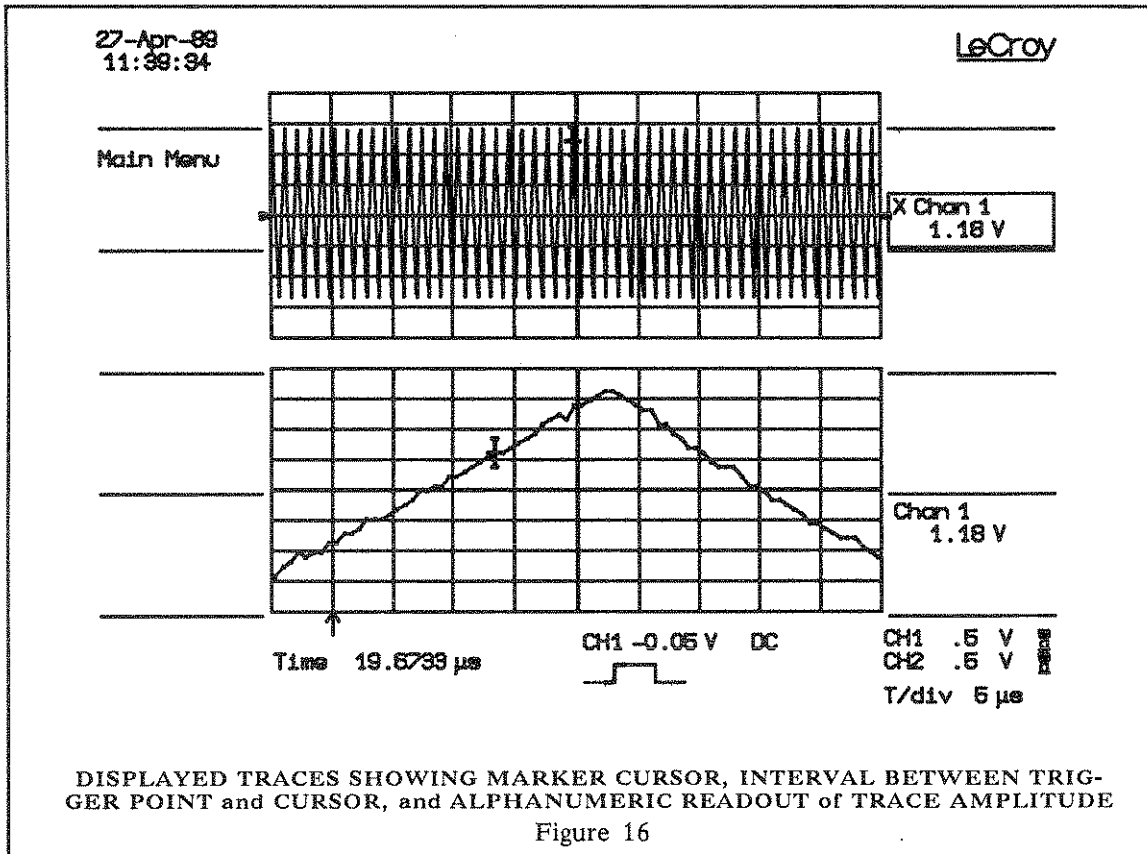

PULSE PARAMETERS

Pressing the **Parameters** button (15) activates a special display on the the oscilloscope (Figure 17) which is used to show pulse parameters. The mode allows up to ten waveform parameters to be calculated automatically on any trace. Parameters may be determined on live, stored or processed waveforms. Pulse parameters cannot be calculated on waveforms acquired in sequence mode. In this case, individual segments may be viewed using the expansion capability and pulse parameters calculated on the expanded segment.

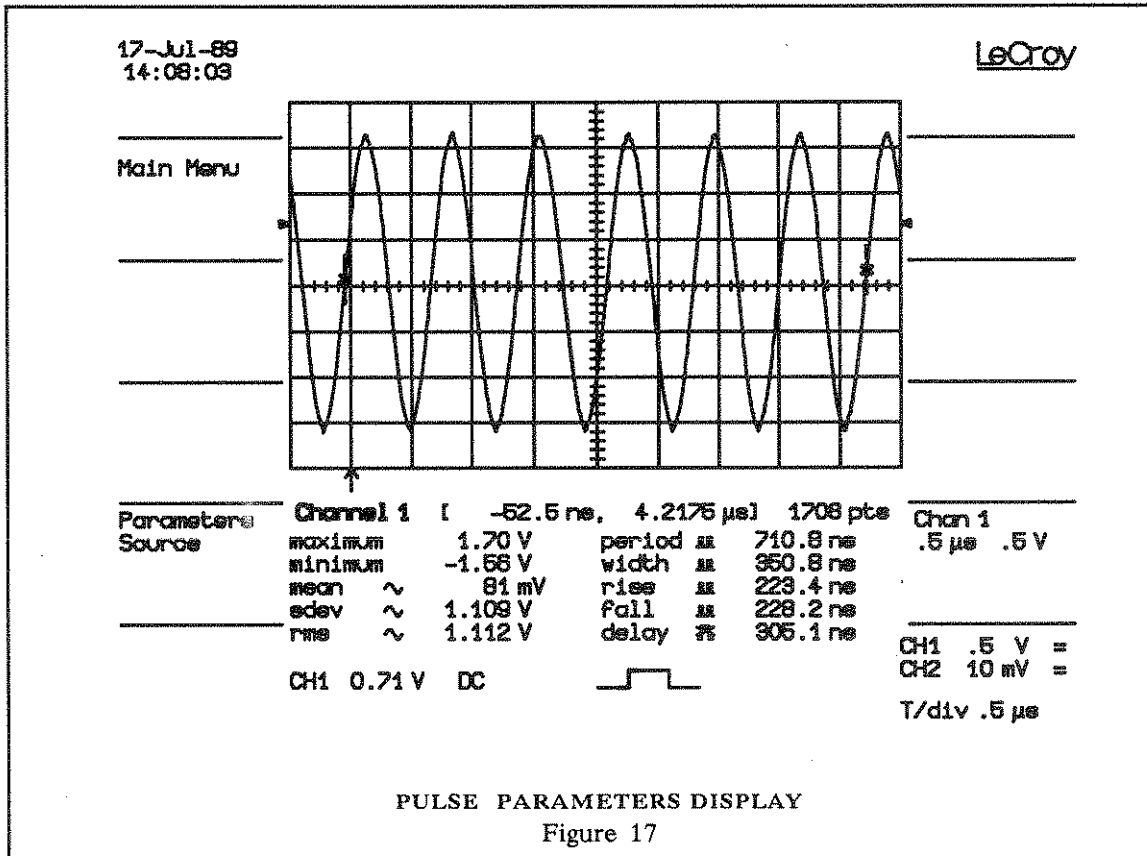

Traces are selected using the **Parameters Source** button (8) in the Menu field (II) of the root menu. Pressing the **Parameters Source** button several times allows the user to scroll through the currently displayed waveforms. The selected trace is indicated in the first line of the text under the grid and also by a pair of cross-hair cursors which ride on the trace. Parameter measurements are based on the recommendations of IEEE Std 181-1977 "Standard on Pulse Measurement and Analysis by Objective Techniques", and terminology is derived from ANSI/IEEE Std 194-1977 "Standard Pulse Terms and Definitions". See Figure 18.

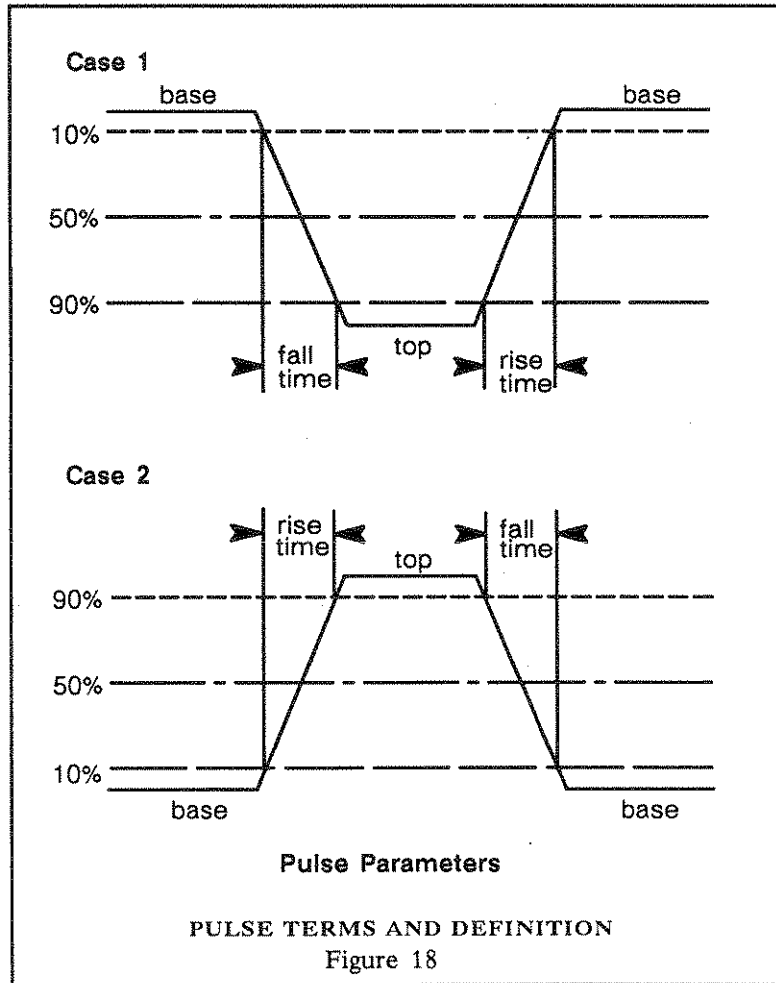

Once the **Parameters** button has been pressed, a pair of cross-hair cursors automatically appear on the currently selected waveform. Measurements may be performed on any region of interest, by simply positioning the cursors using the **Reference** and **Difference** controls (42). The cursors define the left and right hand boundaries of the area in which measurements will be made.

Pressing the **Tracking** button (47) causes the difference cursor to track the reference cursor at a fixed interval as determined by the **Difference** control. A horizontal bar on the top line of the grid

indicates that tracking is on. Its length indicates the tracking interval.

Precise information relating to the cursor positions (in time), and the number of data points within the region of interest, is provided in the first line of the text below the grid. Cursor movement is stopped at the left and right edges of the grid.

To exit the Pulse Parameters display, simply press the **Parameters** button (15) or any **Cursor Measurement** button (16) and (17).

The Waveform Parameters

The waveform parameters automatically calculated on a region of interest may be divided into two classes:

Voltage Measurements	Time Measurements
Maximum	Period
Minimum	Width
Mean	Risetime
Standard Deviation	Falltime
RMS	Delay

Voltage Measurements

In order to find magnitude reference crossings, the base and top magnitudes are assigned. The method employed follows IEEE Std 181-1977. The magnitude histogram of the waveform within the cursor window is created and searched for dominant magnitude populations. If no two dominant populations can be found, the minimum and the maximum of the distribution are used. Of the two magnitudes the lowest in the cursor window is assigned to the base line and the highest to the top line.

Maximum determines the maximum voltage within the area defined by the cursors.

Minimum determines the minimum voltage within the area defined by the cursors.

Note: In the following, v_i denotes the measured sample values. The number of data values used for computing Mean, Standard Deviation and RMS values depends on the identification of a periodic waveform. If one or more periods could be identified, a sub-window is used which starts at the first mesial point (50% magnitude transition) and ends at the last mesial point on a leading edge in the original window (i.e. in the formulae below, N = the number of data points within the periods found up to a maximum of 100 periods). In all other cases, Mean, Standard Deviation and RMS are evaluated using all data points inside the cursor window.

6 Manual Operation

Mean determines the average value of all the data points selected as described above.

$$\frac{1}{N} \sum_{i=1}^N v_i$$

Standard Deviation (Sdev) is the standard deviation of the measured points from the mean. It is calculated from the following formula:

$$\sqrt{\frac{1}{N-1} \sum_{i=1}^N (v_i - \text{mean})^2}$$

RMS is derived from the square root of the average of the squares of the magnitudes, for all the data as described above.

$$\sqrt{\frac{1}{N} \sum_{i=1}^N (v_i)^2}$$

Time Measurements

Note: For the time measurements it is necessary to distinguish between magnitude crossings occurring on leading edges and those occurring on trailing edges. In the equations below, the following notation has been used:

$M\uparrow$ = number of leading edges found

$M\downarrow$ = number of trailing edges found

t_i^x = time when leading edge i crosses the $x\%$ level

t_i^x = time when trailing edge i crosses the $x\%$ level

All times are linearly interpolated between two measured points.

Period is calculated from the average length of the full periods of the waveform within the selected interval. A full period is the time measured between the first and third 50% crossing points, the third and fifth, the fifth and seventh, etc.

$$\frac{1}{M\uparrow - 1} \sum_{i=1}^{M\uparrow - 1} (t_{i+1}^{50} - t_i^{50})$$

Pulse Width (Width) determines the duration between the **Pulse Start** (mesial point, i.e. the 50% magnitude transition point, on the leading edge) and the **pulse stop** (mesial point on the trailing edge) of a pulse waveform. Like the **Pulse Start** the pulse stop is a 50% magnitude reference point.

$$\frac{1}{M_{\downarrow}} \sum_{i=1}^{M_{\downarrow}} (t_{\downarrow i}^{50} - t_{\uparrow i}^{50})$$

Risetime (Rise) measures the time of a pulse waveform's transition with a positive slope.

Falltime (Fall) measures the time of a pulse waveform's transition with a negative slope.

For both risetime and falltime measurements the instrument determines the duration between the proximal point (10% magnitude transition) and the distal point (90% magnitude transition) on leading edges and the duration between the distal point and the proximal point on trailing edges:

leading edge duration =

$$\frac{1}{M_{\uparrow}} \sum_{i=1}^{M_{\uparrow}} (t_{\uparrow i}^{90} - t_{\uparrow i}^{10})$$

trailing edge duration =

$$\frac{1}{M_{\downarrow}} \sum_{i=1}^{M_{\downarrow}} (t_{\downarrow i}^{10} - t_{\downarrow i}^{90})$$

Depending on the sign of the slope of the leading edge transition, the instrument then assigns either:

for positive slope: Risetime = leading edge duration

Falltime = trailing edge duration

for negative slope: Risetime = trailing edge duration

Falltime = leading edge duration

Delay is the time from the trigger point to the first 50% transition crossing, i.e. the **Pulse Start**.

$$t_{\uparrow i}^{50}$$

Information and Warning Symbols

If the number of points used is small, the statistical uncertainties in determining the base and top levels may be high and hence overall accuracy may be reduced.

The algorithm which determines the pulse waveform parameters is capable of detecting certain situations where the mathematical formulae may be applied but the results obtained must be interpreted with caution. In these cases the name of the parameter and its value are separated on the screen of the 9420/50 by a graphic symbol. The symbols and their meanings are indicated in Figure 19.









INFORMATION	
	Parameter has been determined for several periods (up to 100) and the average of those values has been taken.
	Parameter has been determined over an integral number of periods.
	Insufficient data to determine a parameter.
WARNINGS	
	Waveform cannot be classified as "pulse waveform", i.e. amplitude histogram is flat within statistical fluctuations. Minimum and maximum are used to assign base and top.
	Only an upper limit could be estimated (actual value of parameter may be smaller than displayed value).
	Signal is partially in overflow.
	Signal is partially in underflow.
	Signal is partially in overflow and partially in underflow.
PULSE PARAMETER WARNINGS	

Figure 19

**REMOTE CONTROL
AND INTERRUPTION**

When the oscilloscope is being remotely controlled, LED (19) lights up. To return to local control, the user can press **Local**, button (20), if the instrument is not in the remote state with the lockout state selected. Full details of remote control, as well as a list of the commands, are given in the Remote Control manual.

AUTOMATIC SETUP

Pressing the **Auto Setup** button (21) automatically scales the time-base, trigger and sensitivity settings to provide a stable display of *repetitive* input signals. Signals detected must have an amplitude between 2 mV and 8 V, a frequency above 50 Hz and a duty cycle greater than 0.1%. The time taken for the auto-setup operation to be completed depends on the signal frequency, and is about 2 sec. Auto-setup operates as follows:

- * Auto-setup changes neither the input coupling nor the bandwidth limit setting.
- * Auto-setup operates only on channels whose traces are currently turned on. The only exception occurs when no trace at all is turned on. In that case auto-setup operates on all channels and turns all of the traces on.
- * If signals are detected on several channels, the lowest numbered channel with a signal determines the selection of the time base and trigger source.
- * If a pure DC signal is found, the trigger mode will be set to **AUTO** and the time base to 10 μ sec.
- * Where the trace can not be shown entirely, or cannot be centered, auto-setup will indicate the cause of the problem:
 - Signal amplitude too large
 - DC component too large to show signal
 - DC component too large to center signal

**MENU FIELD (II)
CONTROLS**

After the **Main Menu** button (2) has been pressed, any one of the oscilloscope's interactive menus may be selected by pressing buttons (2) through (10). Figure 20 shows the available menus which appear next to the adjacent menu keys. To obtain a given menu, simply press the button adjacent to the required menu.

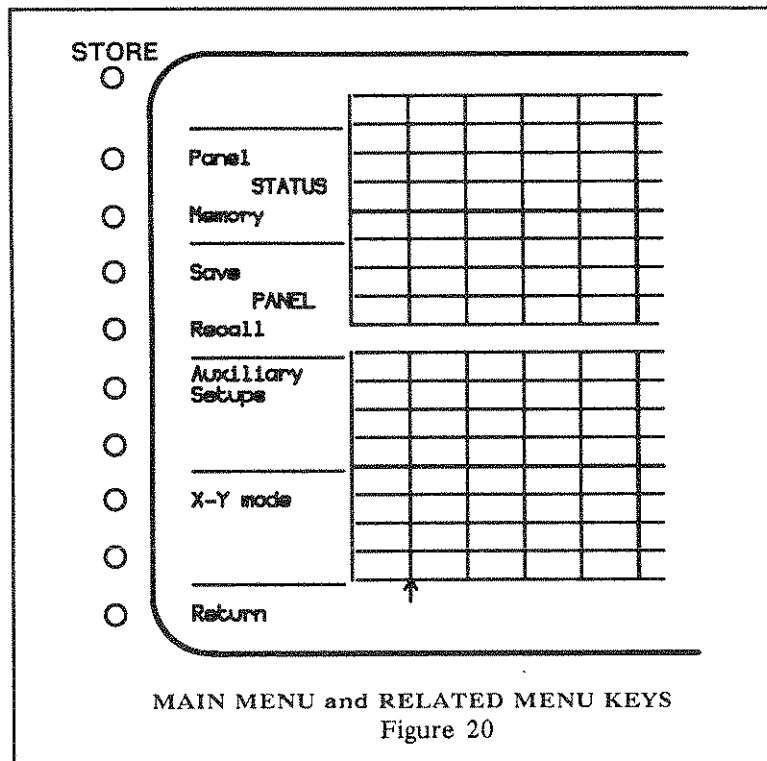

PANEL STATUS MENU

The **Panel Status** menu (Figure 21) provides the user with a complete report of the front-panel settings and enables on-screen adjustment of acquisition parameters.

Modify SMART Trigger button (2) displays the SMART trigger menu which allows the user to adjust the SMART trigger as required. Further details are given in Section 7.

Channel 1 Attenuator (4) and **Channel 2 Attenuator** (5) allow the user to enter probe attenuation factors of 1, 10, 100, 1000 or 10000.

Segments Modify button (6) allows the user to set the number of segments for a sequence acquisition to 2, 5, 10, 20, 50, 100 or 200.

Special Modes button (8) allows the user to access the menu for the **External Time-base Control** and the **Continuous Sequence Mode**.

Press the **Return** key (10) to return to the main menu.

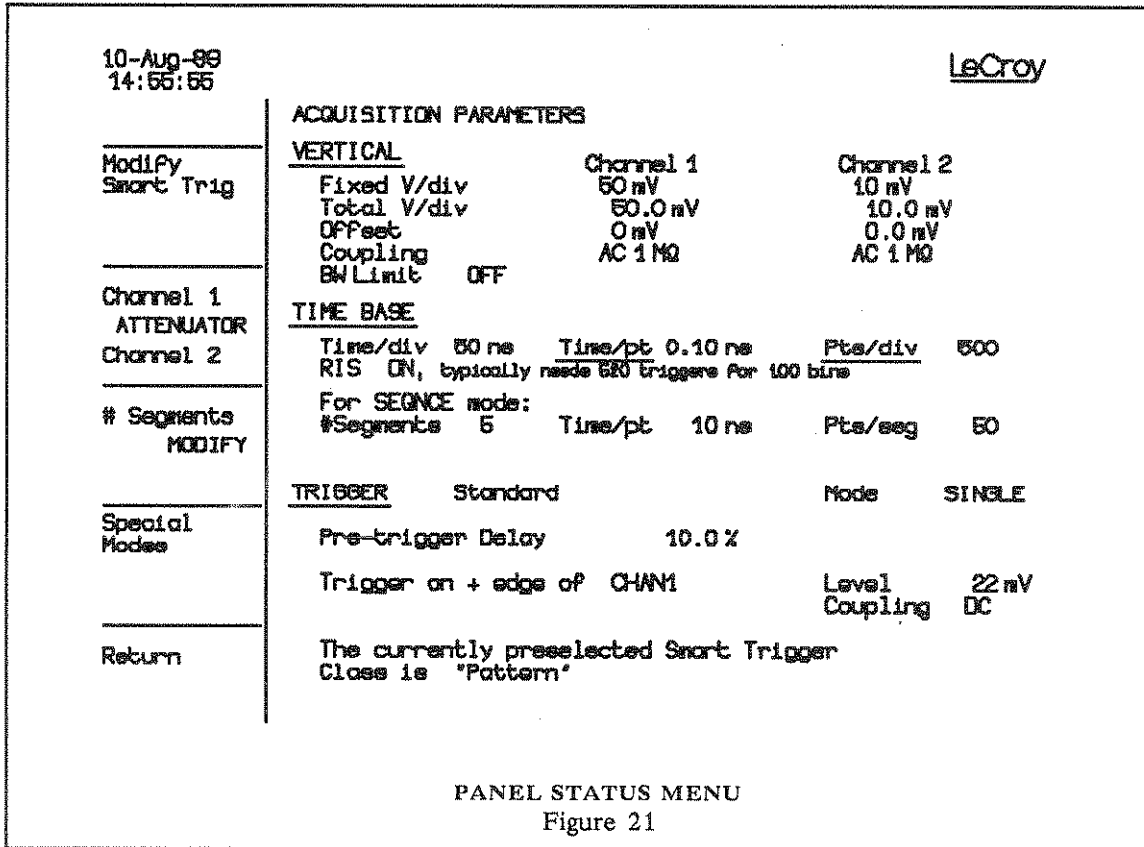

The following information is presented on the screen:

Vertical Parameters

Fixed V/Div indicates the current setting of the front-panel control (29) with the VAR vernier in the fully clockwise position.

Total V/Div indicates the current setting of the front-panel Volts/Div control (29) plus the additional sensitivity range (up to $\times 2.5$ of the Fixed V/Div setting) provided by turning the VAR vernier (30) counterclockwise.

Time-base Parameters

Time/Point indicates the time between digitized points for the corresponding time-base setting.

Points/Div indicates the number of digitized points per division on the display of any non-expanded waveform.

Segments indicates the number of segments selected for sequential acquisition. On-screen modification of this parameter is possible by pressing the **Modify # Segments** button (6) to change the indicated segment number from 2 to 200 in a rolling sequence.

If the time-base setting is 5, 2 or 1 nsec/div, a message will be displayed indicating that the time base is too fast for the sequence mode.

Trigger Parameters

Trigger Delay is indicated as being either a pretrigger or post-trigger delay. In Figure 21 the pretrigger delay indicated is 10%, meaning that when in main menu the delay arrow is positioned one division to the right of the left-hand edge of the grid. In the case of a post-trigger delay setting, this would be indicated in decimal fractions of a second (e.g., ← 4.00 msec).

Level- Indicates the trigger level in volts.

SMART Trigger Mode

The currently selected SMART trigger mode (single source, pattern, state qualified, time/events qualified, or TV) is always displayed in the Panel Status menu. When the SMART trigger is switched on, this will be the configuration.

MEMORY STATUS MENU The Panel Status menu displays acquisition parameters for waveforms to be acquired. The Memory Status menu on the other hand displays acquisition parameters for waveforms already acquired and currently stored in the various memories of the 9420/50.

The annotation used for Memory Status is similar to that of the Panel Status menu. Pressing the Memory Status button (3) displays the Memory Status menu for Channel 1 as shown in Figure 22.

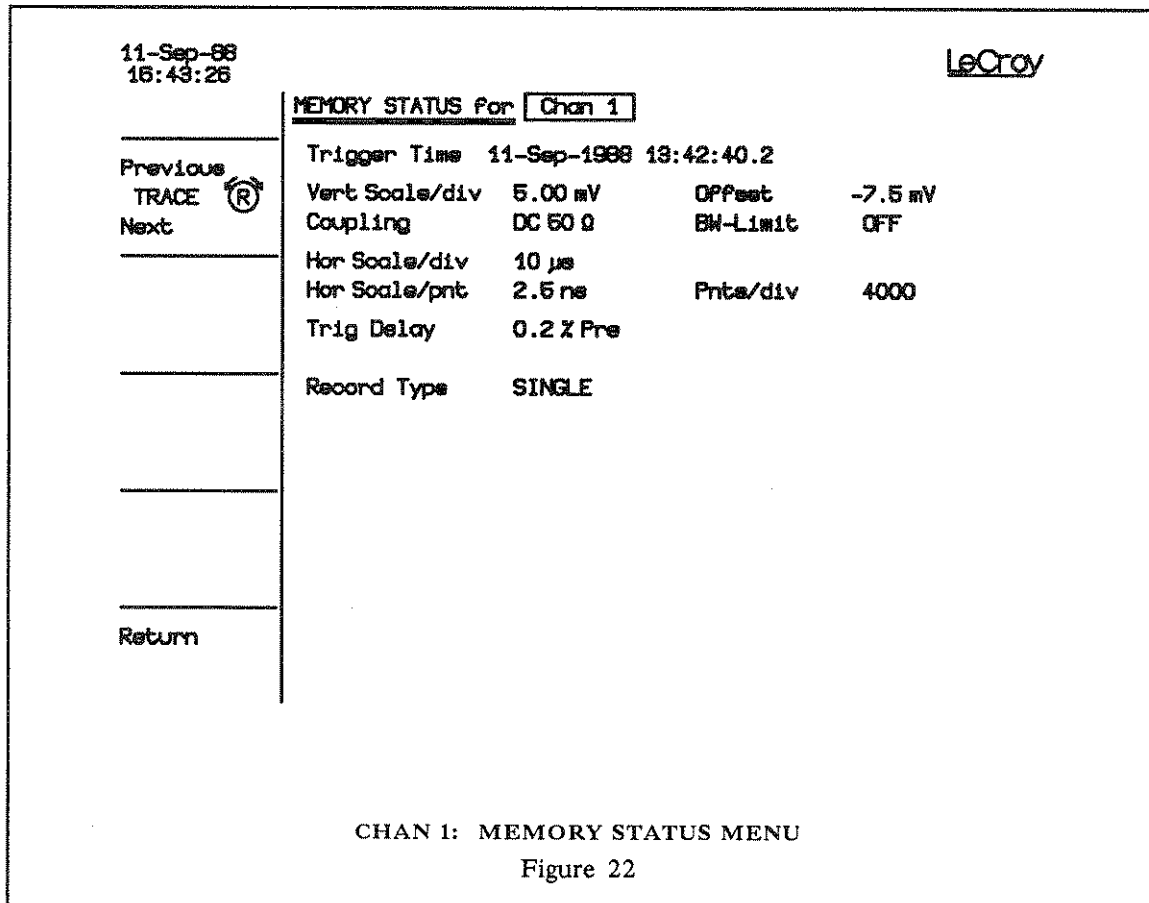

Pressing button (2) or (3) or rotating the Reference button (42) while in the Memory Status menu will display in turn the acquisition parameters of all the waveforms stored in acquisition, expansion, storage and function memories respectively (see Figures 22 through 25).

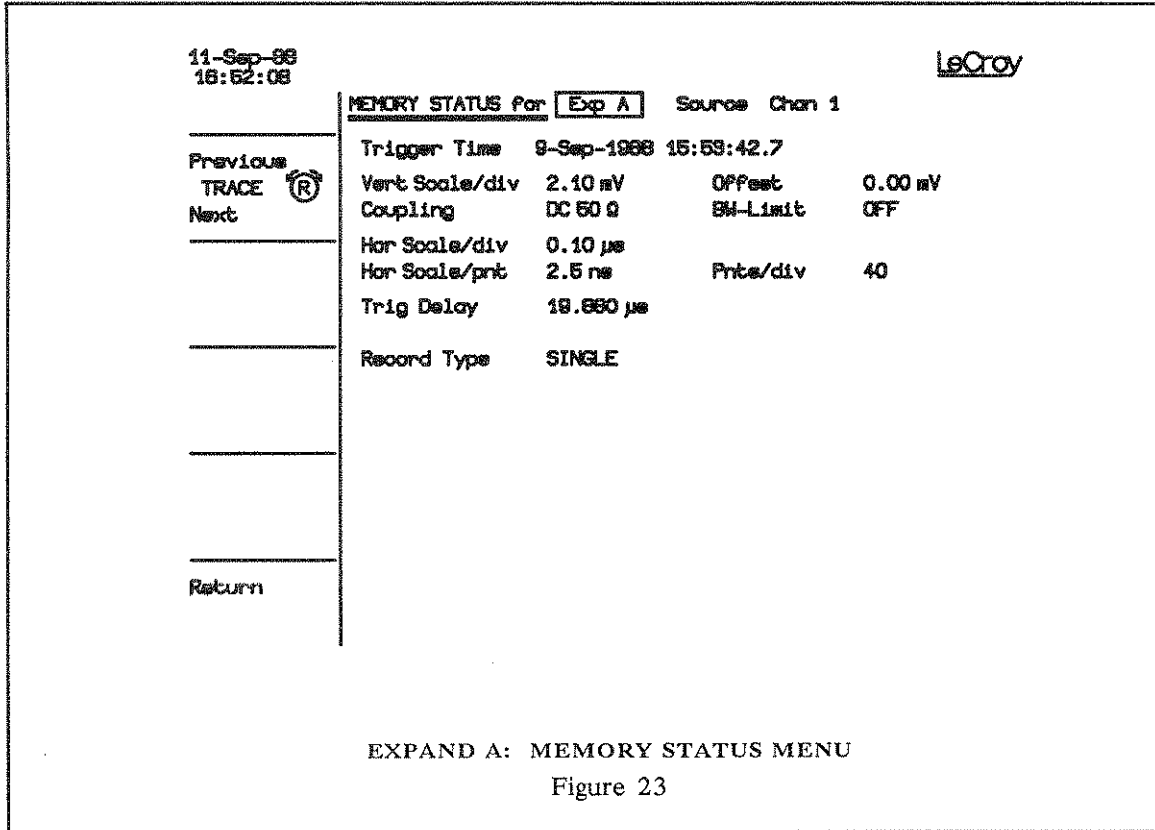

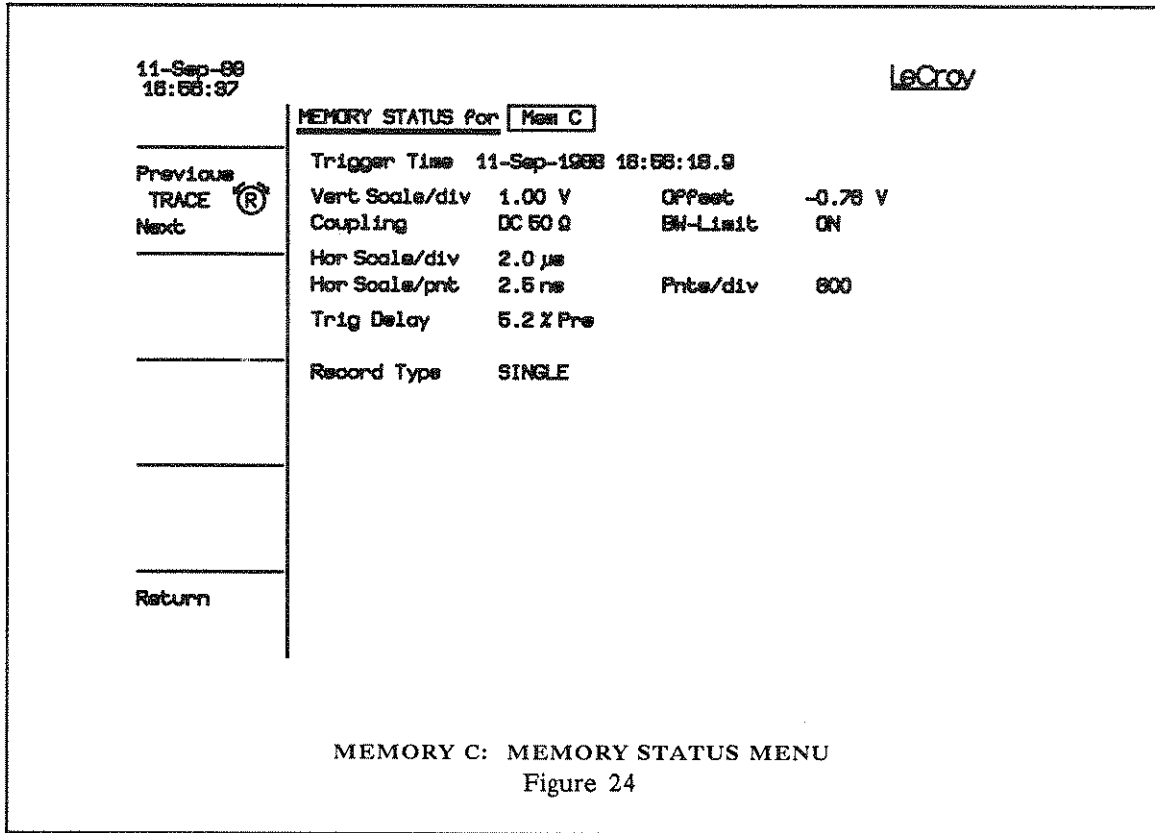

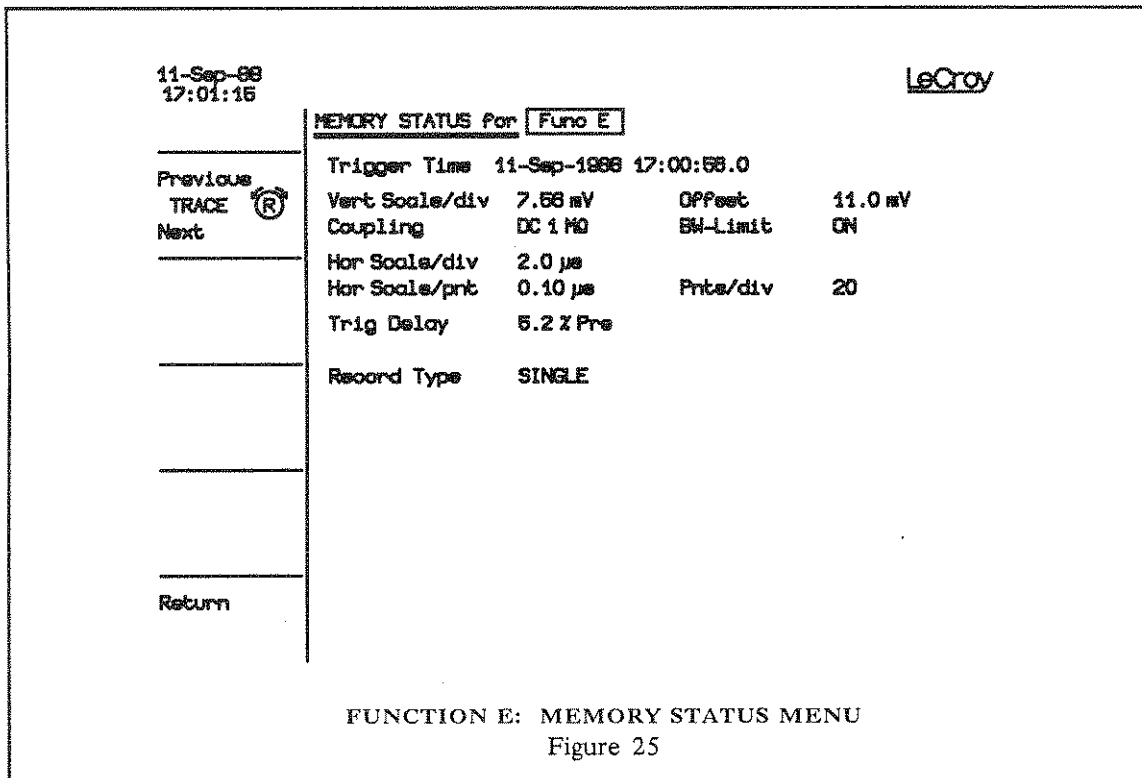

Trigger Time Stamps

A clock provides trigger time stamps for each acquisition. For single-shot applications, the trigger time is available in the Memory Status menu as shown in Figure 22. When a series of waveforms has been acquired in sequence mode, a special feature is available in the Memory Status menu as shown in Figure 26. By pressing the **Sequence Times** button (5) it is possible to obtain further information about the trigger timing (Figure 27). The sequence times of an acquisition can be displayed while the data are being acquired.

LeCroy

13-Sep-68
16:37:59

MEMORY STATUS for Chan 1

Previous	Trigger from 13-Sep-1968 16:32:28.8 for 29.898 s			
TRACE (R)	Vert Scale/div	100 mV	Offset	-12 mV
Next	Coupling	DC 50 Ω	BN-Limit	OFF
	Hor Scale/div	0.20 μs		
	Hor Scale/prt	2.5 ns	Pnts/div	80
Sequence	Trig Delay	28.0 % Pre		
Times	Record Type	SEQUENCE	#Sweeps	10
Return				

MEMORY STATUS MENU after an ACQUISITION in SEQUENCE MODE
Figure 26

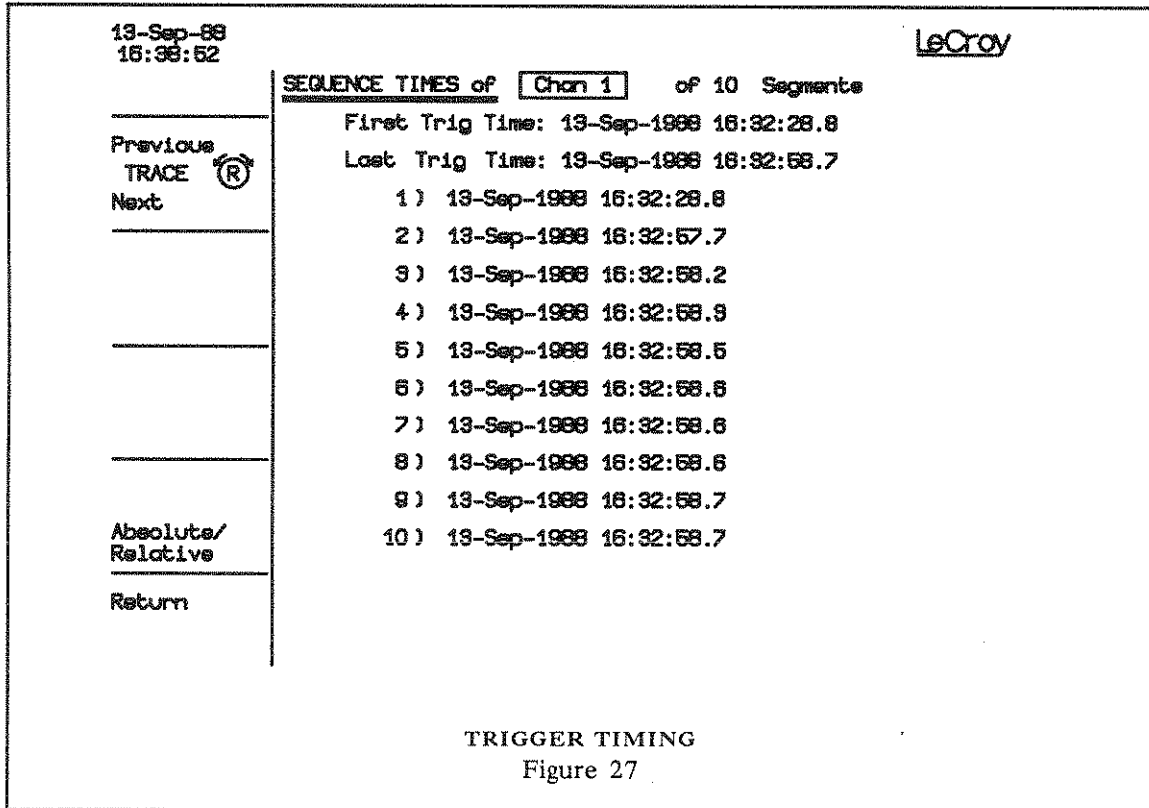

Buttons (1) and (2) select the required trace, Chan 1, Chan 2, Mem C, Mem D, Fun E or Fun F.

Buttons (6) and (7) and the Difference knob (42) allow the user to scroll through the list of trigger times.

Pressing the Absolute/Relative button (9) displays either absolute trigger times with 0.1 sec resolution together with dates, or trigger times relative to the first trigger with 1 nsec resolution.

The sequence times of a continuous sequence mode acquisition are only available after the acquisition has been terminated.

SAVING AND RECALL OF FRONT-PANEL SETUPS

Pressing the Save Panel or Recall Panel buttons ((4) and (5) respectively) in the Main menu enables the user to store or recall up to seven different front-panel acquisition parameter settings.

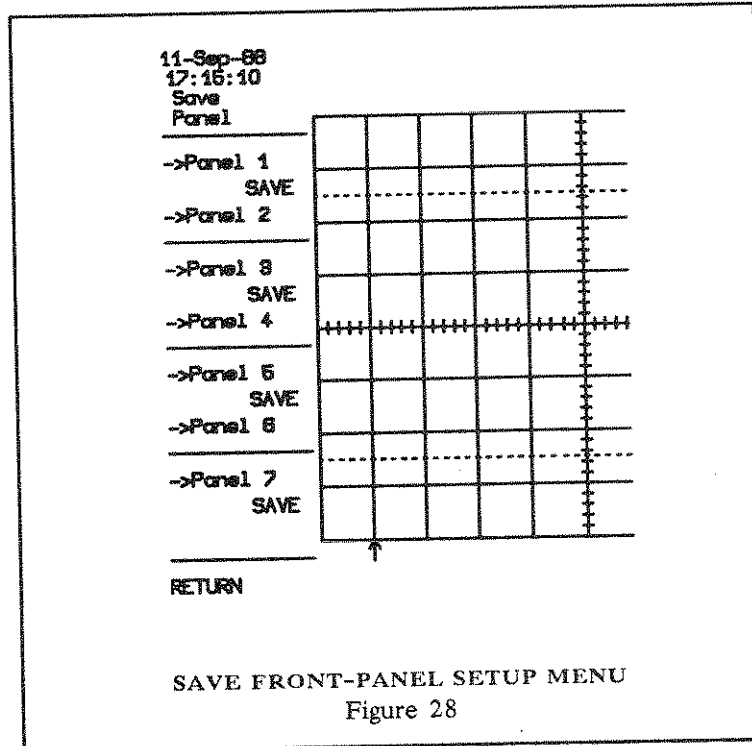

Once you have obtained a satisfactory front-panel setup, simply call the **Save Panel** menu (Figure 28) by pressing button (4); then press any one of the buttons (2) through (8) to store this front-panel setup where required. Press the **Return** button (10) to go back to the Main menu and continue normal oscilloscope operation.

To recall a previously stored front-panel setup, press the **Recall Panel** button (5) while in the Main menu. A list of the seven stored front-panel setups which are available will be displayed (Figure 29). Previously stored settings will be indicated together with the date and time at which they were stored. Press the button ((2) through (8)) which corresponds to the required setup, and the front-panel settings will automatically be configured according to the acquisition parameters recalled.

6 Manual Operation

11-Sep-88 17:21:09		LeCroy
	<u>RECALL PANEL</u>	
Panel 1	From 8-Sep-1988 17:30:31	
RECALL		
Panel 2	From 8-Sep-1988 17:30:48	
Panel 3	From 11-Sep-1988 17:19:53	
RECALL		
Panel 4	From 11-Sep-1988 17:20:16	
Panel 5	From 11-Sep-1988 17:19:57	
RECALL		
Panel 6	Empty	
Panel 7	Empty	
RECALL		
Default	A predefined reproducible state	
RETURN		

RECALL FRONT-PANEL SETUP
Figure 29

The default setup menu, button (9), is shown in Figure 30.

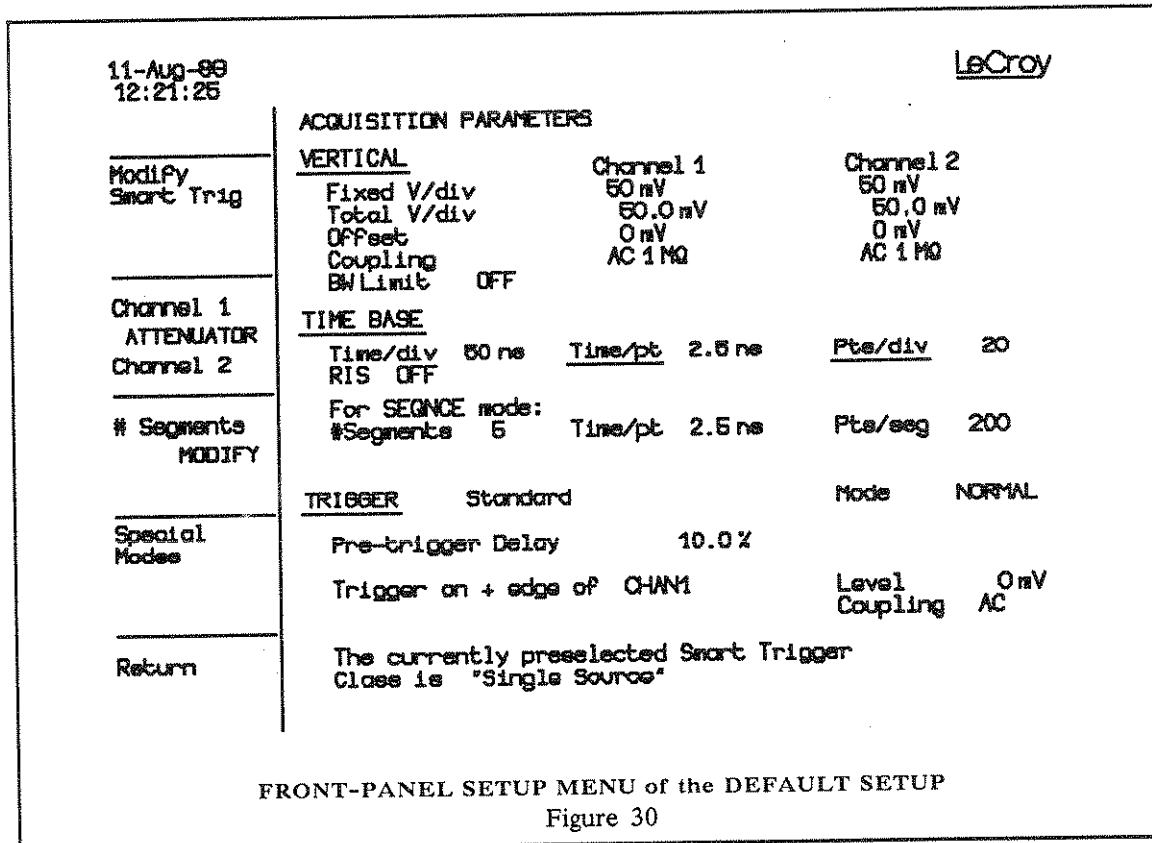

AUXILIARY SETUPS

To access the auxiliary setups menu, (Figure 31 for the 9420 and Figure 32 for the 9450), press button (6) in the Main menu. Information on the following is supplied for your 9420/50.

- Serial number
- Software version
- Software options
- Hardware options
- GPIB and RS-232-C configuration

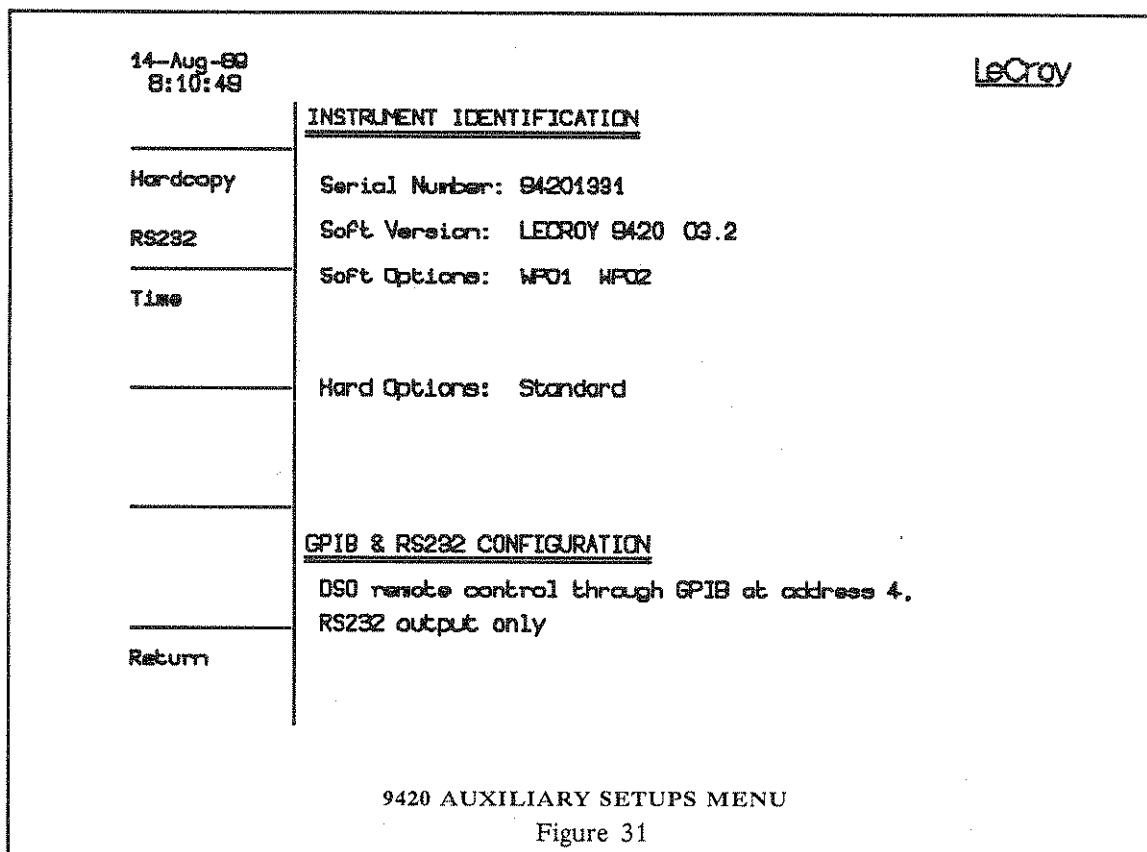

11-Aug-89 14:10:58		LeCroy
	<u>INSTRUMENT IDENTIFICATION</u>	
Hardcopy	Serial Number: 94501729	
RS232	Soft Version: LECROY 9450 03.2	
Time	Soft Options: Standard	
	Hard Options: Standard	
	<u>GPIB & RS232 CONFIGURATION</u>	
	DSO remote control through GPIB at address 4, RS232 output only	
Return		

9450 AUXILIARY SETUPS MENU
Figure 32

Hard Copy

The 9420/50 has been designed to enable direct interfacing of the oscilloscope via the rear-panel GPIB (IEEE-488) or RS-232-C plotter port. Single or multi-pen digital plotters, as well as HP, IBM and EPSON printers can be used to make hard copies of the display.

When the 9420/50 is connected to a plotter via the GPIB port, with no host computer in the configuration, the oscilloscope's rear panel thumb-wheel switch must be set to the Talk Only mode (address ≥ 31 decimal) and the plotter to the Listen Only mode.

Note: Whenever the GPIB address is changed, the power must be turned off and on again.

Enter the **Hardcopy** menu (Figure 33) by pressing button (2) in the **Auxiliary Setups** menu.

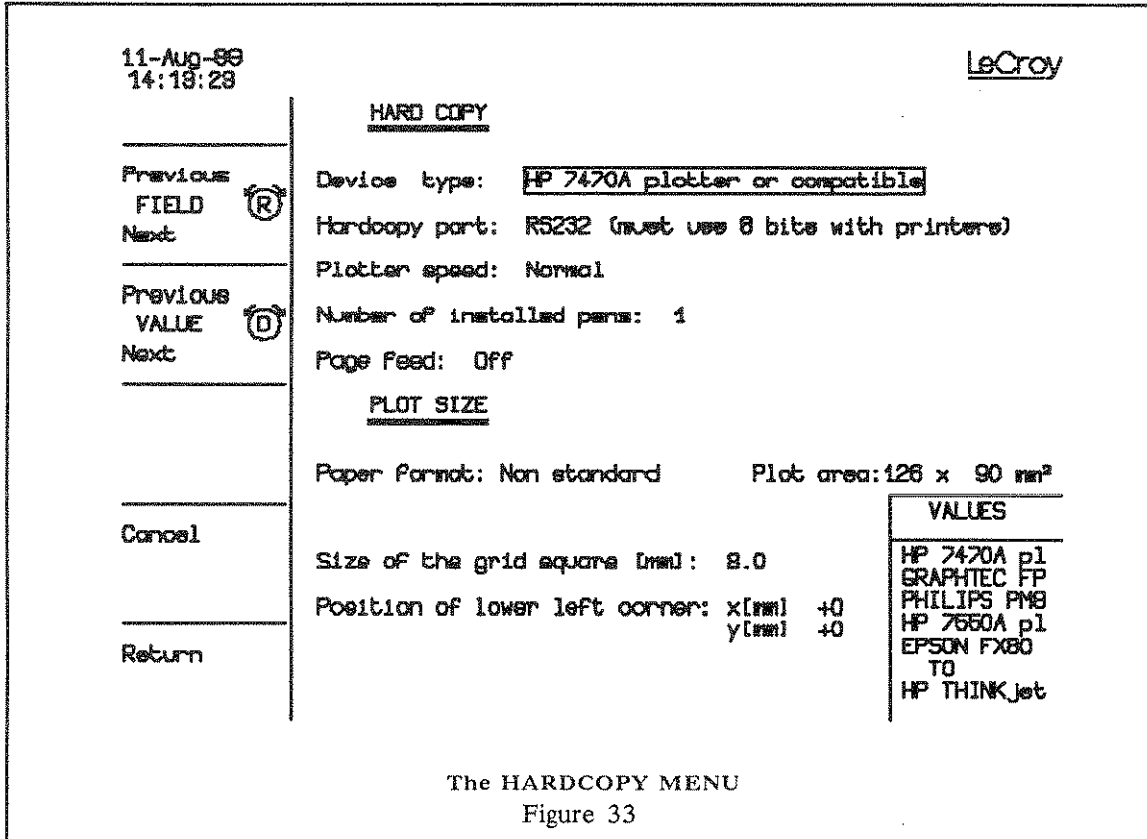

Use the Reference knob (42) or buttons (2) and (3) to scroll through the parameters. Note that the options available for each parameter are indicated in the lower right hand edge of the screen. Use the Difference knob (42) or buttons (4) and (5) to choose the required option.

Hardcopy parameters can be selected by the user as shown in the following table:

PLOTTERS		PRINTERS	
Device Type:	HP7550A (or compatible) HP 7470A (or compatible) Graphtec FP 5301 Philips PM8151	EPSON FX80 (or compatible) HP QuietJet (or compatible) HP ThinkJet HP LaserJet	
Hardcopy Port:	RS-232-C GPIB (IEEE-488)	RS-232-C	
Graphics Density:	-----	Two to one Single Double Hi-speed double Quadruple CRT screen One to one Hi-res CRT	
Plotter Speed:	Normal Low speed	-----	
Number of Installed Pens:	1 to 8	-----	
Page Feed:	Off On	Off On	
Plot Size:	ISO A5-US 8.5"x5.5" Plot Area: 157x112 mm ² ISO A4-US 8.5"x5.5" 235x168 mm ² ISO A3-US 17"x11" 313x224 mm ² Non-standard	Size of grid square [mm]: 1 to 99.9 mm in steps of 0.1 mm	
Non-standard:	Size of the grid square: 1 to 99.9 mm in 0.1 mm steps Lower left corner position x [mm]: -999 to 999 mm in 1 mm steps y [mm]: -999 to 999 mm in 1 mm steps		

Table 4

When the Hardcopy menu has been set up as required, pressing the **Screen Dump** button (11) will result in a copy of the current screen being made on the plotter or printer. Note that plots are produced in parallel with normal oscilloscope operation. It is therefore possible to record and process waveforms while hard copies are being made. However, screen dumps onto a printer will halt other oscilloscope operations.

6 Manual Operation

RS-232-C Setup

An RS-232-C port is available on the rear panel of the 9420/50 enabling remote oscilloscope operation and data transfer, as well as convenient plotter interfacing.

When in the Auxiliary Setups menu, **RS232**, button (3), calls an interactive menu (Figure 34) which enables configuration of the oscilloscope's RS-232-C port for a particular application.

11-Sep-88
17:41:14

LeCroy

RS232 - Remote Control Port

Previous FIELD (R) Baud rate : 9600
Next Characters length (bits) : 8

Previous VALUE (D) Parity : none
Next Number of stop bits : 1

Cancel

Return

VALUES
110
150
200
300
600
TO
19200

RS-232-C SETUP MENU
Figure 34

To modify any of the parameters displayed, first select the field to be modified. The rectangular frame around parameter values indicates the currently selected field. Pressing the **Previous Field** button (2) will cause the frame to move towards the top of the list, whereas pressing the **Next Field** button (3) will cause the frame to move downwards. The field can also be chosen by rotating the **Reference knob** (42)

When a field has been selected, the current value of the field may be modified by pressing either the **Previous** or **Next Value** button

((4) or (5) respectively) or by rotating the **Reference** and **Difference** control knobs (42).

The Baud rate can be selected from a set of values in the range 110 through 19,200 baud. The possible settings of character length are 6, 7, and 8; parity, none, even or odd; and number of stop bits, 1 and 2.

Time Setup Menu

Enter the **Time** menu (Figure 35) by pressing **Time** button (4) in the **Auxiliary Setups** menu.

Six different fields (day, month, year, hours, minutes, and seconds) are accessed using buttons (2) and (3) or the **Reference** knob (42). The settings are changed using buttons (4) and (5) or the **Difference** knob (42).

When the date and time have been set as required, press **Load Time**, button (6), and then press **Return**, button (10), to return to the **Auxiliary Setups** menu.

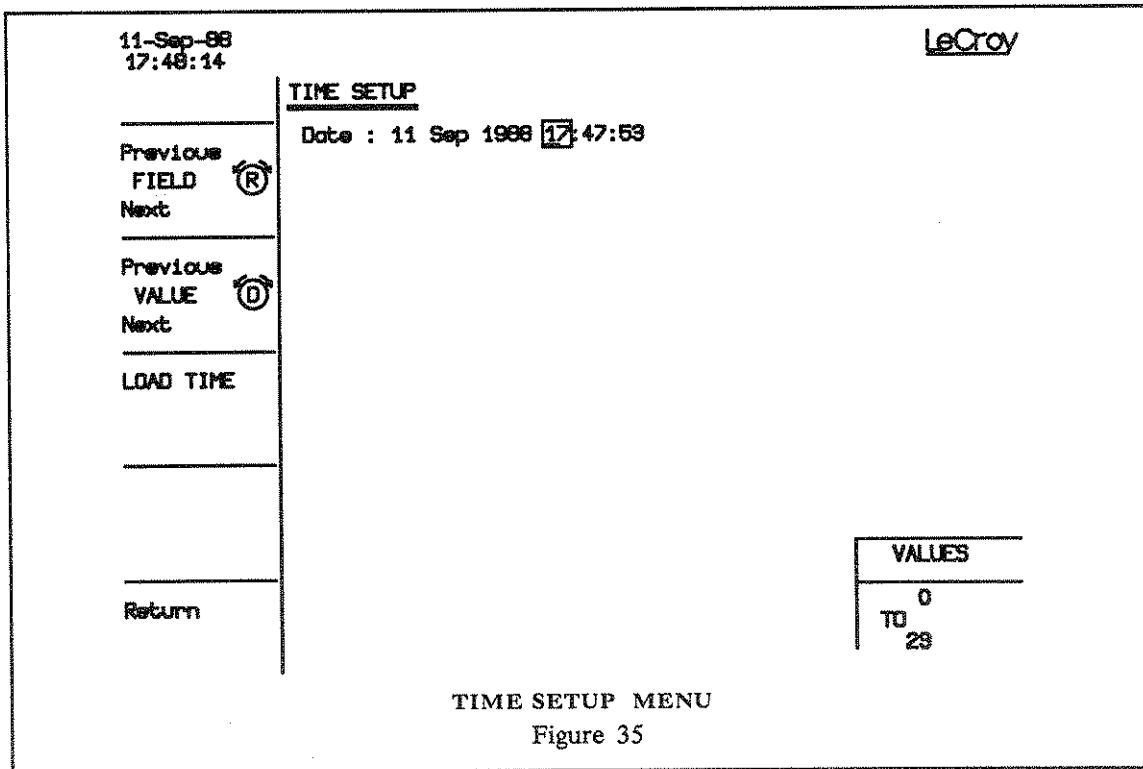

X VERSUS Y DISPLAY

The X versus Y (XY) display mode is switched on and off by pressing button (8) of the main menu. The mode allows the user to display one source (from Channel 1, Channel 2, Expand A, Expand B, Memory C, Memory D, Function E, Function F) against another. The technique is normally used to compare the amplitude information of two waveforms and can reveal phase and frequency information through the analysis of patterns called Lissajous figures.

The layout of the XY screen is shown in Figure 36. The square grid in the top half of the screen is used for the XY display while the rectangular grid underneath simultaneously shows the original source waveforms. The rectangular grid can also be used in a Dual Grid mode by pressing button (14).

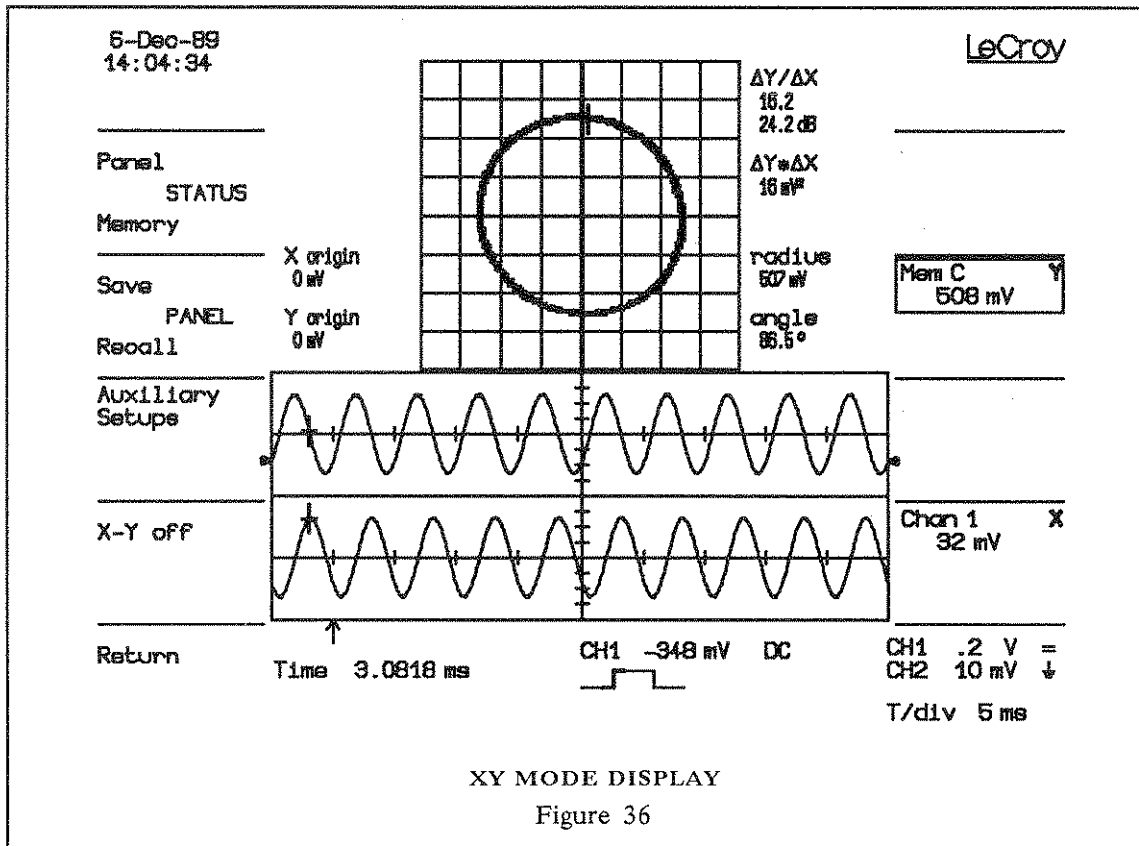

**Selecting Traces
for XY Display**

To select the two waveforms for display in the XY mode, simply use the **Trace On/Off** buttons ((50) through (53)). The first trace selected is automatically assigned to the X (horizontal) axis of the XY display. The second trace selected is assigned to the Y (vertical) axis. Both selections are indicated in the Displayed Trace field at the right-hand side.

For the XY display to be correctly generated, the traces selected must be of the same time or frequency interval/point and have the same horizontal unit (seconds or hertz). As soon as two compatible traces have been selected, the XY display is automatically generated. If incompatible traces are selected, a warning message is displayed at the top of the screen. If two compatible traces are selected that have different trigger points (horizontal offset), then only the common part of each trace is displayed.

Cursors

As with the standard waveform display, time and voltage cursors can be used with the XY display. The time cursors are similar to those of the standard waveform display, with additional cursors at the corresponding XY position in the square XY display.

Cursors move on acquired or computed traces following the associated sampling interval and on the XY display on paths given by the acquisition time (Figure 36).

The voltage cursors appear on the square grid but do not appear on the rectangular grid which shows the normal time-domain waveforms. In absolute voltage mode a vertical and a horizontal bar appear on the XY display. While in relative voltage mode a pair of vertical and a pair of horizontal bars appear on the XY display.

The X and Y absolute voltage cursors may be repositioned using the **Reference and Difference** (42) knobs and the **Cursor Control X/Y** button (9) in the Menu field (II).

The X and Y relative voltage cursors may be repositioned using the **Reference and Difference** (46) knobs and the **Cursor Control X/Y** button (9) in the Menu field (II).

The voltage value of each cursor is shown below the trace title in the fields on the right hand side of the screen. The time cursor value which is common to all traces is shown at the lower left of the screen.

Combinations of the vertical values (voltages) are shown at the right side of the square grid (see Figure 36):

- | | |
|---------------------------|---|
| (1) The ratio | $\Delta Y \text{ value} / \Delta X \text{ value}$ |
| (2) The ratio in dB units | $20 \cdot \log_{10}(\text{ratio})$ |
| (3) The product | $\Delta Y \text{ value} * \Delta X \text{ value}$ |

6 Manual Operation

- (4) The distance to the origin $r = \text{sqrt}(\Delta X^2 + \Delta Y^2)$
 (5) The angle (polar) $\theta = \text{arc tan}(\Delta Y / \Delta X)$
 range $[-180^\circ \text{ to } +180^\circ]$.

The definition of ΔX and ΔY is dependent on the type of cursors used. The following table shows how ΔX and ΔY are defined for each type of measurement.

Cursors					
	V_{Abs}	V_{Rel}	T_{Abs}		T_{Rel}
			Org = (0,0)	Org = V_{XOffset} V_{YOffset}	
ΔX	$V_{\text{XRef}} - 0$	$V_{\text{XDif}} - V_{\text{XRef}}$	$V_{\text{XRef}} - 0$	$V_{\text{XRef}} - V_{\text{XOffset}}$	$V_{\text{XDif}} - V_{\text{XRef}}$
ΔY	$V_{\text{YRef}} - 0$	$V_{\text{YDif}} - V_{\text{YRef}}$	$V_{\text{YRef}} - 0$	$V_{\text{YRef}} - V_{\text{YOffset}}$	$V_{\text{YDif}} - V_{\text{YRef}}$

Where

- V_{Abs} = Absolute Voltage cursors
- V_{Rel} = Relative Voltage cursors
- T_{Abs} = Absolute Time cursors
- T_{Rel} = Relative Time cursors
- Org = Origin
- V_{XRef} = Voltage of the reference cursor on the X trace
- V_{YRef} = Voltage of the reference cursor on the Y trace
- V_{XDif} = Voltage of the difference cursor on the X trace
- V_{YDif} = Voltage of the difference cursor on the Y trace

Selecting the Reference Point

In order to make the polar readout of the absolute time cursor more useful, there is the possibility of choosing between two reference points. The reference is either located at point (0, 0), i.e. at X = 0 Volt and Y = 0 Volt, or at the center of the square grid. Menu button (9), active only in absolute time cursor mode, toggles the displacement of the reference origin to the center of the grid ON and OFF.

The values of the origin are displayed on the left-hand side of the square grid. By changing the offsets of the source traces the user can center a figure on the screen and then measure angles and distances with respect to the center of the figure.

STORE MENU

The Store button (1) enables the user to store any of the traces in the oscilloscope's acquisition memories into reference Memories C and/or D.

To store the currently acquired waveform, press button (1) and respond to the messages displayed to the left of the grid. The options are shown in Figure 37.

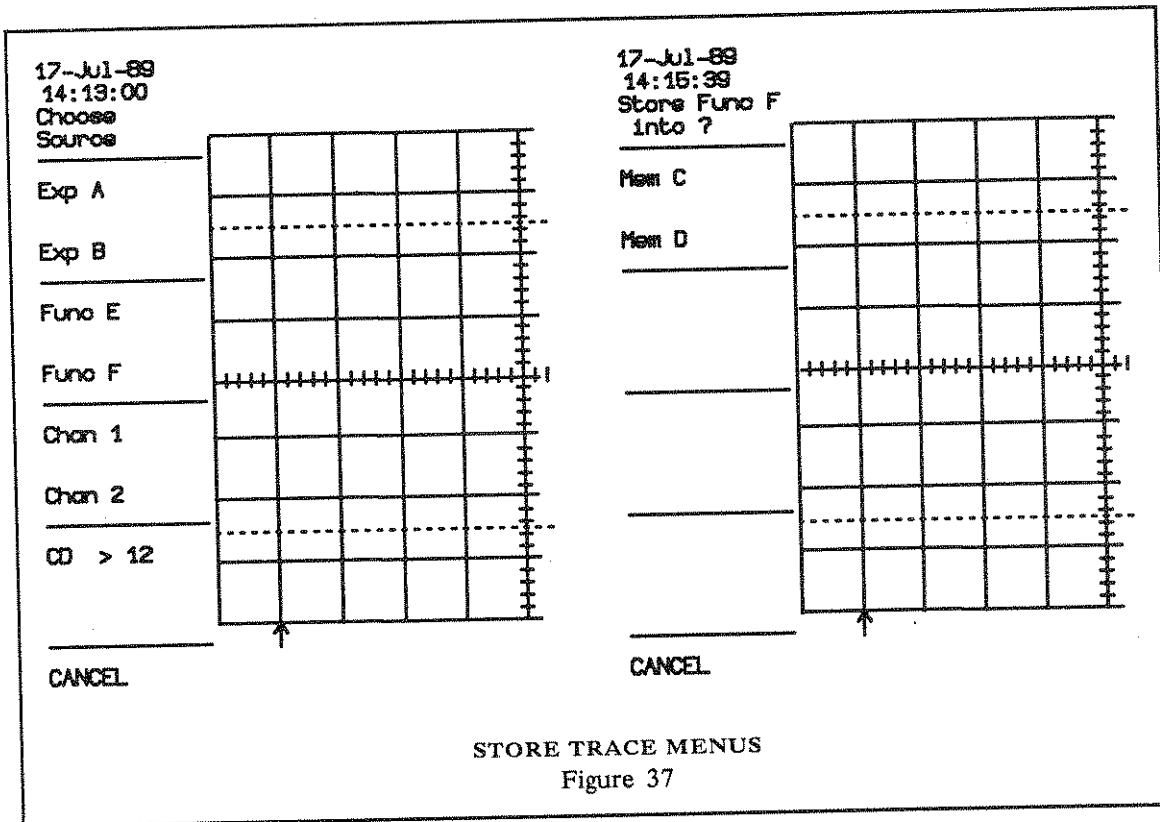

Whenever the user wishes to switch off the oscilloscope but still store data in the oscilloscope's non-volatile acquisition memories (Channels 1 and 2), the CD > 12 transfer is particularly useful. Once button (8) is pressed, data are automatically transferred from the volatile reference memories to the non-volatile acquisition memories. The oscilloscope is also switched to the single trigger mode so that further acquisitions cannot overwrite the stored data. The oscilloscope can now be safely switched off. At power ON, the contents of Channels 1 and 2 will be transferred back into Memories C and D.

Note: Users should be aware that Memories C and D are volatile and will be erased when the oscilloscope is switched off. For non-volatile storage, use the CD > 12 button (8) before switching off the oscilloscope.

SPECIAL MODES

The Special Modes menu (Figure 38) is entered by pressing button (8) in the Panel Status menu (Figure 21). The menu allows the user to control the External Time base and/or the Continuous Sequence mode.

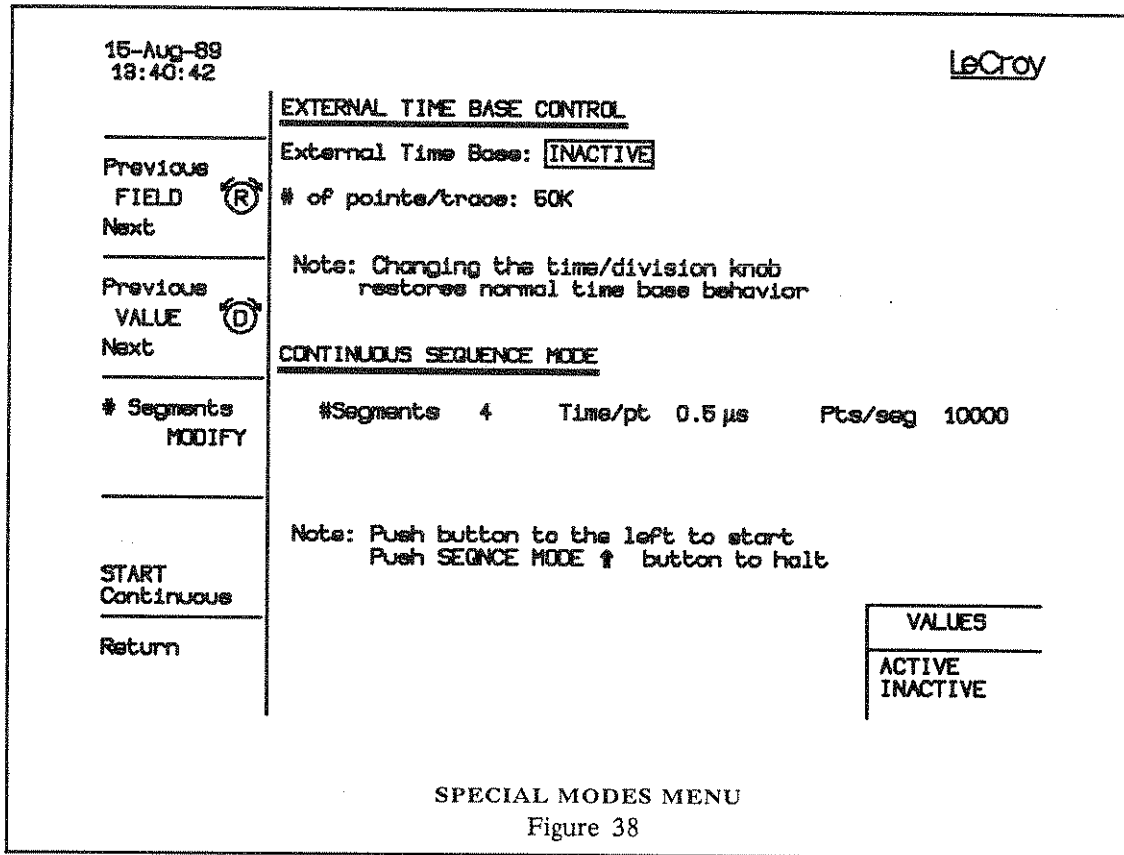

Use the Reference knob (42) or buttons (2) and (3) to scroll through the parameters. Note that the options available for each parameter are indicated on the lower right-hand edge of the screen. Use the Difference knob (42) or buttons (3) and (4) to choose the required option.

External Time Base Control

The **External Clock Input** (55) allows the users to drive the ADCs of the oscilloscope using their own clock signal. Typical applications involve the use of very high-precision clocks or clocks that provide variable or non-standard frequencies.

For the specifications of the external clock see Section 8.

Operation of the **External Clock Input** is switched ON once the External Time Base has been set to active in the Special Modes menu (Figure 38). The oscilloscope will require a number of pulses (typically between 20 to 100) before it recognizes the external clock signal. Once the external clock signal has been detected, its rising edge is used to clock the ADCs of the oscilloscope. No attempt is made to measure the time difference between the trigger and the external clock. The acquisition is halted only when the trigger conditions have been satisfied and the appropriate number of data points has been accumulated. The user can select the trigger delay in the same way as for an internal time base acquisition. As the input frequency of the external clock signal is unknown, information relating to post-trigger settings and cursors (including parameters) is expressed in samples rather than seconds.

The sequence acquisition modes can be used with the external clock. However, users should be aware that the sequence time stamps are generated by the internal time clock and are not corrected for the acquisition delay or duration.

The oscilloscope's random interleaved sampling mode is not available when using an external clock.

Any adjustment to the **Time/Division** knob (41) automatically returns the oscilloscope to normal (internal) clock operation. Alternatively, the External Time Base can be switched OFF by selecting **Inactive** in the special modes menu.

Continuous Sequence Mode

This mode of operation is a special form of sequence acquisition and continuously stores waveforms in segmented memory as long as triggers are received. Once triggering stops, the user can inspect the entire contents of acquisition memory to inspect the last N waveforms (where N is the number of segments selected in the Special Modes menu). The number of waveforms stored may be selected by pressing the **# Segments Modify** button (6). The acquisition of waveforms can only be started by using the **Start Continuous** button (9). Acquisition of waveforms will continue until no more triggers are received. The user can then inspect the waveforms by pressing the **Seqnce** button (28). Pressing the **Seqnce** button during acquisition terminates the Continuous Sequence Mode and allows the user to view the last N waveforms.

6 Manual Operation

Note: In this mode of operation, if the trigger rate is high (7500 triggers/second), the oscilloscope may appear to freeze in operation. If this happens, remove the trigger source and normal response will be restored.

THE SMART TRIGGER

Note: In the following sections, roman numerals in parentheses refer to the display field numbering scheme in Figure 6. Arabic numerals relate to the numbering scheme used to refer to front- and rear-panel controls and connectors in Figures 1 and 3 (9420) or Figures 2 and 3 (9450).

INTRODUCTION

Two levels of triggering are available in the 9420/50, the standard trigger and the SMART trigger. Operation of the standard trigger is covered in Section 6. There are five basic operational modes within the SMART trigger as shown in Figure 39.

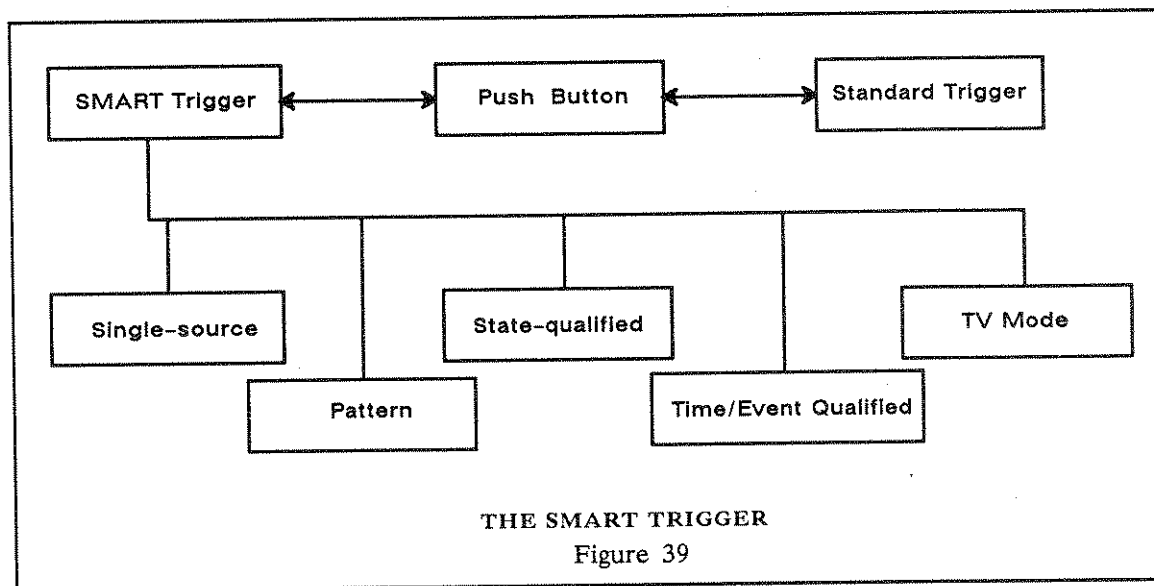

APPLICATIONS

To capture rare phenomena such as glitches or spikes, logic states or missing bits, an oscilloscope must be able to trigger on elusive events. The 9420/50 offers the user a variety of sophisticated trigger modes based on two important facilities:

- a) The ability, by using a counter which can be pre-set, to count a specified number of events (1 to 10^9), or alternatively to measure time intervals up to 20 sec.

This feature can be applied either to introduce a post-trigger hold-off, which can be set as a number of events or as a time interval, or to trigger on pulse widths or on pulse separations greater or smaller than a value chosen by the user, or to count the time or number of events after a starting condition before allowing a trigger.

- b) The ability to sense the logic state of the trigger sources Channel 1, Channel 2 and External, and to trigger on a chosen logic combination.

Single-source Triggers

There are two types of single-source triggers in the 9420/50. These are the Hold-off and Width-based triggers. Details of how to set up these triggers are given later in this section.

Hold-off

Trigger hold-off is required to get a stable display of complex repetitive waveforms. Depending on the application, the waveforms may consist of a sequence of digital pulses or pure analog pulses. Therefore, it may sometimes be convenient to define the hold-off in terms of number of pulses, and in terms of time for other applications, even though both may give rise to the same result. What is important is that the hold-off has to be a multiple of the period of the complex waveform, where the period is measured in terms of time or number of events.

It should be noted that the hold-off is started by potential triggers (and not at the end of an acquisition). Potential triggers will be accepted if the oscilloscope is armed but will be ignored if the oscilloscope is still busy handling the previous trigger. In fact the hold-off ensures synchronization between successive real triggers.

Width-based Trigger

The width-based trigger is a major innovation in oscilloscopes. Two possibilities exist:

- a) **Pulse Width**, i.e. the time from the trigger source transition of a given slope to the next transition of *opposite* slope.
- b) **Interval Width**, i.e. the time from the trigger source transition of a given slope to the next transition of the *same* slope.

After selecting a pulse or an interval width, the user can choose to trigger on widths smaller or greater than the given value. This feature offers a wide range of capabilities for application fields as diverse as digital and analog electronic development, ATE, EMI, telecommunications, and magnetic media studies. Catching elusive rare glitches becomes very easy. In digital electronics, where the circuit under test normally uses an internal clock, a glitch can be theoretically defined as any pulse which has a width smaller than the clock period (or half period). The 9420/50 can selectively trigger only on those events.

In a much broader sense, a glitch can be defined as a pulse much faster than the waveform under observation. Glitches are a source of problems in many applications. Therefore, the possibility of triggering on a glitch, investigating what generated it and measuring the damage caused by it, represents a fundamental tool.

The trigger on pulse widths smaller than a given value has been named FASTGLITCH.

FASTGLITCH trigger mode, like the other modes, can be selected at any time-base setting. The user can define widths with 2.5 nsec resolution starting at a minimum value of 2.5 nsec. For recurrent glitches, the oscilloscope's random interleaved sampling mode allows glitch visualization with an equivalent sampling rate of up to 10 gigasamples/sec, that is one sample point every 100 psec.

Missing bits in long data streams are easily triggered on using the interval width triggering facility. For ranging applications, interval trigger may be used to ignore unwanted signal reflections.

Multi-source Triggers

There are four types of multi-source triggers in the 9420/50. These are the Pattern, State-qualified, Time/Event Qualified and TV triggers. Details of how to set up these triggers are given later in this section.

Pattern Trigger

A pattern trigger is defined as a logical AND combination of the states of Channel 1, Channel 2 and External. The states are defined as being either low (L) or high (H) or don't care (X) with respect to the individually defined trigger thresholds. Furthermore the user decides whether the oscilloscope should trigger at the beginning of the defined pattern or at the end, i.e. when the pattern is "entered" or "exited".

The FASTGLITCH and time-separation trigger capabilities described above can be combined with pattern trigger, enabling the user to compare the "duration" of the pattern trigger, or the interval between patterns, with a reference time. This also applies to the hold-off by time or number of events.

The pattern trigger will be appreciated every time complex logic has to be tested. Examples are: computer or microprocessor debugging; High Energy Physics where a physical event is identified by several events occurring simultaneously; and debugging of data transmission busses in telecommunications.

When set to pattern trigger, the 9420/50 always checks the logic AND of the defined input logic states. However, with the help of de Morgan's laws, the pattern becomes much more general. To demonstrate this, consider an example which is of particular importance, that is a *bi-level or window trigger*.

Bi-level trigger means that the user is expecting a single-shot signal where the amplitude will go outside a known range in either direction.

A bi-level trigger can be set up as follows. The signal should be connected to two inputs, Channel 1 and Channel 2 (or Channel 1 and External , or Channel 2 and External). The threshold of Channel 1 should be set to +100 mV and the threshold of Channel 2 to -200 mV for example. The required bi-level trigger will occur if the oscilloscope triggers on Channel 1 for any pulse greater than + 100 mV *or* on Channel 2 for any pulse more negative than - 200 mV. For improved precision, the gains of the two channels should be at the same setting.

In Boolean notation we can write:

$$\text{Trigger} = \text{CH1} + \overline{\text{CH2}}$$

i.e. trigger when entering the pattern

$$\text{CH1} = \text{high OR CH2} = \text{low}$$

By de Morgan's laws this is equivalent to:

$$\text{Trigger} = \overline{\text{CH1}} \cdot \text{CH2}$$

i.e. trigger when exiting the pattern

$$\text{CH1} = \text{low AND CH2} = \text{high}$$

This configuration can be programmed easily.

The possibility of setting the threshold individually for each channel extends this method to a more general window trigger where, in order to have a trigger, it is required that the input pulse amplitude lies within or outside a given arbitrary window.

Another important aspect of the pattern trigger is that all the features already examined for the single-source trigger mode can also be used. That is, the user again has the choice of imposing a hold-off by time or by number of events or alternatively to compare the "duration" or the intervals which are greater or smaller than a time duration specified by the user.

The pattern trigger has been designed to let the user choose the trigger point. By choosing LHX entering, the trigger will be given at the moment that the pattern LHX becomes true. If we now add the condition pattern width < reference time, this will refer to the width of the pattern $\overline{\text{LHX}}$ preceding the trigger point. Therefore, this trigger mode checks the repetition rate of the pattern.

On the other hand, if LHX exiting is chosen with pattern width < reference time, then the duration of the LHX state will be compared with the reference time and the trigger will be given when LHX becomes false. See Figure 40.

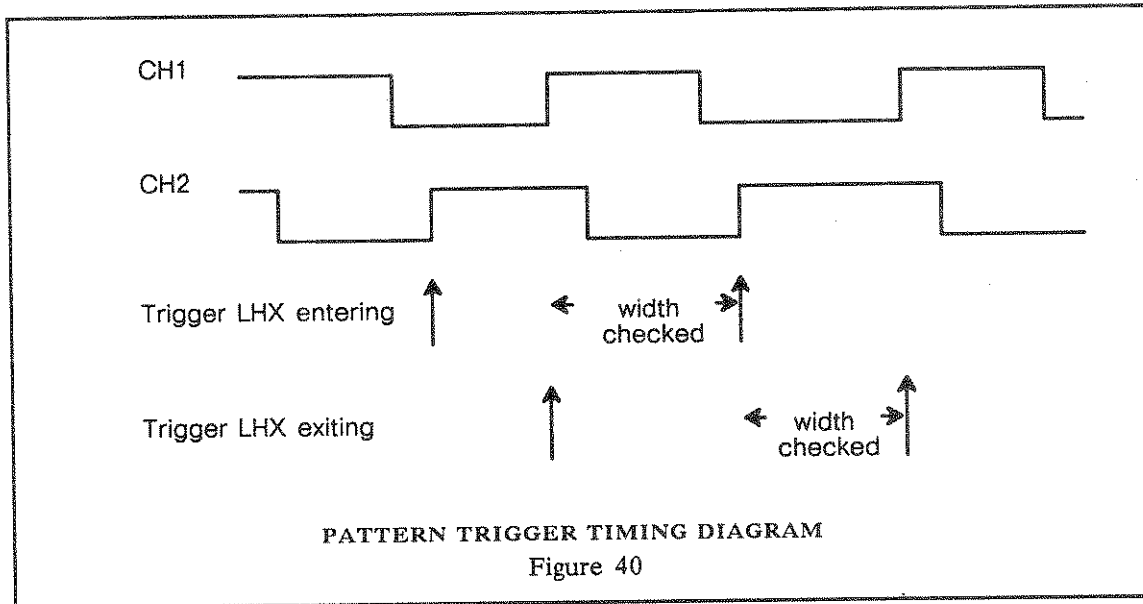

7 The Smart Trigger

State-qualified Trigger

In this mode a transition into a user-defined logic state of two inputs starts a predetermined time delay or trigger count. The logic state serves as an enabling condition to the third input which is the source of the trigger. The logic state must remain valid in order that the trigger occurs (see Figure 41). It is important to note that the time delay or trigger count is restarted every time the logic state is entered.

Typical applications can be found wherever time violations may occur, for example in micro-processor debugging or telecommunications.

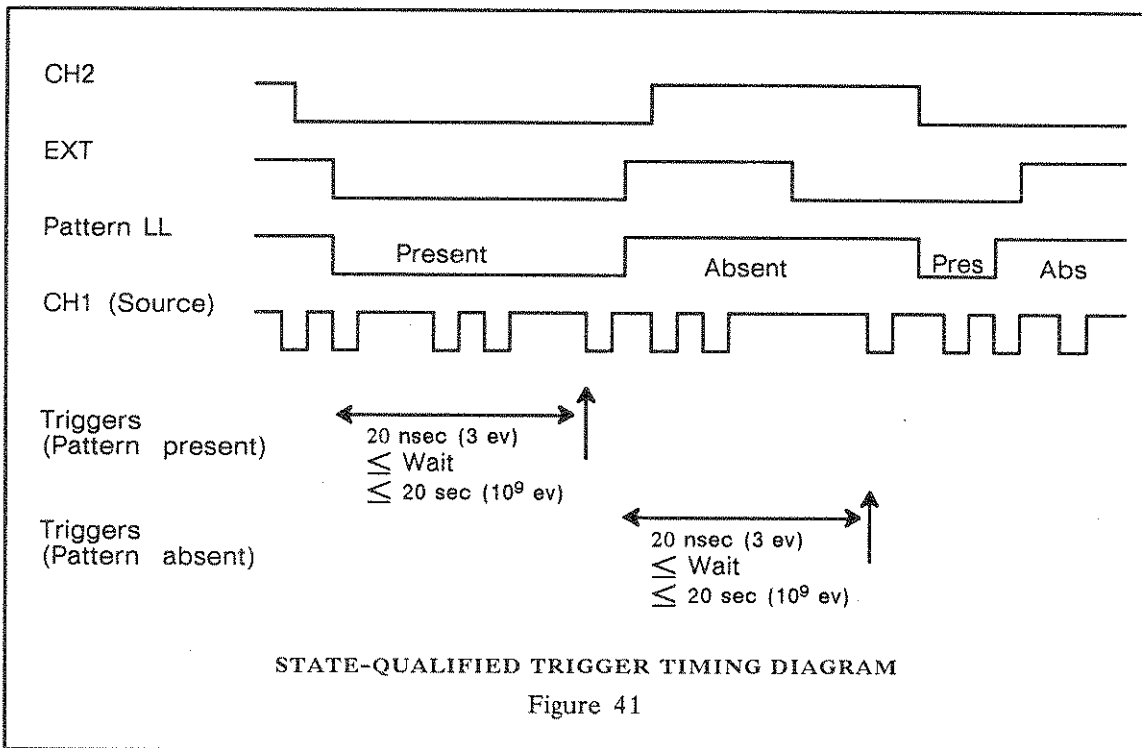

Time/Event
Qualified Trigger

This trigger is similar to the State-qualified trigger. The differences are that the logic state can be defined on all three inputs and that the logic state is not required to remain valid in order to have a trigger. Therefore, the logic state starts a delay by time or number of events after which triggering is enabled (see Figure 42). It should be noted that, unlike the state-qualified trigger, the delay is not restarted by every transition into the state. The trigger must occur or the acquisition must be stopped and restarted (by changing the trigger mode from Norm to Single to Norm or from Single armed to Single Trig'd to Single armed).

This trigger mode provides a solution to applications involving systems with long firing jitter time, e.g. lasers and magnetic discs.

Other applications for the Time/Event qualified trigger can be found in telecommunications or microprocessors for debugging of asynchronous data buses.

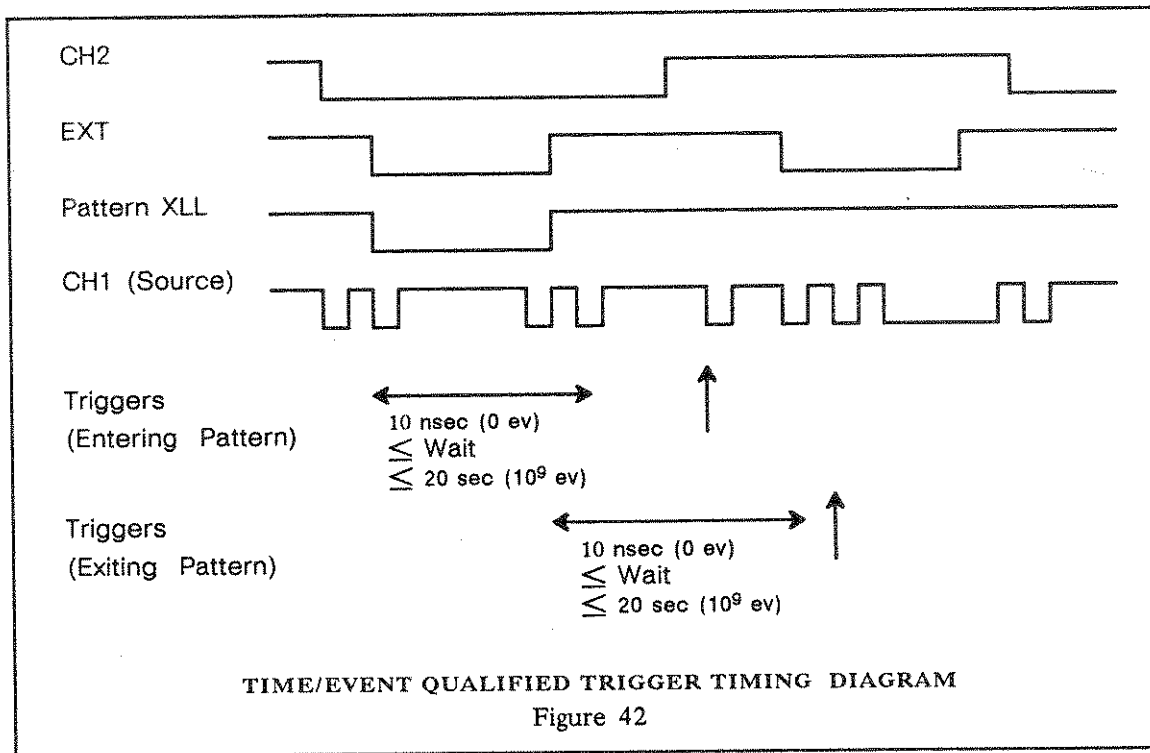

TV trigger

This trigger is a special form of the Time/Event qualified trigger. A composite video signal on the external trigger input is analyzed to provide a signal for the beginning of the chosen field (any, odd, or even) and a signal at the beginning of each line. The field signal provides the starting transition and the beginning of line pulses are counted to allow the final trigger on the chosen line. LeCroy's TV trigger includes an enhanced field counting capability which can maintain the trigger on a known field relative to some initial trigger (FIELDLOCK). The field, number of fields and the field rate, interlace factor, and number of lines/picture must be specified for this feature. Standard settings exist for the most popular forms of TV signals. The TV trigger can also function in a simple any line mode. Applications can be found wherever TV signals are present.

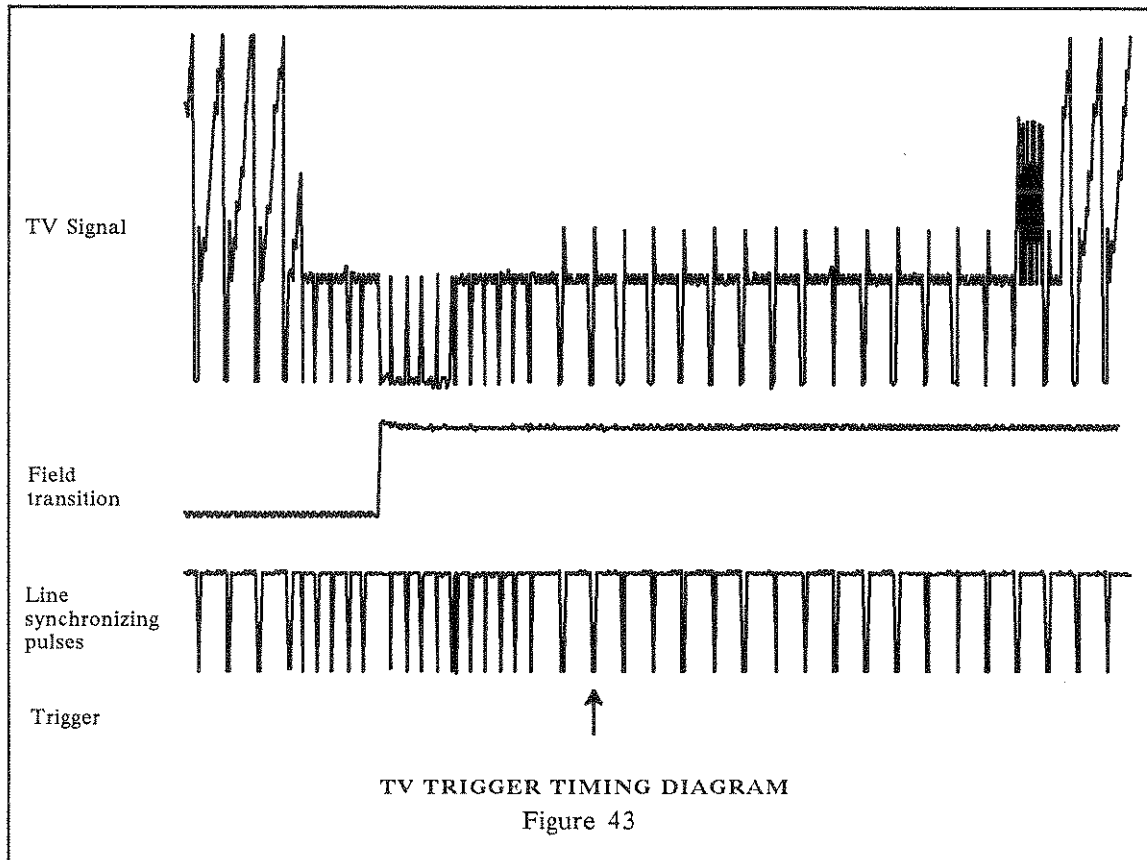

**MANIPULATING
THE SMART TRIGGER**

SMART Trigger Controls

Full details of setting the standard trigger parameters, delay, level, slope, coupling and mode are given in Section 6.

SMART Trigger, button (35), switches between the SMART and standard trigger modes.

DELAY, **LEVEL** and **VALUE** are selected using button (39) and set using the **Adjust** knob (37). **Value** can only be used and adjusted when the oscilloscope is in the SMART trigger mode. Figure 44 shows the SMART trigger controls.

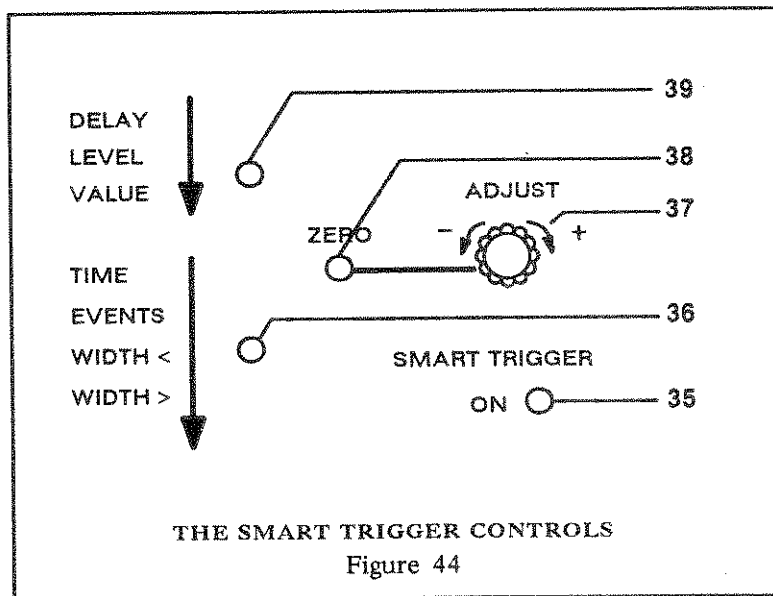

Delay and Level may be set to 0 by pressing the Zero button (38). When Value is used in conjunction with a hold-off by time or number of events, pressing Zero sets the hold-off to the minimum value of 12.5 nsec or 0 events respectively. When it is used with Width trigger, pressing the Zero button sets the width to its minimum value for each particular trigger mode.

TIME, EVENTS, WIDTH <, and WIDTH > are selected using button (36) and their settings can be adjusted using the Adjust knob (37), when the Value LED is lit.

SMART Trigger Menu

The SMART trigger is switched on and off using the SMART Trigger button (35). The ON LED beside the button lights and the following message appears in the message field (IX):

Inspect/Modify SMART TRIG in Panel Status menu.

Note that the SMART trigger remains configured as it was when it was previously used. SMART trigger configurations are also stored when a front-panel setup is stored using the **Save Panel** button (4) in the Main menu.

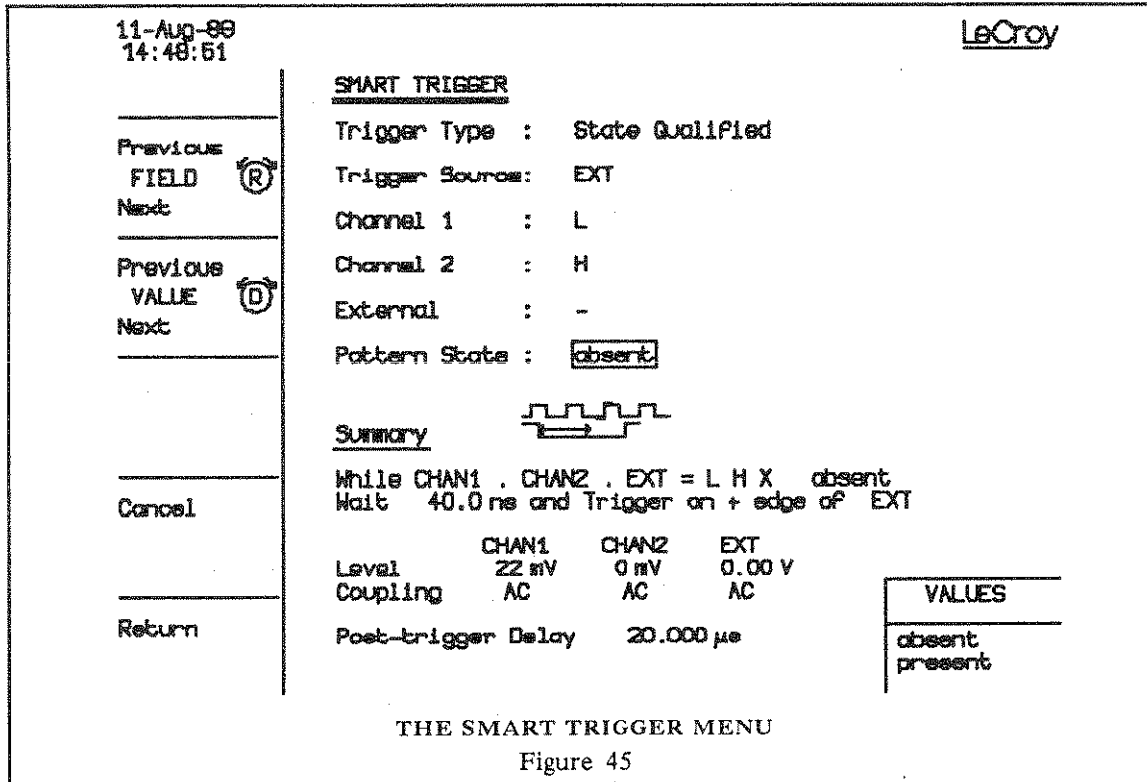

Buttons (2) and (3) and the **Reference** button (42) allow the user to select the required parameter. Buttons (4) and (5) and the **Difference** button (42) are used to adjust a selected parameter.

Pressing **Cancel**, button (8), returns the oscilloscope to the SMART trigger configuration which was set when the menu was first entered. Pressing **Return**, button (10), returns the oscilloscope to the Panel Status menu.

Trigger Graphics

To help the user rapidly interpret SMART trigger configurations, a visual indication of the trigger is given by the oscilloscope's special trigger graphics. Examples of typical SMART trigger graphics, together with descriptions are given in Figure 46.

Pattern L H X exited

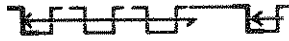

H'off 100.0 ns

Pattern Trigger

Trigger on Chan1 . Chan 2 . Ext = L H X exited
followed by a hold-off by 100 nsec

CH1 84 mV DC



Wait 60 010 860 evts

State-qualified Trigger

While the states Chan1 . Chan 2 . Ext = X H X are absent
wait for 60,010,860 events and trigger on a + edge of Chan1

CH2 0.00 V AC

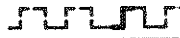

Wait 25 evts

Time/events Qualified Trigger

After Chan1 . Chan2 . Ext = H H X exited
Wait for 25 events and trigger on a + edge of Chan2

TV EXT



Line 8

Trigger on EXT TV signal, line 8, any field

SMART TRIGGER GRAPHICS

Figure 46

SINGLE-SOURCE TRIGGER MODES

The Single-source trigger is schematically represented in Figure 47.

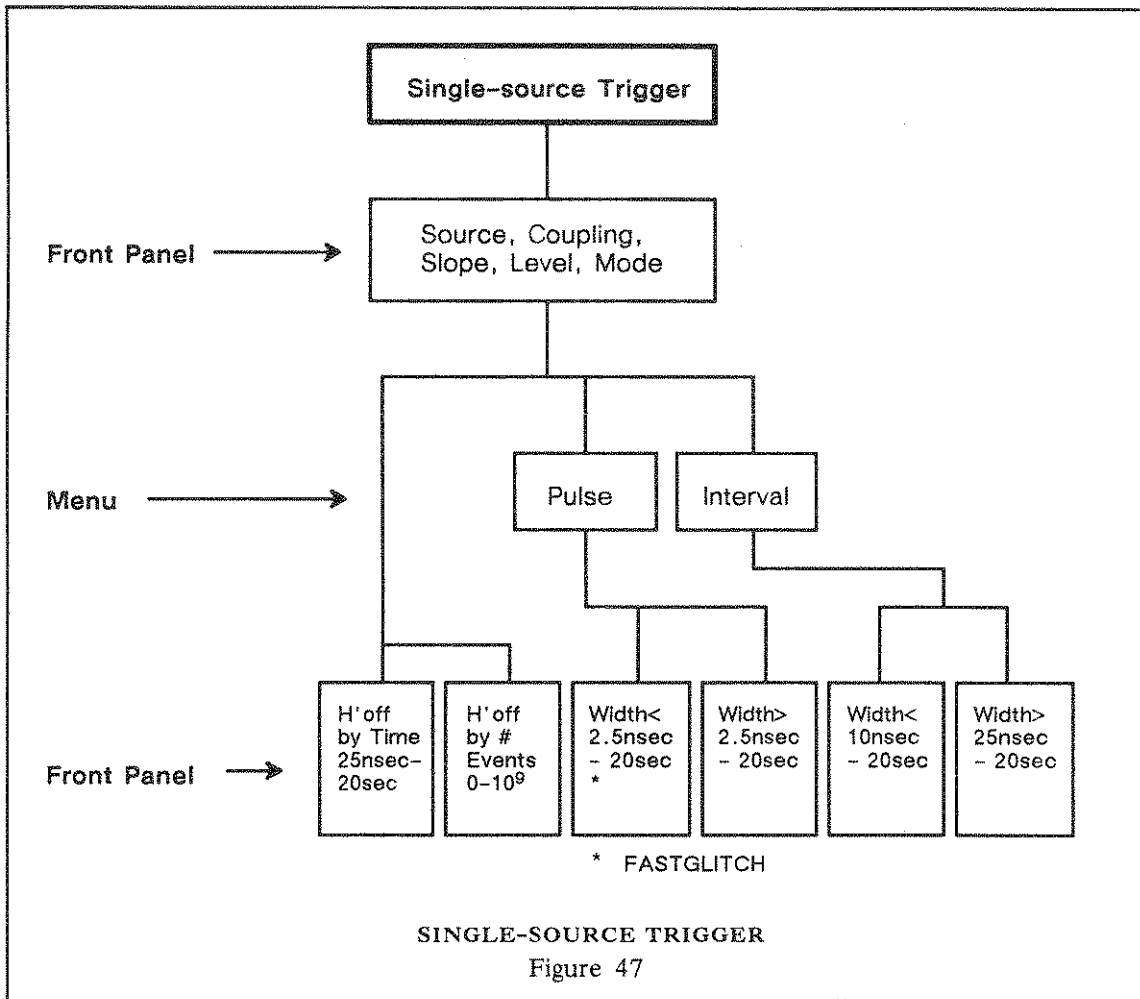

Hold-off

Two different hold-offs are available:

Hold-off by time: 25 nsec to 20 sec

Hold-off by number of events: 0 to 1,000,000,000 events.

Pressing the **Zero** button (38) sets the hold-off to the minimum value.

Hold-off By Time

- 1) Set the trigger **Level, Delay, Coupling, Slope** and **Source** as required. These parameters can be set before or after entering the SMART trigger menu. However, they must be set when the SMART trigger is OFF.
- 2) Ensure that the SMART trigger is switched ON. (The LED beside button (35) should be lit.)
- 3) Press **Modify SMART Trig** in the panel status menu to enter the SMART trigger menu.
- 4) Use buttons (2) and (3) or the **Reference** button to select **Trigger Type**.
- 5) Use buttons (4) and (5) or the **Difference** button to set **Trigger Type** to **Single Source**.
- 6) Select **Value** using button (39).
- 7) Select **Time** using button (36). Figure 48 shows the screen display. (Note that although **Width Type** is indicated on the screen it is only relevant if either the **Width <** or **Width >** LEDs are lit.)

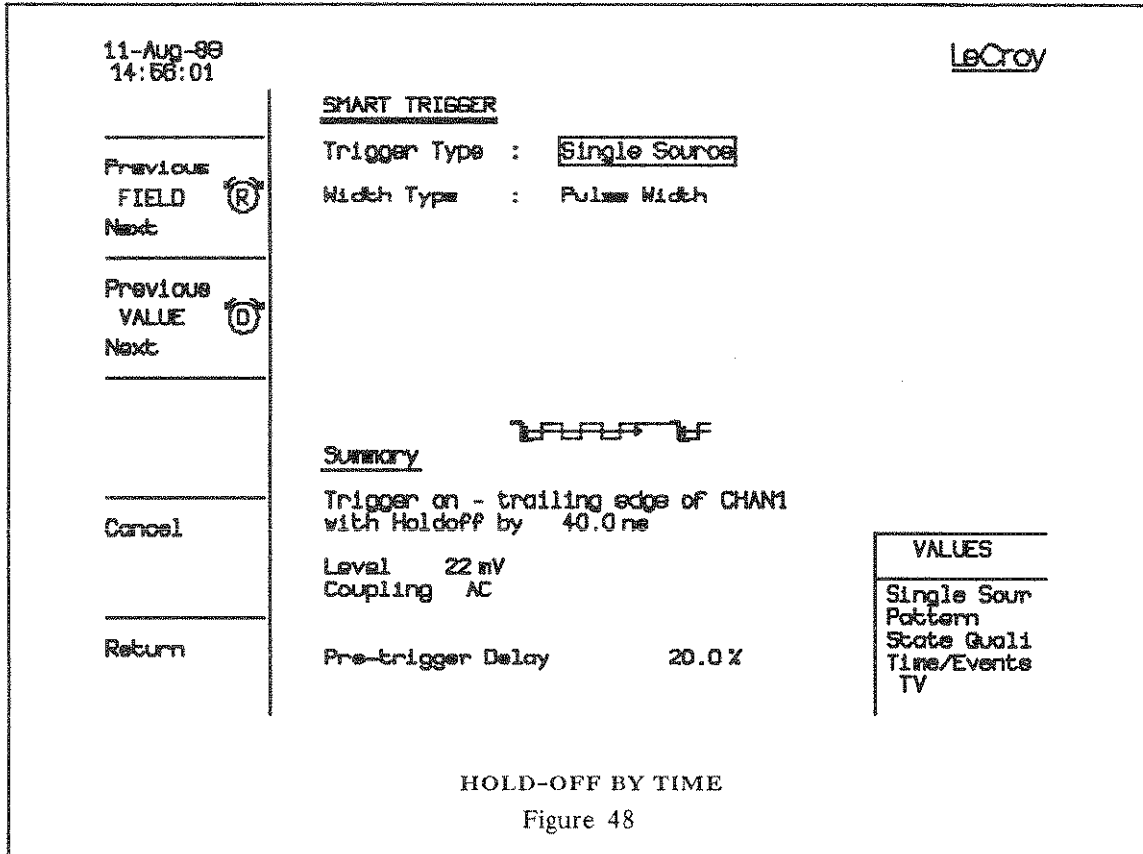

- 8) The Adjust button can then be used to set the hold-off (in the range 25 nsec through 20 sec).
- 9) The minimum hold-off can be obtained by pressing the Zero button (38). This gives a 12.5 nsec hold-off. The screen shows: No wait.

Hold-off By
Number Of Events

- 1) Set the trigger Level, Delay, Coupling, Slope and Source as required. These parameters can be set before or after entering the SMART trigger menu. However they should be set when the SMART trigger is OFF.
- 2) Ensure that the SMART trigger is switched ON. (The LED beside button (35) should be lit.)

- 3) Press **Modify SMART Trig** in the Panel Status menu to enter the SMART trigger menu.
- 4) Use buttons (2) and (3) or the **Reference** button to select **Trigger Type**.
- 5) Use buttons (4) and (5) or the **Difference** button to set **Trigger Type** to **Single Source**.
- 6) Select **Value** using button (39).
- 7) Select **Events** using button (36). Figure 49 shows the screen display. (Note that although **Width Type** is indicated on the screen it is only relevant if either the **Width <** or **Width >** LEDs are lit.)

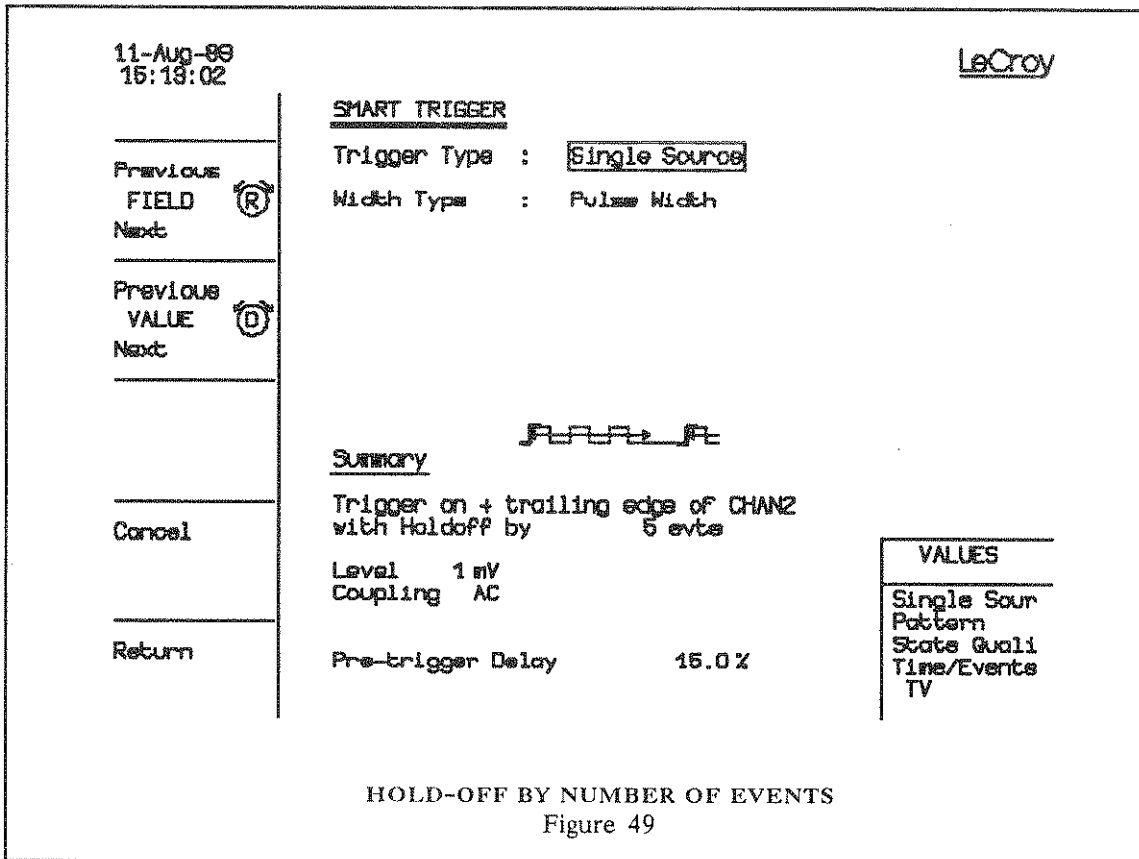

- 8) The **Adjust** button can then be used to set the hold-off (in the range 1 event through 10⁹ events).

- 9) If no hold-off by events is required, press the **ZERO** button (38). In this case a minimum hold-off of 12.5 nsec will occur.

Pulse Width-based Trigger Modes

Width-based triggers operate on a given pulse width, or a given interval between pulses. Two pulse-width based triggers are available as shown in Figure 50 and described below:

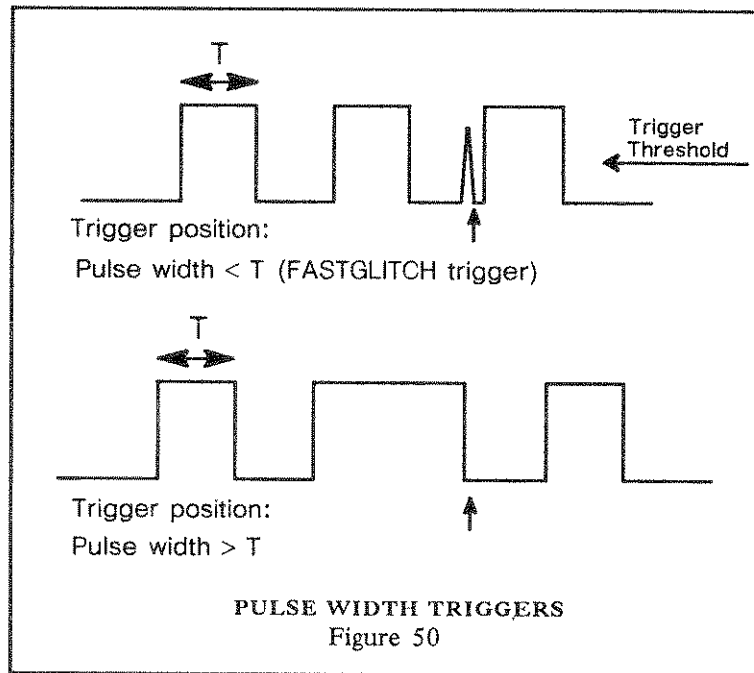

Pulse width < a specified pulse width (FASTGLITCH): The 9420/50 triggers on opposite slopes of pulses narrower than a specified value. Values in the range 2.5 nsec through 20 sec may be chosen.

Pulse width > a specified pulse width: The 9420/50 triggers on opposite slopes of pulses wider than a specified value. Values in the range 2.5 nsec through 20 sec may be entered.

Pulse Width <
A Specified Value
(FASTGLITCH)

- 1) Set the trigger **Level, Delay, Coupling, Slope** and **Source** as required. These parameters can be set before or after entering the SMART trigger menu. However, they must be set when the SMART trigger is OFF.
- 2) Ensure that the SMART trigger is switched ON. (The LED beside button (35) should be lit.)
- 3) Press **Modify SMART Trig** in the Panel Status menu to enter the SMART trigger menu.
- 4) Use buttons (2) and (3) or the **Reference** button to select **Trigger Type**.
- 5) Use buttons (4) and (5) or the **Difference** button to set **Trigger Type** to **Single Source**.
- 6) Use buttons (2) and (3) or the **Reference** button to select **Width Type**.
- 7) Use buttons (4) and (5) or the **Difference** button to set **Width Type** to **Pulse Width**.
- 8) Select **Value** using button (39).
- 9) Select **Width <** using button (36). Figure 51 shows the screen display.
- 10) The **Adjust** button can then be used to set the pulse width (in the range 2.5 nsec through 20 sec).

Note: The separation between the leading edges of two consecutive pulses should be greater than 10 nsec to correctly measure the width. If this condition is not satisfied, the width measurement can be affected by a maximum error of 10 nsec.

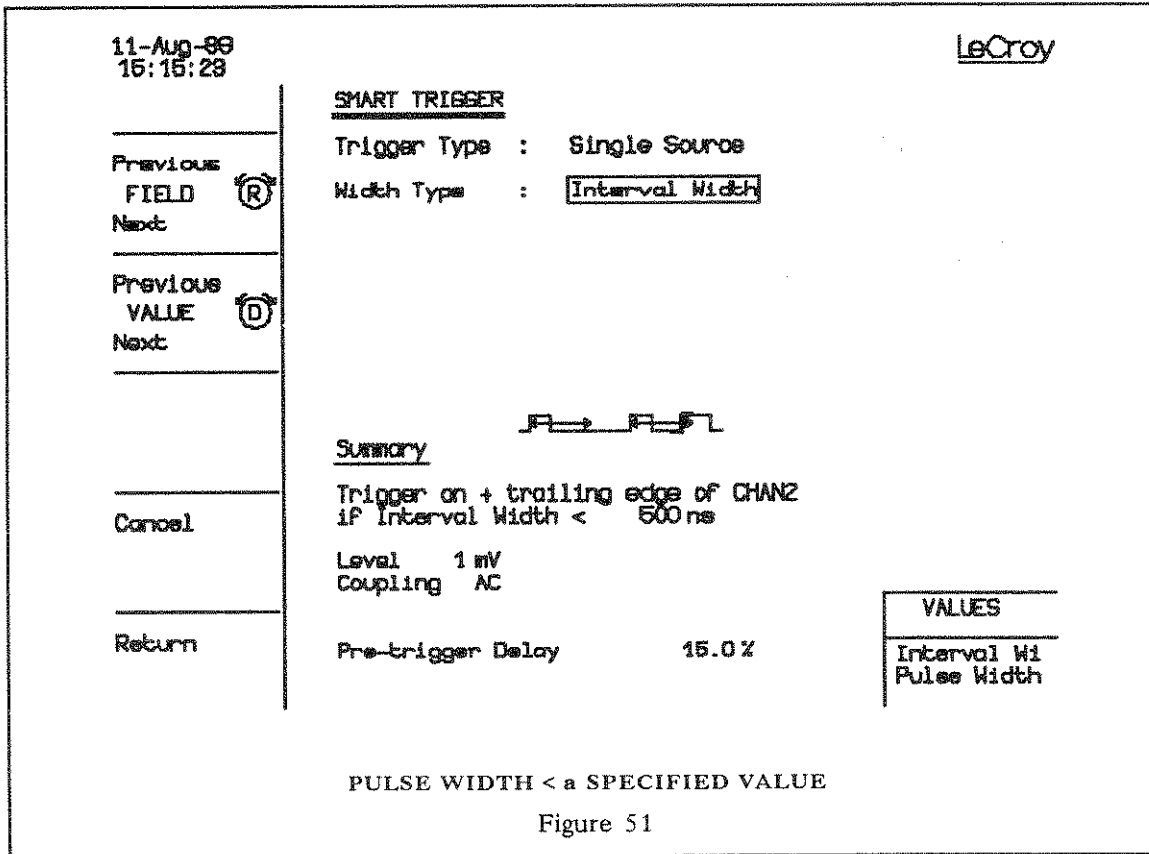

Pulse Width >
a Specified Value

- 1) Set the trigger Level, Delay, Coupling, Slope and Source as required. Note that they can also be set after entering the SMART trigger menu. However, they must be set when the SMART trigger is OFF.
- 2) Ensure that the SMART trigger is switched ON. (The LED beside button (35) should be lit.)
- 3) Press Modify SMART Trig in the Panel Status menu to enter the SMART trigger menu.
- 4) Use buttons (2) and (3) or the Reference button to select Trigger Type.
- 5) Use buttons (4) and (5) or the Difference button to set Trigger Type to Single Source.

- 6) Use buttons (2) and (3) or the **Reference** button to select **Width Type**.
- 7) Use buttons (4) and (5) or the **Difference** button to set **Width Type** to **Pulse Width**.
- 8) Select **Value** using button (39).
- 9) Select **Width >** using button (36).
- 10) The **Adjust** button can then be used to set the pulse width (in the range 2.5 nsec through 20 sec).

Interval Width based Trigger Modes

Two interval width based triggers are available as indicated in Figure 52 and described below.

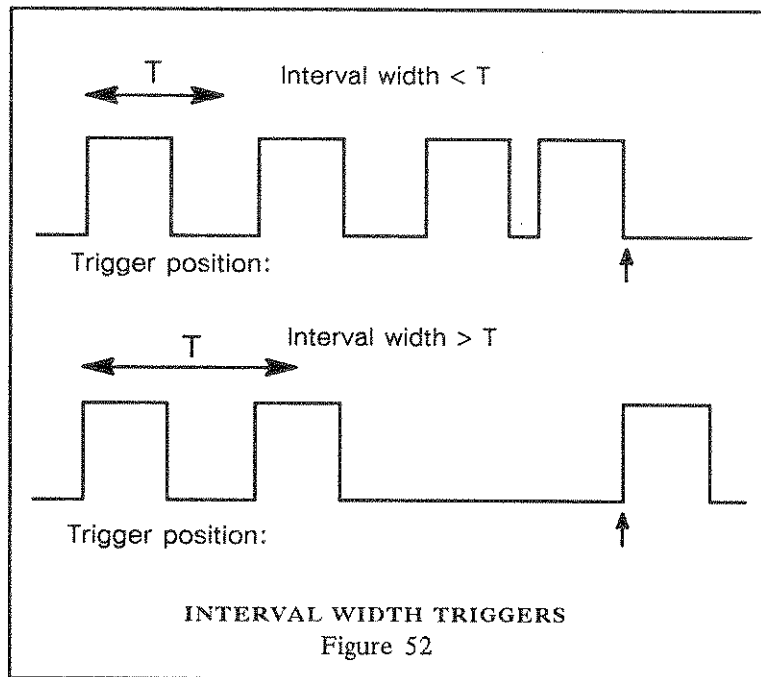

Interval Width < a Specified Width: The oscilloscope triggers on similar slopes of signals narrower than a value in the range 10 nsec through 20 sec.

Interval Width > a Specified Width: The oscilloscope triggers on similar slopes of signals wider than a value in the range 25 nsec through 20 sec.

7 *The Smart Trigger*

Interval Width < A Specified Value

- 1) Set the trigger **Level, Delay, Coupling, Slope** and **Source** as required. These parameters can be set before or after entering the SMART trigger menu. However, they must be set when the SMART trigger is OFF.
- 2) Ensure that the SMART trigger is switched ON. (The LED beside button (35) should be lit.)
- 3) Press **Modify SMART Trig** in the Panel Status menu to enter the SMART trigger menu.
- 4) Use buttons (2) and (3) or the **Reference** button to select **Trigger Type**.
- 5) Use buttons (4) and (5) or the **Difference** button to set **Trigger Type** to **Single Source**.
- 6) Use buttons (2) and (3) or the **Reference** button to select **Width Type**.
- 7) Use buttons (4) and (5) or the **Difference** button to set **Width Type** to **Interval Width**.
- 8) Select **Value** using button (39).
- 9) Select **Width <** using button (36). Figure 53 shows the screen display.
- 10) The **Adjust** button can then be used to set the interval width (in the range 10 nsec through 20 sec).

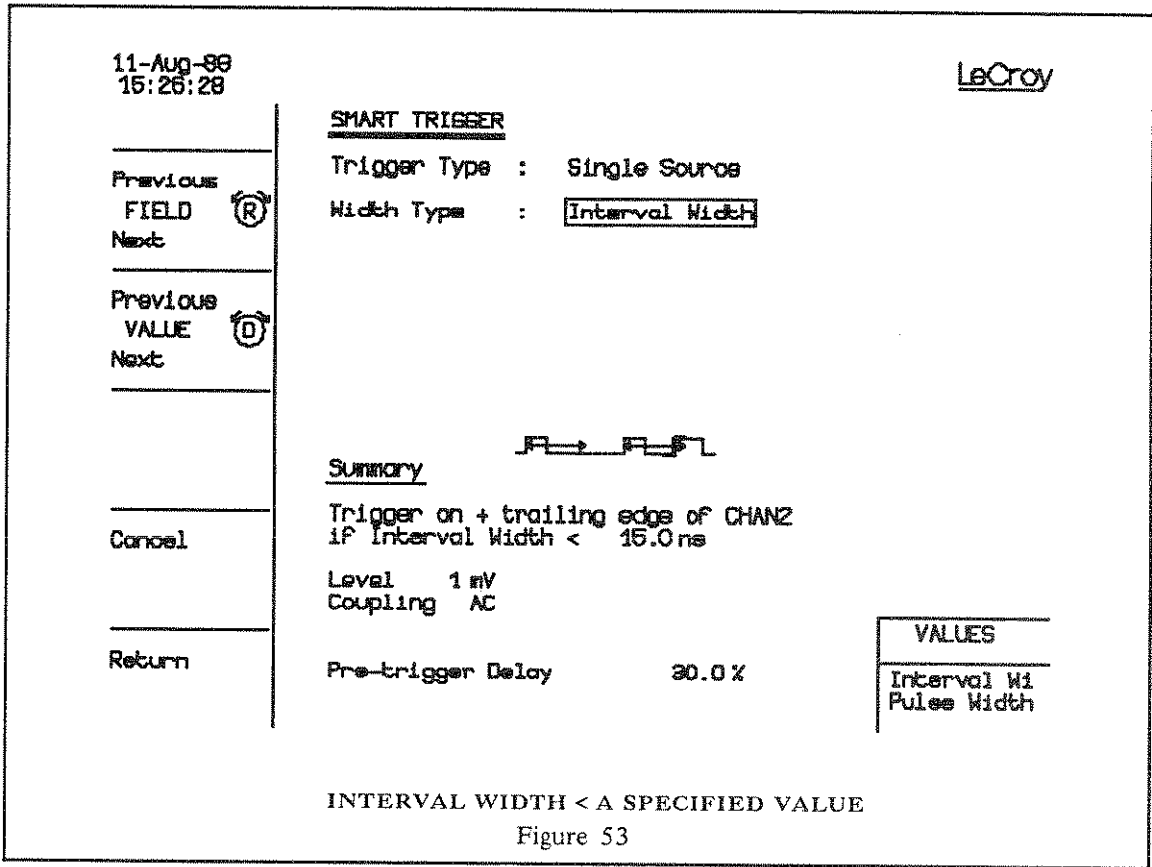

Interval Width >
A Specified Value

- 1) Set the trigger Level, Delay, Coupling, Slope and Source as required. These parameters can be set before or after entering the SMART trigger menu. However, they must be set when the SMART trigger is OFF.
- 2) Ensure that the SMART trigger is switched ON. (The LED beside button (35) should be lit.)
- 3) Press Modify SMART Trig in the Panel Status menu to enter the SMART trigger menu.
- 4) Use buttons (2) and (3) or the Reference button to select Trigger Type.
- 5) Use buttons (4) and (5) or the Difference button to set Trigger Type to Single Source.

- 6) Use buttons (2) and (3) or the **Reference** button to select **Width Type**.
- 7) Use buttons (4) and (5) or the **Difference** button to set **Width Type** to **Interval Width**.
- 8) Select **Value** using button (39).
- 9) Select **Width >** using button (36).
- 10) The **Adjust** button can then be used to set the interval width (in the range 25 nsec through 20 sec).

MULTI-SOURCE TRIGGER MODES

The 9420/50 has three trigger sources, CHAN 1, CHAN 2, and EXT, each of which can be defined as high (H), low (L) or don't care (X). By setting the sources as required several multi-source trigger features are available.

Pattern Trigger

The oscilloscope triggers on the logic AND of the three sources. The user can choose whether the oscilloscope triggers when the state is entered (i.e. as soon as the pattern is valid) or exited (i.e. when the pattern is no longer valid). The pattern trigger is schematically represented in Figure 54.

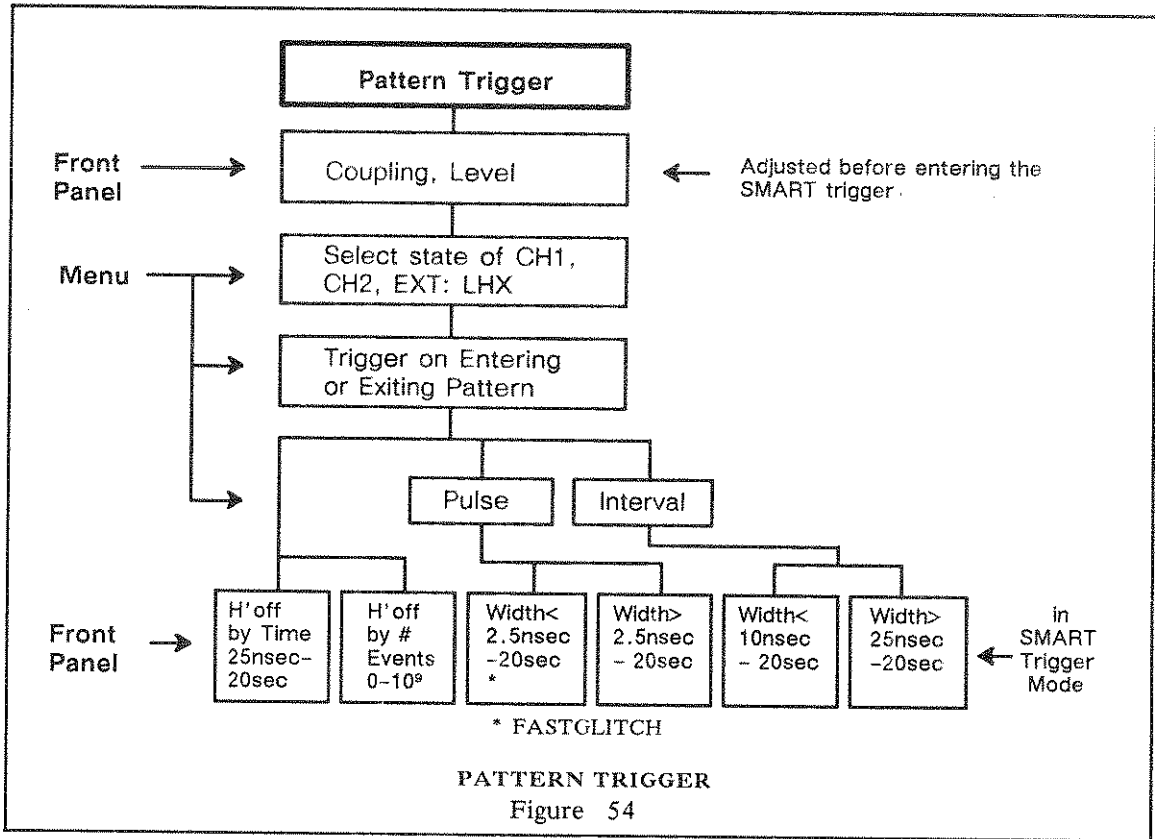

Note: To practice manipulating the SMART trigger, the user should configure at least one pulse/interval width trigger and one trigger with hold-off as described above before setting up the pattern, state-qualified or time/events qualified triggers.

7 The Smart Trigger

Adjusting the Pattern Trigger

- 1) Set the trigger **Level**, **Delay**, and **Coupling** for each source as required. These parameters can be set before or after entering the SMART trigger menu. However, they must be set while the SMART trigger is OFF.
- 2) Ensure that the SMART trigger is switched ON. (The LED beside button (35) should be lit.)
- 3) Press **Modify SMART Trig** in the panel status menu to enter the SMART trigger menu.
- 4) Use buttons (2) and (3) or the **Reference** button to select **Trigger Type**.
- 5) Use buttons (4) and (5) or the **Difference** button to set **Trigger Type** to **Pattern**. Figure 55 indicates a typical pattern trigger menu.

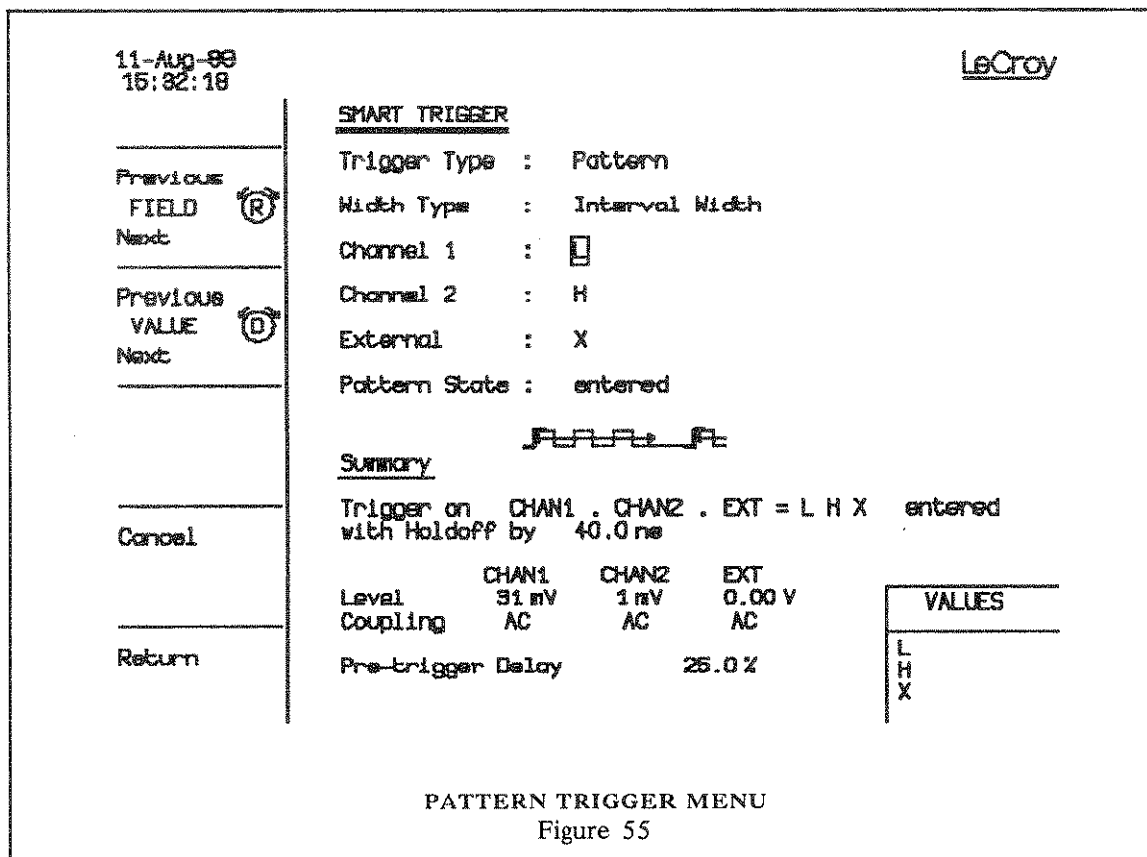

PATTERN TRIGGER MENU
Figure 55

To configure the pattern trigger the following parameters must be set:

* The pattern itself. Channel 1, Channel 2 and External can be set to either high (H), low (L) or don't care (X).

* Whether the 9420/50 should trigger when the pattern begins (entered) or when the pattern ends (exited).

* Other conditions, i.e.

Hold-off by time or events

Pulse width < or > than a specified value,

Interval width < or > than a specified value.

6) Use the **Reference** and **Difference** buttons to select and set Channel 1, Channel 2 and External to the required logic states.

7) Select **Pattern State** and set it to **entered** or **exited** as required.

8) There are now some further options:

a) Triggering independently of pattern width or interval width, with no hold-off.

Select **Value** using button (39).

Use button (36) to select **Time** or **Events** and then press the **Zero** button.

b) Triggering at the beginning or end of a pattern followed by a hold-off by time or events.

Select **Value** using button (39).

Use button (36) to select **Time** or **Events** and use the **Adjust** knob (37) to set the hold-off as required.

Range: Hold-off by time: 25 nsec to 20 sec.
 Hold-off by events: 1 to 10^9 events.
 No hold-off: = 12.5 nsec

c) Triggering at the beginning or end of a pattern if the time since the last pattern or of the pattern itself is < or > a specified value.

Select **Width Type** and set it to **Pattern Width**. Use button (36) to select **Width <** or **Width >** as required. Set the width using the **Adjust** knob (37).

Range: Pattern width <: 2.5 nsec to 20 sec.
 Pattern width >: 2.5 nsec to 20 sec.

Note: The separation between the leading edges of two consecutive pulses should be greater than 10 nsec to correctly

measure the width. If this condition is not satisfied, the width measurement can be affected by a maximum error of 10 nsec.

- d) Triggering at the beginning or end of a pattern if the time since the previous transition of this type is < or > a specified value.

Select **Width Type** and set it to **Interval Width**. Use button (36) to select **Width <** or **Width >** as required. Set the width using the **Adjust knob** (37).

Range: Interval width <: 10 nsec to 20 sec.
Interval width >: 25 nsec to 20 sec.

Bi-level

This is a variation of pattern trigger enabling the oscilloscope to trigger on any signal (connected simultaneously to two trigger channels) that exceeds a preset high or low trigger level. The third channel must be set to don't care. This is also known as a window trigger since the 9420/50 will trigger whenever the signal leaves the allowed region. In the following this will be known as a transition. This mode allows the oscilloscope to trigger when a transition occurs regardless of whether the slope is positive or negative.

Adjusting The Bi-level Trigger

- 1) Use a T-connector to connect the same signal to Channel 1 and 2 (or Channel 1 and External, or Channel 2 and External).
- 2) Ensure that cables connected to Channels 1 and 2 are the same length. This is very important as the signals must arrive at both inputs at exactly the same time.
- 3) Set the trigger **Level**, **Delay**, and **Coupling** as required. These parameters can be set before or after entering the SMART trigger menu. However, they must be set when the SMART trigger is OFF.

Note: In this example it is crucial that the trigger level of Channel 1 be lower than the trigger level of Channel 2. The best way to verify this is by looking at the real signal.

- 4) Ensure that the SMART trigger is switched ON. (The LED beside button (35) should be lit.)
- 5) Press **Modify SMART Trig** in the Panel Status menu to enter the SMART trigger menu.
- 6) Use buttons (2) and (3) or the **Reference** button to select **Trigger Type**.
- 7) Use buttons (4) and (5) or the **Difference** button to set **Trigger Type** to **Pattern**.

- 8) Use the **Reference** and **Difference** buttons to select and set Channel 1 to high (**H**), Channel 2 to low (**L**) and External to don't care (**X**).
- 9) Select **Pattern State** and set it to **exited**.
- 10) There are now some further options:
 - a) Triggering on any transition with no hold-off.

Select **Value** using button (39).

Use button (36) to select **Time** or **Events** and then press the **Zero** button.
 - b) Triggering on a transition followed by a hold-off by time or events.

Select **Value** using button (39).

Use button (36) to select **Time** or **Events** and use the **Adjust** knob (37) to set the hold-off as required.

Range: Hold-off by time: 25 nsec to 20 sec.
 Hold-off by events: 1 to 10⁹ events.
 No hold-off: i.e. 12.5 nsec
 - c) Triggering on a transition if the time since the signal transition is < or > a specified value.

Select **Width Type** and set it to **Pattern Width**.

Select **Value** using button (39).

Use button (36) to select **Width <** or **Width >** as required. Set the width using the **Adjust** knob (37).

Range: Pattern width <: 2.5 nsec to 20 sec.
 Pattern width >: 2.5 nsec to 20 sec.

Note: The separation between two consecutive transitions should be greater than 10 nsec in order to have a correct measurement of the width. If this condition is not satisfied, the width measurement can be affected by a maximum error of 10 nsec.
 - d) Triggering on a transition if the time since the previous transition is < or > a specified value.

Select **Width Type** and set it to **Interval Width**.

Select **Value** using button (39).

Use button (36) to select **Width <** or **Width >** as required. Set the width using the **adjust** knob (37).

Range: Interval width <: 10 nsec to 20 sec.
 Interval width >: 25 nsec to 20 sec.

Adjustments

- 1) Set the trigger Level, Delay, Coupling, and Slope as required. These parameters can be set before or after entering the SMART trigger menu. However they should be set when the SMART trigger is OFF.
- 2) Ensure that the SMART trigger is switched ON. (The LED beside button (35) should be lit.)
- 3) Press **Modify SMART Trig** in the Panel Status menu to enter the SMART trigger menu.
- 4) Use buttons (2) and (3) or the **Reference** button to select **Trigger Type**.
- 5) Use buttons (4) and (5) or the **Difference** button to set **Trigger Type** to **State Qualified**. Figure 57 indicates a typical state-qualified trigger configuration.

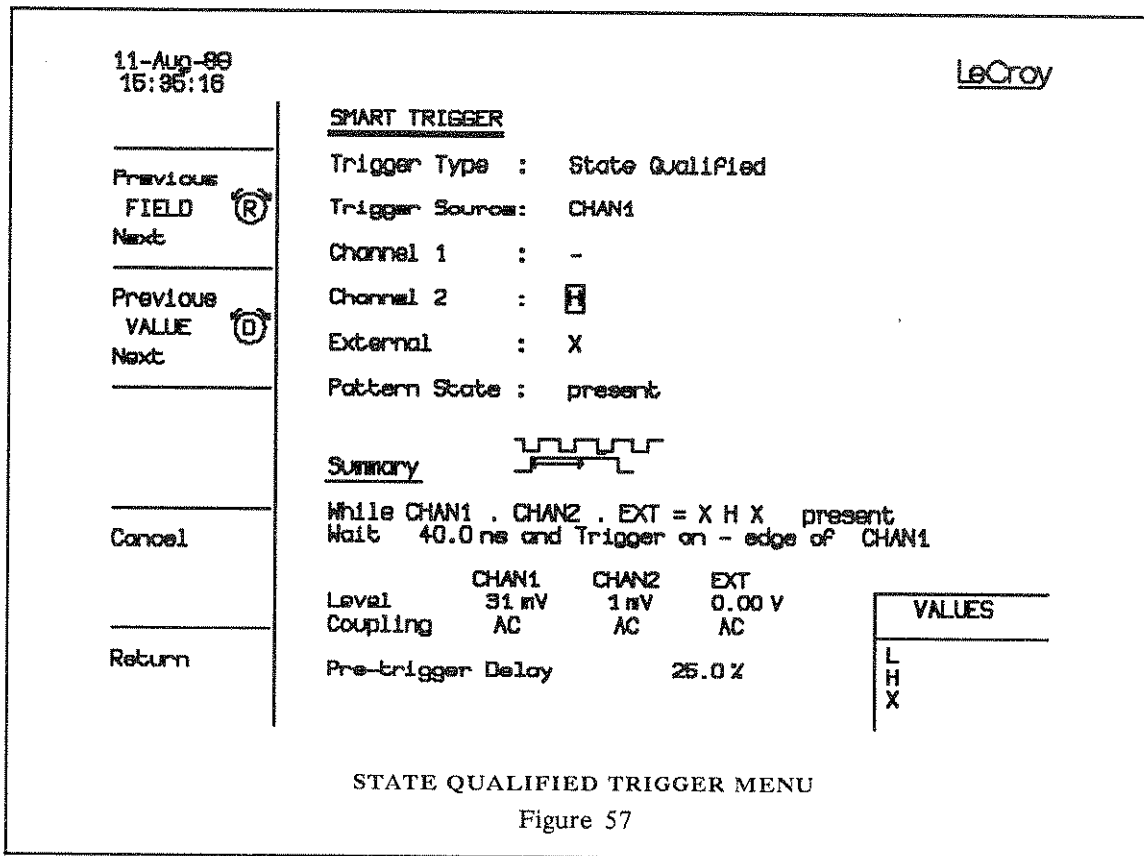

To configure the state-qualified trigger the following parameters must be set:

- * The trigger source, **CHAN1**, **CHAN2**, **LINE** or **EXT**.
 - * The required logic pattern of Channel 1, Channel 2 and External.
 - * Whether the 9420/50 should trigger when the pattern is absent or present.
 - * Other conditions, i.e. a hold-off by time or events.
- 6) Use the **Reference** and **Difference** buttons to select **Trigger Source** and set it to **CHAN1**, **CHAN2**, **LINE** or **EXT** as required.
 - 7) Select each of the remaining sources and set them to the required logic states, **H**, **L** or **X**.
 - 8) Select **Pattern State** and set it to **absent** or **present** as required.
 - 9) There are now some further options:

- a) Triggering without a wait.

Select **Value** using button (39).

Use button (36) to select **Time** or **Events** and then press the **Zero** button (38).

In this case the 9450 will trigger on the first source event with the required logic pattern. It will not require a transition of the pattern.

- b) Triggering when a certain pattern of two trigger sources is present or absent followed by a delay by time or events.

Note: A transition from pattern invalid to pattern valid is necessary to start the delay (if it is not set to zero).

Select **Value** using button (39).

Use button (36) to select **Time** or **Events** and use the **Adjust** knob (37) to set the delay as required.

Range:	Wait by time:	20 nsec to 20 sec.
	Wait by events:	3 to 10 ⁹ events.

Time/Event Qualified Trigger

The oscilloscope triggers on any source as soon as a certain pattern of the three channels is entered or exited. From the moment of validity of the pattern, a delay can be defined in terms of time or number of trigger events. Note that the delay follows a trigger and is not restarted by every transition of the pattern. A schematic drawing of the time/events qualified trigger is given in Figure 58.

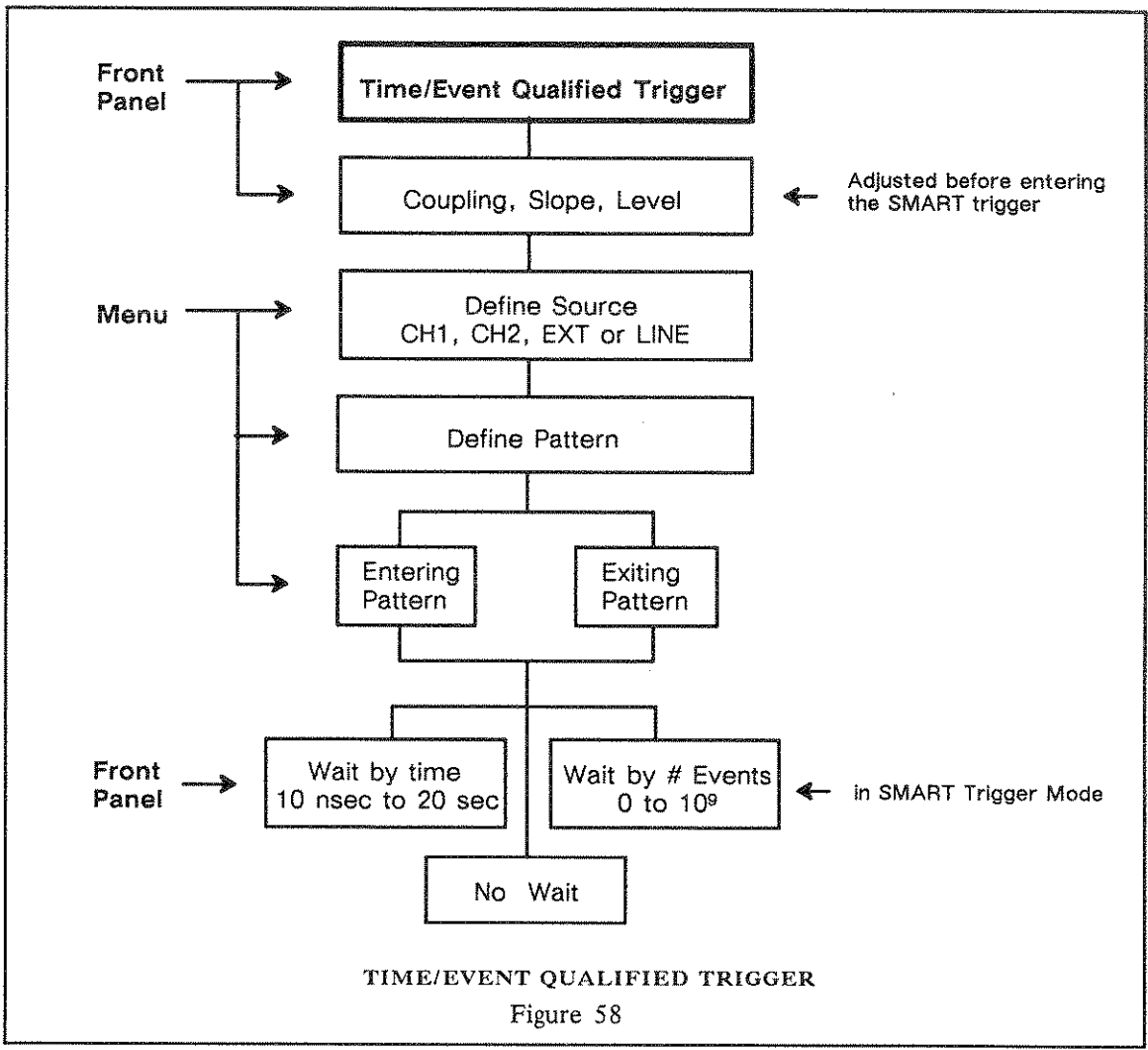

7 *The Smart Trigger*

Adjustments

- 1) Set the trigger **Level**, **Delay**, and **Slope** as required. These parameters can be set before or after entering the SMART trigger menu. However they should be set when the SMART trigger is OFF.
- 2) Ensure that the SMART trigger is switched ON. (The LED beside button (35) should be lit.)
- 3) Press **Modify SMART Trig** in the Panel Status menu to enter the SMART trigger menu.
- 4) Use buttons (2) and (3) or the **Reference** button to select **Trigger Type**.
- 5) Use buttons (4) and (5) or the **Difference** button to set **Trigger Type** to **Time/events Qualified**.
- 6) Use the **Reference** and **Difference** buttons to select **Trigger Source** and set it to **CHAN1**, **CHAN2**, **LINE** or **EXT** as required.
- 7) Set the pattern trigger sources to the required logic states, **H**, **L** or **X**.
- 8) Select **Pattern State** and set it to **entered** or **exited** as required. A typical time/events qualified trigger configuration is shown in Figure 59.

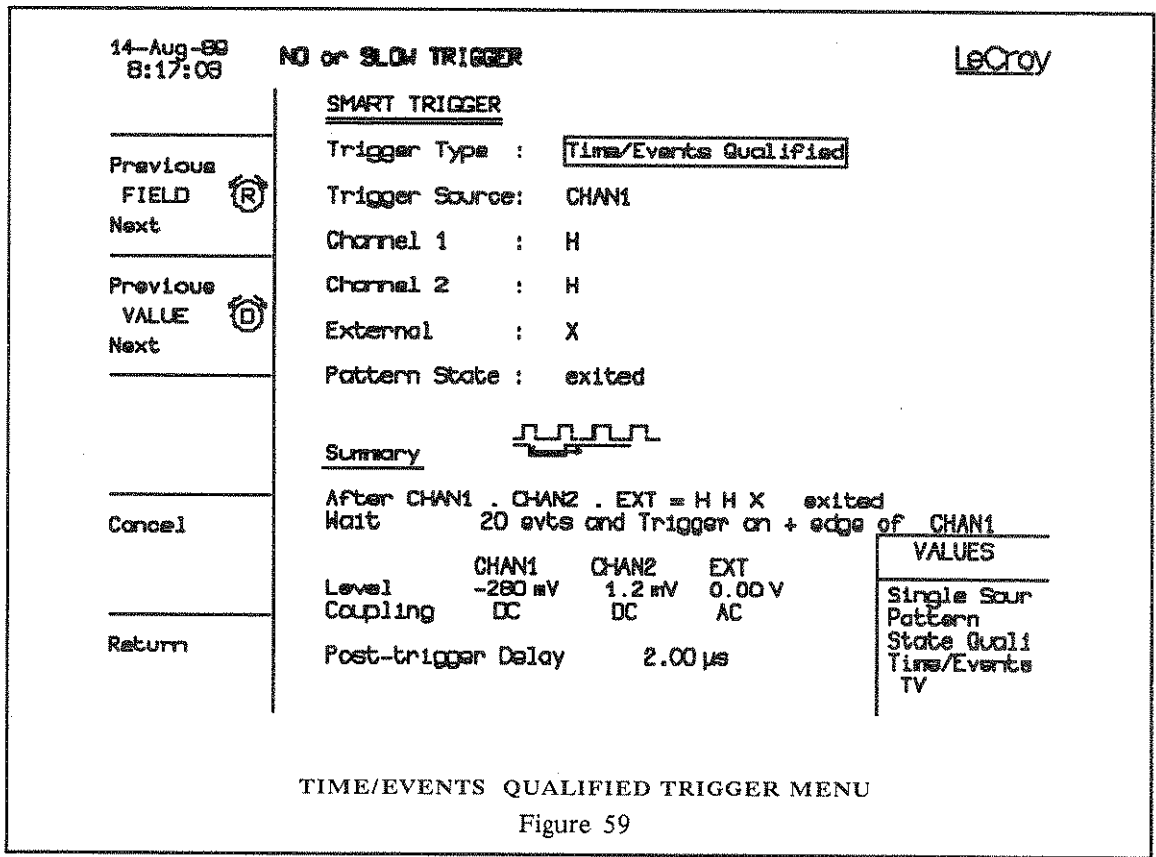

To configure the time/events qualified trigger the following parameters must be set:

- * The trigger source, CHAN1, CHAN2, LINE or EXT.
- * The required logic pattern of the sources Channel 1, Channel 2, and External.
- * Whether the oscilloscope should trigger when the pattern is entered or exited.
- * Other conditions, i.e. a wait by time or events.

9) There are now some further options:

a) Triggering without a wait.

Select Value using button (39).

Use button (36) to select Time or Events and then press

the **Zero** button.

Note: A transition from pattern invalid to pattern valid is always necessary.

- b) Triggering on a chosen source as soon as a certain pattern of the three sources is entered or exited and a delay by time or events.

Select **Value** using button (39).

Use button (36) to select **Time** or **Events** and use the **Adjust** knob (37) to set the wait as required.

Range: Wait by time: 10 nsec to 20 sec.
 Wait by events: 0 to 10⁹ events.

TV trigger

The oscilloscope triggers on the beginning of the chosen line of a composite video signal on the EXT trigger input. A schematic drawing of the TV trigger is shown in Figure 60.

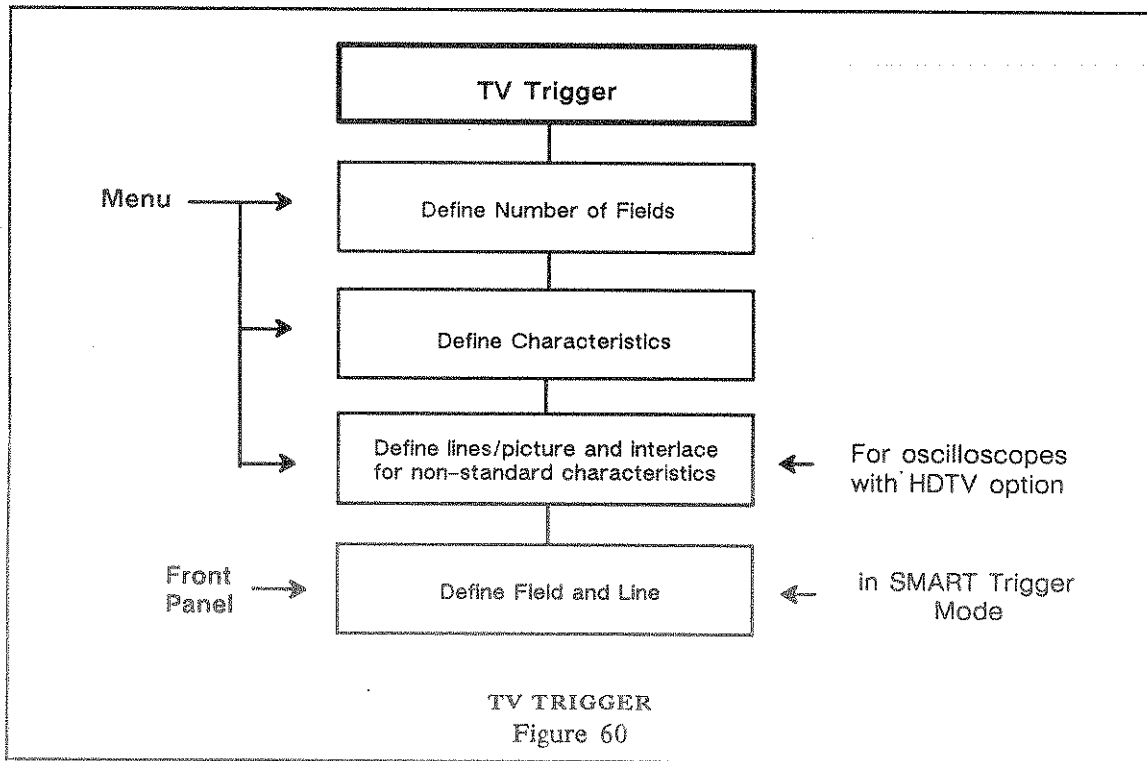

Adjusting the TV trigger

- 1) Ensure that the SMART trigger is switched ON. (The LED beside button (35) should be lit.)
- 2) Press **Modify SMART Trig** in the Panel Status menu to enter the SMART trigger menu.
- 3) Use buttons (2) and (3) or the **Reference** button to select **Trigger Type**.
- 4) Use buttons (4) and (5) or the **Difference** button to set **Trigger Type** to **TV**.
- 5) Use buttons (2), (3), (4) and (5) to set the required **Number of Fields**.
- 6) Use buttons (2), (3), (4) and (5) to set the required **Characteristics**.
- 7) For non-standard characteristics, select the **Lines/picture and Interlace**.

Figure 61 shows a typical TV trigger configuration.

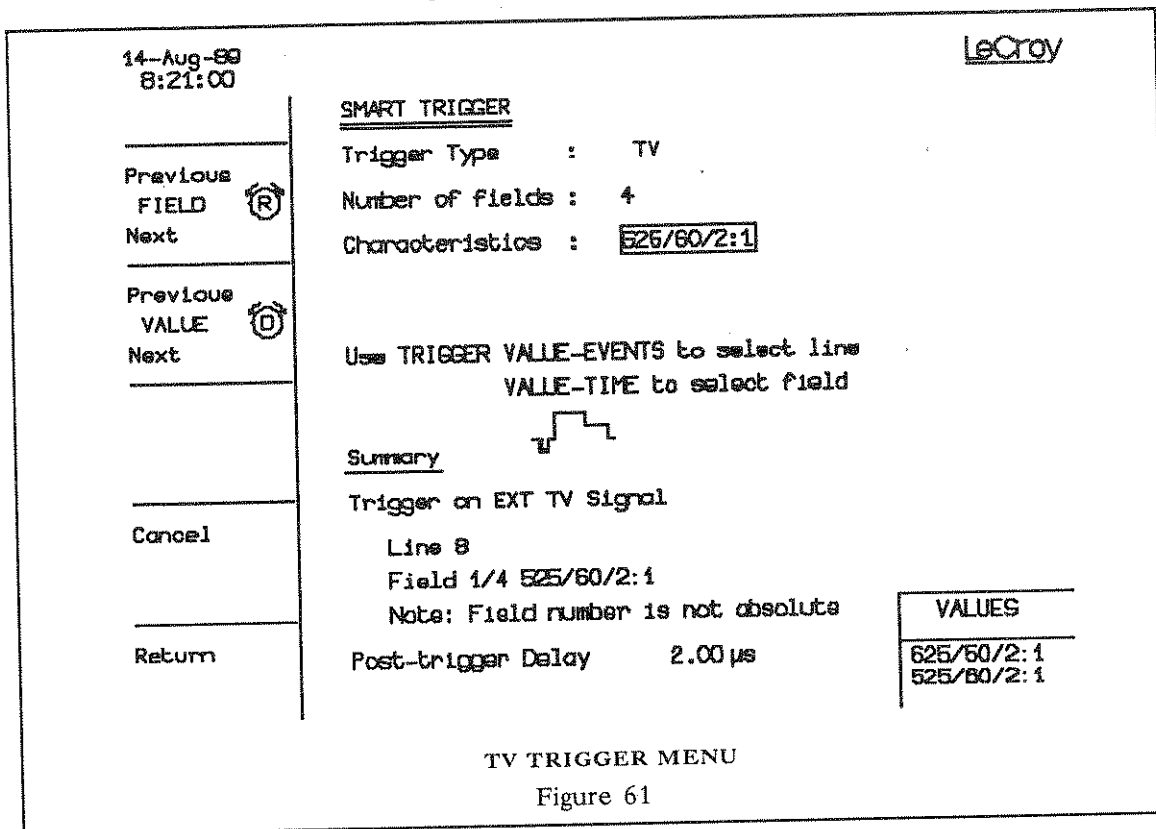

- 8) There are now some further options:
- a. Triggering on any line
Select **Value** using button (39).
Use button (36) to select **Events** and then press the **Zero** button (38).
 - b. Triggering on a particular line
Select **Value** using button (39).
Use button (36) to select **Events** and then the **Adjust** knob (37) to select the line.
 - c. Triggering on a particular field
Select **Value** using button (39).
Use button (36) to select **Time** and then the **Adjust** knob (37) to select the field.

Notes

A. The enhanced field-counting capability (**FIELDLOCK**) allows the oscilloscope to trigger consistently on a chosen line within a chosen field of the signal. Most TV systems have more than two fields. For example, with the number of fields set to 8 on the oscilloscope, the required line is triggered on and the user can examine all of its characteristics in a reproducible way. It should be noted that the field numbering system is relative in that the oscilloscope cannot distinguish between lines 1, 3, 5, and 7 (or 2, 4, 6, and 8) in an absolute way. Once the oscilloscope has started to trigger on a particular line of a particular field, changes of field or line are treated in the usual manner. However, it is up to the user to determine the absolute numbering of the chosen field if necessary. A warning message will be displayed if the instrument is forced to restart its field synchronization procedure. (This message is often an indication of incorrect parameters in the TV trigger setup menu.)

B. For each of the characteristics the following remarks apply:

- 1) 625/50/2:1 (European style PAL and SECAM systems)

This setting should be used for most of the standard 50 field/sec signals. The lines may be selected in the range 1 to 626 where line 626 is identical to line 1. The lines are numbered in the standard way. The required field and number of fields must be set appropriately in order to select lines with numbers above 313.

Number of fields = 8 should be very useful for color PAL signals. Number of fields = 4 is appropriate for SECAM signals.

2) 525/60/2:1 (American style NTSC systems)

This setting should be used for standard 60 field/sec NTSC signals. The lines are selectable in the range 1 to 1050. The lines are numbered in the standard way. The desired field and number of fields must be set appropriately in order to select lines with numbers above 262 or 525.

Number of fields = 4 should be very useful for American-style NTSC systems.

3) ?/50/?, ?/60/?

In order to allow maximum flexibility, no line-counting convention is used. The line count should be thought of as a line-synchronizing pulse count, and it includes the transitions of the equalizing pulses. For certain extreme cases of TV signals, the field transition recognition will no longer work. In this case, only the "any line" mode will be available.

C. The enhanced field-counting capability cannot be used for RIS acquisitions.

D. Composite video signals must have negative-going synch to be decoded correctly.

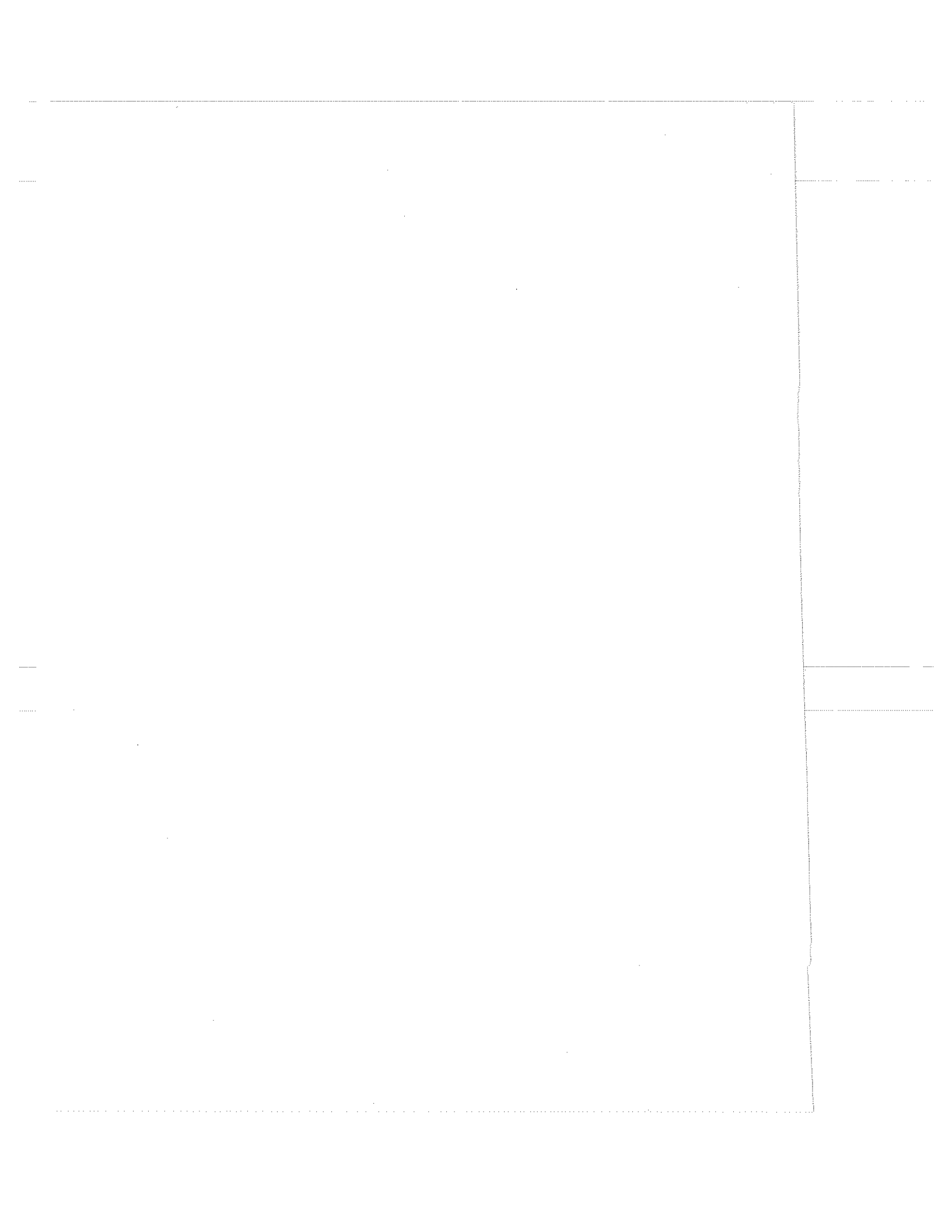

MAINS VOLTAGE SELECTION (60)

Ensure that the mains voltage for your area corresponds to the mains voltage set on the 9420/50, i.e. the green peg on the **Voltage Selector plate (60)** should be set to 115 V or 220 V as required. To adapt the oscilloscope to the other voltage, first remove the power cable and unscrew the **Voltage Selector plate**.

Pull the green voltage board out of its socket using a pair of flat pliers. Shift the board left (for 115 V) or right (for 220 V) by two contacts and plug it back into its socket. Screw the **Voltage Selector plate** back into position. The green peg should now be next to the required voltage value.

FUSE PROTECTION

The power supply of the 9420/50 is protected against short circuits and overload by means of two T(slow) 3.15 A/250 V fuses. The fuses are located beside the mains plug.

Remove the power cable before changing or inspecting a fuse. Open the fuse box with a small screwdriver by inserting it under the plastic cover from the right-hand side (just next to the mains connector) and prying it open.

Each fuse is retained by an individual fuse holder. To take a fuse holder out, release the retaining latch using the screwdriver, pushing up for the upper holder or down for the lower holder. Slide the holder with its fuse out.

The fuse and its holder are replaced by simply inserting them back into the corresponding hole until they are latched into place. They can be inserted only if the retaining latch points toward the center between the two fuses. Latch the fuse box cover securely into place.

POWER SWITCH (59)

Power for the operation of the instrument is interrupted or established with the **Power switch (59)**. The power is ON when the switch is pressed in, and OFF when the switch is not pressed in.

ACCESSORY POWER CONNECTORS (66)

Two LEMO RA 0304 NYL connectors have been provided to permit use of FET type probes with the 9420/50. These connectors provide output voltages of + 5 V, ± 15 V and GND connection and are suitable for most FET probes.

The maximum output current per connector must be limited to 150 mA for each of the three voltages.

GPIB AND RS-232-C PORT SELECTION (63)

The oscilloscope's rear-panel thumbwheel switches are used to set addresses for programmed or remote oscilloscope operation. Addresses 0-30 define the 9420/50's address when using the GPIB (IEEE-488) port. Any one of the addresses 31-99 selects the RS-232-C port.

Note: The address set on the thumbwheel switch is read by the processor when the 9420/50 is powered up. This is the address which appears in the Auxiliary Setups menu. Each time the address is changed, the oscilloscope should be switched off and on again.

RS-232-C CONNECTOR (61)

The RS-232-C port (61) can be used for remote oscilloscope operation, as well as for direct interfacing of the 9420/50 to a digital plotter or printer to produce hard copies of displayed waveforms and other screen data.

While a plotter unit is connected to the 9420/50, its RS-232-C port can be computer controlled from a host computer via the GPIB port. The oscilloscope's built-in digital plotter and printer drivers enable hard copies to be made without an external computer.

RS-232-C connector pin assignments:

Pin #	Description
2	T x D Transmitted Data (from the 9420/50)
3	R x D Received Data (to the 9420/50)
4	RTS Request To Send (always on) (from the 9420/50)
5	CTS Clear To Send (to the 9420/50) When TRUE, the 9420/50 can transmit. When FALSE, transmission stops. Used for 9420/50 output hardware hand shake.
20	DTR Data Terminal Ready (from the 9420/50) Always TRUE.
6	DSR Data Set Ready (to the 9420/50)
1	GND Protective Ground
7	SIG GND Signal Ground

This corresponds to a DTE (Data Terminal Equipment) configuration.

ACCESSORY CONTROL (62)

This connector is used for factory testing the instrument.

BNC CONNECTORS

Four BNC connectors are available on the rear panel of the oscilloscope:

External CK input (55)

Sampling CK output (56)

Trigger out (57)

Trigger veto (58)

EXTERNAL CK INPUT

The external clock input allows waveforms to be sampled with a user-defined clock when the oscilloscope is in the "External Clock" mode.

It is a DC-coupled 50 Ω impedance input. The maximum input frequency is 100 MHz for the 9420 and 400 MHz for the 9450. The recommended input signal is symmetrical around 0 V with an amplitude of ± 400 mV peak (max. ± 1 V peak). The risetimes and falltimes must be less than 10 nsec.

SAMPLING CK OUTPUT

The sampling clock output delivers a continuous signal at half the sampling frequency. During acquisition the signal is sampled at each transition of this signal. The output should be terminated on 50 Ω to GND. This is a DC coupled, high impedance output which generates 0 mA for logic "0" state and - 16 mA for logic "1" state corresponding to 0 mV and - 800 mV respectively on a 50 Ω load. The output amplitude is limited to - 1.4 V for all other loads.

The risetime and falltime are less than 1.5 nsec.

TRIGGER OUT

A negative pulse of variable width is generated when a trigger is accepted. This output should be terminated on 50 Ω to GND. The signal amplitude is 0 mV when quiescent and - 16 mA after a trigger has been accepted (or - 800 mV into 50 Ω).

TRIGGER VETO

The trigger veto input/output can be used to synchronize the acquisition of several 9420/50s. It should be connected to a 50 Ω cable terminated at each end by 50 Ω to GND.

The output, at a high state when the 9420/50 is ready for a trigger, goes negative when the instrument is busy, disabling all the oscilloscopes connected to the same veto line. If this line is changed from low to high via external control, all the oscilloscopes connected to the veto line are simultaneously enabled.

8 *The Rear Panel*

The trigger veto is DC-coupled, high impedance. It generates 2 mA when a trigger can be accepted and -16 mA when the 9420/50 is busy, that is 50 mV and -400 mV respectively on a 25 Ω load.

The amplitude of the signal is limited to ± 1.4 V. The risetime and falltime are less than 3 nsec.

Disabling actions for levels between -300 mV and -1.4 V; ineffective for levels between -100 mV and +1.4 V.

RESET (64)

This button is activated by pressing it with a small screwdriver or a similar tool, and keeping it pressed in until a buzz sounds.

A reset is only needed if a catastrophic failure of the instrument's software occurs. In many cases, it is sufficient to turn off the power and turn it on again.

The **Reset** button not only reboots the instrument (exactly as in the power-up sequence) but also clears the internal non-volatile RAM. Thus, stored front-panel setups and traces are lost.

The purpose of this section is to help the user make basic measurements using the 9420/50 and to provide a concise overview of the wide range of measurement capabilities offered by the LeCroy 9420 and 9450 oscilloscopes. While you may already be familiar with traditional oscilloscope operation, this outline will help to acquaint you with the many powerful features of these oscilloscopes.

In the following section we have sometimes chosen to set all acquisition parameters from the Panel Status menu; however, it is not necessary to be in this menu to change the front-panel settings. In most cases, the Abridged Front-panel Status field (VII) will provide all the necessary information.

WAVEFORM ACQUISITION

Simple Measurements using the Probe Calibrator Signal

Switching on the 9420/50

- 1) Connect the oscilloscope to the mains using the cable provided.
- 2) Press the **Power** switch on the rear panel to switch the oscilloscope on. Notice that when the instrument is switched on, the 9420/50 is in the root menu, i.e. the Menu field (II) is blank apart from the option **Main Menu** next to button (2).

Example 1: Auto-setup

Connecting the Probe Calibrator Signal

- 1) Connect the P9020 probe connector to **Channel 1** input (25).
- 2) Connect the probe's grounding clip to lug (23) and touch the tip to lug (22).
- 3) Set the **Channel 1 Coupling** to **AC 1 M Ω** or **DC 1 M Ω** .
- 4) Set **Channel 1** trace to **ON** and switch all the other traces off, buttons (50) to (53).

Auto-setup

- 5) Press **Auto-setup**, button (21). The **Auto-setup** button automatically scales the time-base, trigger and sensitivity settings to provide a stable display.

Auto-setup

You can use the auto-setup facility for repetitive signals if:

- $2 \text{ mV} < \text{amplitude} < 8 \text{ V}$
- Frequency $> 50 \text{ Hz}$
- Duty cycle $> 0.1\%$

Example 2: Manual Setup

We will now repeat the same recording of the probe calibrator signal except that this time the oscilloscope will be set manually.

Connecting the signal

- 1) Connect the P9020 probe connector to the **Channel 1** input (25).
- 2) Connect the probe's grounding clip to lug (23) and touch the tip to lug (22).

Selecting a channel

- 3) Use buttons (50) to (53) to set **Channel 1** on and all the other traces off.
- 4) Use the **Mode** button (28) to set the oscilloscope to **Single** and **Status Trig'd**.
- 5) Set Channel 1 **Coupling** to **DC 1 M Ω** (24).

Entering the Panel Status menu

- 6) The 9420/50 is in the root menu when it has just been switched on. Press **Main Menu**, button (2).
- 7) Press **Panel Status**, button (2).

Adjusting the vertical parameters

- 8) Set Channel 1 **Fixed V/Div** to 10 mV/div (29).
- 9) Adjust the Channel 1 vernier (30) to get a **Total V/div** of 13.0 mV.
- 10) Set Channel 1 **Offset** to -50 mV (34).
- 11) Set **BW Limit** to OFF (54).

Setting the time base

- 12) Set **Time/Division** control (41) to 0.5 msec. Note that at this time-base setting, **Interleaved Sampling (RIS)** is OFF.

Adjusting the trigger

- 13) Select **Trigger Delay** using button (39). Adjust the pretrigger delay to 20.0% using the **Adjust** knob (37).
- 14) Select **Trigger Level** using button (39). Adjust the trigger level to 0 mV using the **Adjust** knob (37) or the **Zero** button (38).
- 15) Set the **Trigger Coupling** to **AC** (32).
- 16) Set the **Trigger Source** to **CHAN 1** (26).
- 17) Set the **Trigger Slope** to **POS** (31).
- 18) Set the **Trigger Mode** to **AUTO** (28).

Miscellaneous

- 19) Return to the **Main Menu** by pressing the **Return** button (10).
- 20) Set **Dual Grid** mode to **OFF** (14).

The resulting display is shown in Figure 62.

9 Getting Started

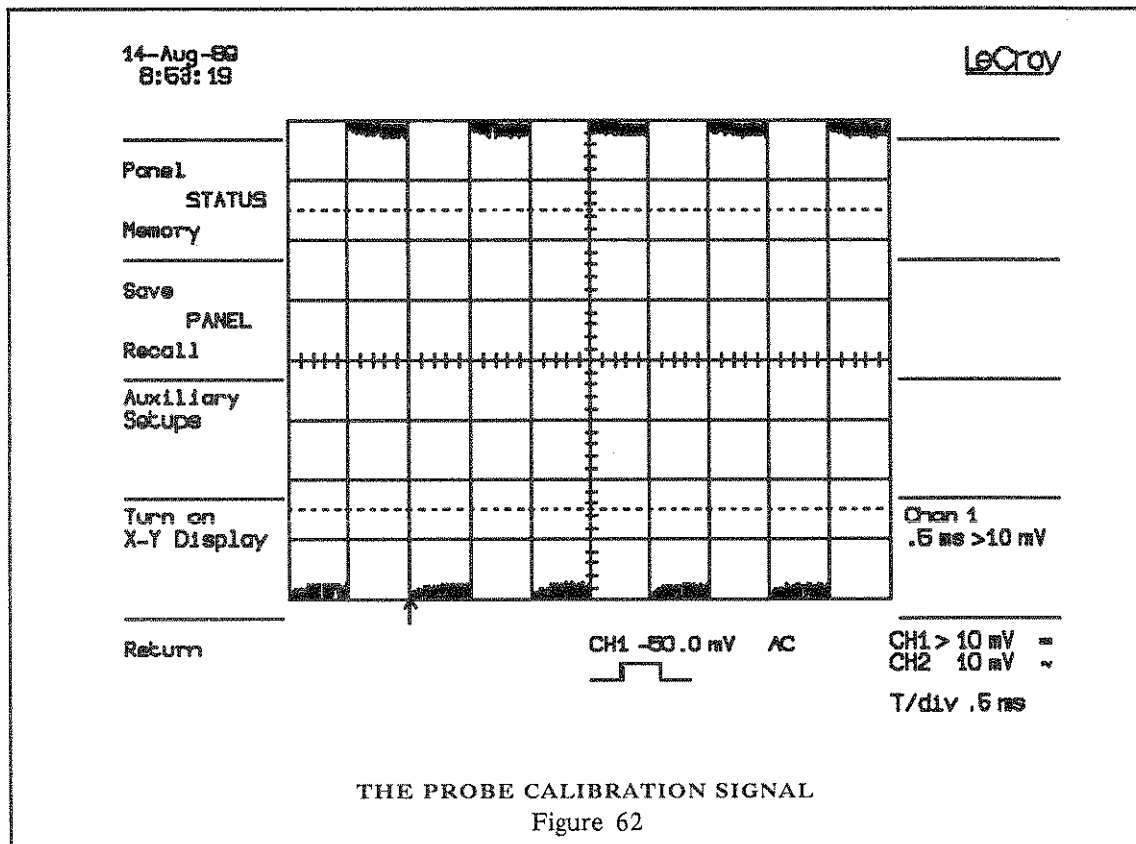

The Dual Grid

Dual grid makes the screen very easy to read when you have several traces:

Channel 1 is always in the upper grid

Channel 2 is always in the lower grid

Use the Select button and the Vertical Position knob to place any other traces in the most convenient grid.

**Example 3: How to Check
the Probe Calibrator**

The P9020 probe has a $\times 10$ attenuation factor. Thus, the 1 V, 1 kHz output calibration signal is displayed with a total amplitude of approximately 7.7 divisions at a **Total V/div** setting of 130 mV. If there is over- or under-shoot, adjust the probe compensation trimmer, located on the barrel of the P9020, for a clean square wave contour. For further adjustments of the probe, consult the probe manual.

Signal Acquisition Summary

Connect the signal
Select an acquisition channel
(Enter the Panel Status menu)
Adjust the vertical parameters
Adjust the time base
Adjust the trigger
(Miscellaneous)

or

(for repetitive waveforms only)

Connect the signal
Select the signal coupling
Select a channel
Press Auto-setup
Adjust

Below are some further examples of setting up the 9420/50 for various types of signals.

**Example 4:
Random Interleaved Sampling
for Fast Repetitive Signals
(Period 10 to 100 nsec)****Connecting the signal**

- 1) Connect a fast pulse generator providing an output signal whose period is between 10 and 100 nsec (i.e. frequency between 10 and 100 MHz) to the **Channel 2 BNC input (25)**.

Selecting a channel

- 2) Set **Channel 2** on and all other traces off, buttons (50) to (53).
- 3) Set **Channel 2 Coupling** to **DC 50 Ω** (24).
- 4) Press **Auto-setup** (21).
- 5) Set **Bandwidth Limit** to **OFF** (54).

Adjusting the time base

- 6) Set the **Time/Division** control (41) to 20 nsec/div . Notice that at this setting **Interleaved Sampling (RIS)** is **ON**.

Adjusting the trigger

- 7) Select **Trigger Delay** using button (39). Use the **Adjust knob** (37) to set the pretrigger delay so that the vertical arrow is four divisions to the right of the lower left edge of the grid.

Miscellaneous

- 8) Set **Dual Grid** mode to **OFF** (14).

A typical display is shown in Figure 63.

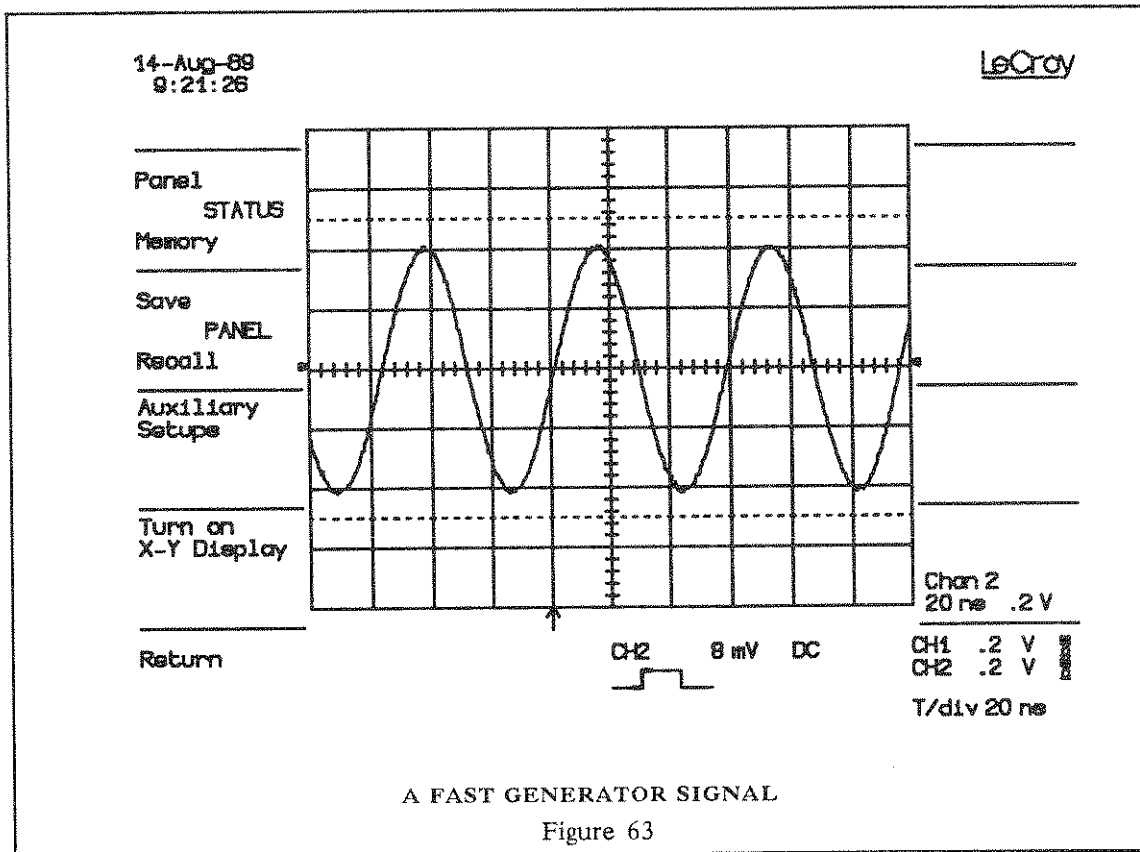

**Example 5:
Single-shot Acquisitions
(Pulse 100 nsec Wide)**

Connecting the signal

- 1) Connect the signal from a pulse generator to the Channel 1 BNC input (25). The pulse generator should be free-running during the initial setting up of the 9420/50. It must be set to provide a pulse 100 nsec wide with an amplitude of your choice.

Selecting an acquisition channel

- 2) Set Channel 1 to ON and all the other traces off (50) to (53).
- 3) Set Channel 1 COUpling to 50 Ω DC (24).

Entering the Panel Status Menu

- 4) In the main menu press **Panel Status**, button (2).

Adjusting the voltage sensitivity

- 5) Set Channel 1 **Fixed V/Div** as appropriate (29), i.e. to match the generator signal amplitude.
- 6) Adjust the Channel 1 **VAR** vernier (30) if necessary to match the generator.

Adjusting the time base

- 7) Set the **Time/Division** control (41) to 20 nsec/div.
- 8) Set **Interleaved Sampling** to OFF (40).

Adjusting the trigger

- 9) Select **Trigger Delay** using button (39). Set the pre-trigger delay to 10% using the **Adjust** knob (37).
- 10) Select **Trigger Level** using button (39). Set the trigger level to an appropriate level using the **Adjust** knob (37).
- 11) Set the **Trigger Coupling** to AC (32).
- 12) Set **Trigger Source** to CHAN1 (26).
- 13) Set **Trigger Slope** to POS (31).
- 14) Arm the trigger by setting the **Trigger Mode** (28) to **Single**.

Miscellaneous

- 15) Set the Channel 1 **Offset** to suit the input signal (34).
- 16) Set the **Bandwidth Limit** to OFF (54).
- 17) Return to the Main Menu by pressing the **Return** button (10).
- 18) Set **Dual Grid** mode to OFF (14).
- 19) When you see the signal on the screen put the generator in external or manual trigger so that it is no longer free-running. Set **Trigger Mode** (28) to **Single** on the oscilloscope and trigger the signal source.

A typical display is shown in Figure 64.

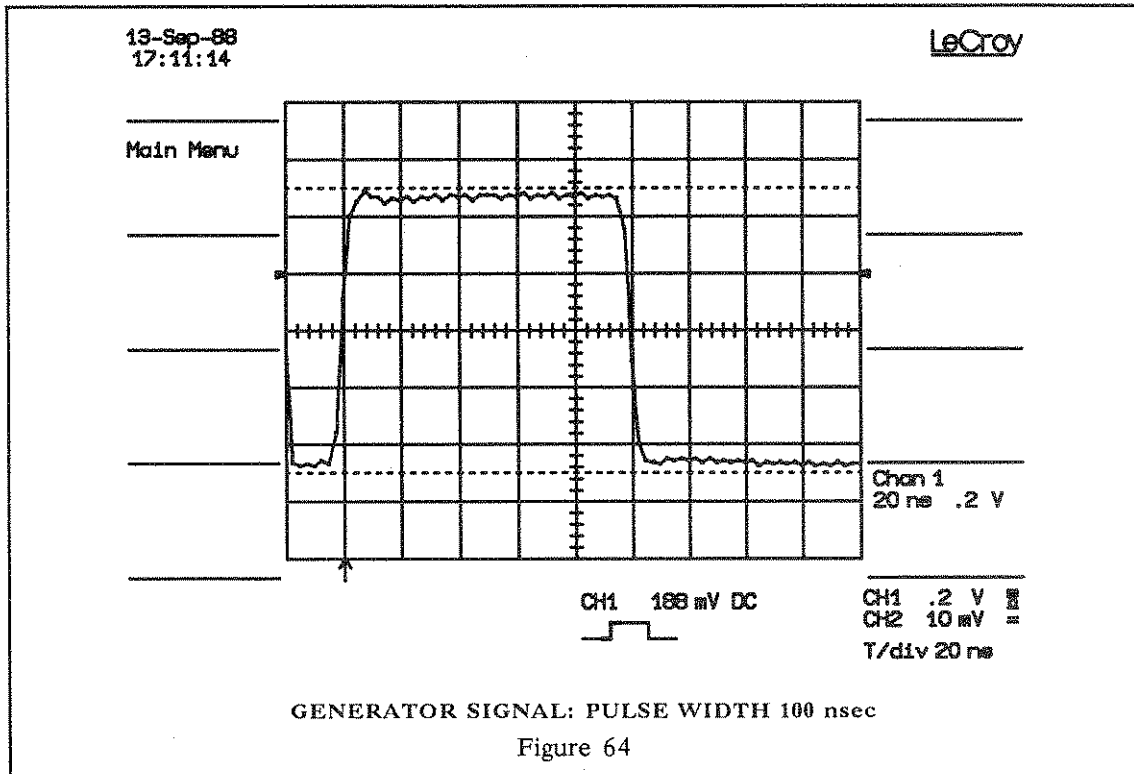

Example 6:
Roll Mode for Slow Signals
 (1 Hz Sine Wave)

Connecting the signal

- 1) Connect a 1 Hz signal source to the **Channel 2** BNC input connector (25) with an amplitude and offset of your choice.

Select an acquisition channel

- 2) Switch **Channel 2** on and all the other traces off using buttons (50) to (53).
- 3) Set Channel 2 **Coupling** (24) to DC 1 M Ω .

Entering the Panel Status Menu

- 4) In the main menu press **Panel Status**, button (2).

Adjusting the voltage sensitivity

- 5) Set the Channel 2 voltage sensitivity to suit the signal (29).

Adjusting the time base

- 6) Set the Time Base to 1 sec/div (41).

Adjusting the trigger

- 7) Use button (39) to select **Trigger Delay**. Turn the **Adjust knob** (37) until the pretrigger delay is set to 50%.
- 8) Select **Trigger Level** using button (39). Use the **Adjust knob** (37) to set the trigger level to an appropriate level.
- 9) Set the **Trigger Slope** to **POS** (31).
- 10) Set the **Trigger Mode** to **NORM** (28).
- 11) Set the **Trigger Source** to **CHAN2** (26).

Miscellaneous

- 12) Adjust **Channel 2 Offset** to suit your signal (34).
- 13) Press **Return** button (10) to return to the Main Menu.
- 14) Set **Dual Grid mode** to **OFF** (14).

Resulting Display: A sine wave signal will be displayed, rolling from right to left across the screen. The display can be halted by pressing the **Single** button (28) when in **Norm** trigger mode. It also pauses at the end of an acquisition for which a trigger was received.

Example 7: Sequence Mode for Segmenting Memories into 5 Segments

Sequence mode is used for sequential recording of single events in segmented memory.

Connecting the signal

- 1) Connect the signal from a pulse generator to the **Channel 1 BNC input** (25). For the purpose of this exercise set the pulse generator so that it is free-running while you set up the oscilloscope. It must be set to provide a pulse around 200 nsec wide with an amplitude of your choice.

Selecting an acquisition channel

- 2) Switch **Channel 1** on and switch all the other traces off, using buttons (50) to (53).
- 3) Set **Channel 1 Coupling** to **DC 50 Ω** (24).

Entering the Panel Status Menu

- 4) In the main menu, press **Panel Status**, button (2).

Adjusting the voltage sensitivity

- 5) Set Channel 1 **Fixed V/Div** as appropriate (29), i.e. to match the generator signal amplitude.
- 6) Adjust Channel 1 **VAR** vernier (30) if necessary to match the generator.

Adjusting the time base

- 7) Set the **Time/Division** control (41) to 50 nsec/div.
- 8) Set **Interleaved Sampling** to Off (40).

Adjusting the trigger

- 9) Select **Trigger Delay** using button (39). Set the pretrigger delay to 20.0% using the **Adjust** knob (37).
- 10) Select **Trigger Level** using button (39). Set the trigger level to 0 V using the **Adjust** knob (37).
- 11) Set the **Trigger Coupling** to DC (32).
- 12) Set **Trigger Source** to CHANI (26).
- 13) Set **Trigger Slope** to POS (31).
- 14) Select **Seqnce** trigger mode (28).

Setting the required number of segments

- 15) Press **Modify # Segments** button (6) as often as necessary to display the value 5 in the **# Segments for Seqnce** line.

Miscellaneous

- 16) Set the Channel 1 **Offset** to suit the input signal (34).
- 17) Set the **Bandwidth Limit** to OFF (54).
- 18) Return to the Main Menu by pressing the **Return** button (10).
- 19) Set **Dual Grid** mode to ON (14).
- 20) When you see the signal on the screen, put the generator in external or manual trigger so that it is no longer free-running. Set the **Trigger Mode** (28) to **Seqnce** on the oscilloscope. Now actuate the generator's external trigger a total of 5 times to generate 5 signals to be recorded.

At this point a compacted trace of 5 segments is displayed in the upper grid. Trace expansions Expand A and Expand B may be used to display details of one or two selected segments. Waveform expansion is fully explained later in this chapter. The display resulting from this example is shown in Figure 65.

Sequence Mode for 10 Segments

To make a sequential recording of 10 single events, you need only modify the value displayed in the # Segments For Seqnce line of the Panel Status menu by pressing Modify # Segments button (6) until the value 10 appears in the # Segments For Seqnce line.

Keeping all other settings as above, generate 10 triggers. The resulting display, shown in Figure 66, shows the same waveform.

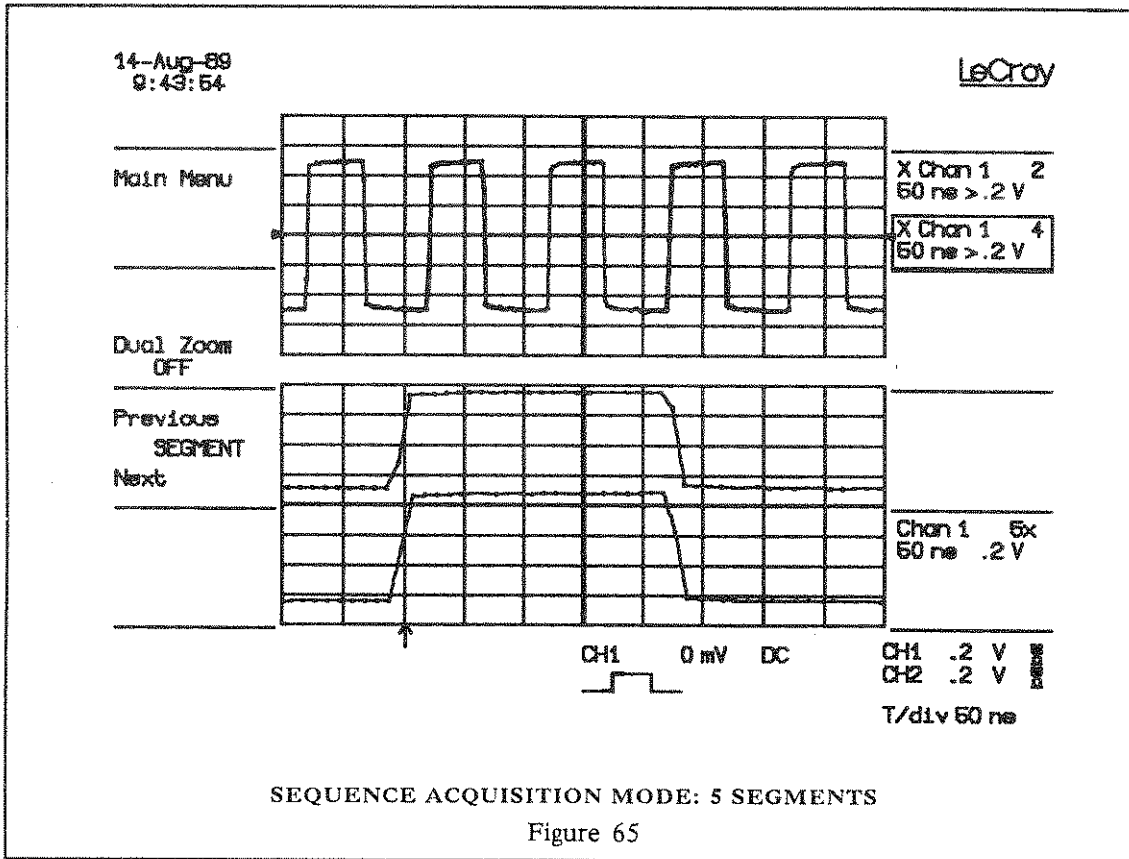

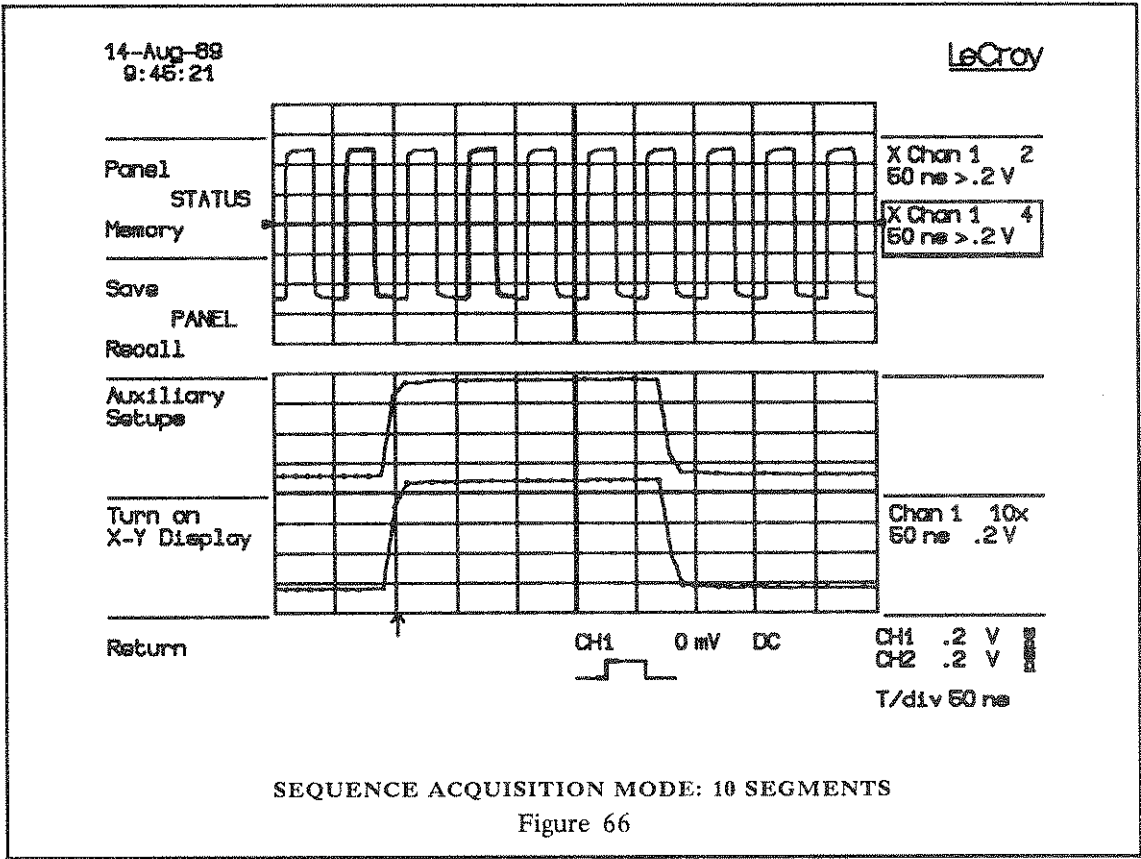

Sequence Acquisition Mode

Use sequence acquisition

- to capture multiple events
- when the dead time between successive events is short (minimum 100 μ sec)

SAVING AND RECALLING FRONT-PANEL SETUPS

Saving Front-panel Setups

Entering the Save menu

- 1) Choose a front-panel setup to save. You can, for example decide to save one of the front-panel setups used above.
- 2) Press **Main Menu**, button (2), in the root menu.
- 3) Press the **Save Panel** (4) button.

Saving the setup

- 4) At this point the listing of seven possible front-panel storage locations appears in the Menu field. Press the button adjacent to the storage location you would like to use, e.g. Panel 1. The complete front-panel settings are now stored.
- 5) Change some of the front-panel settings and follow the procedure outlined in steps 1 through 4 to store the new setup in Panel 2.

Recalling Front-panel Setups

Entering the Recall menu

- 1) Press **Main Menu**, button (2), in the root menu.
- 2) Press the **Recall Panel** (5) button.

Recalling the setup

- 3) At this point a list of the seven front-panel storage locations appears in the Menu field. The used locations are indicated with the word "from" followed by the date at which the front-panel setup was saved. The word "Empty" appears beside locations which have not yet been used.

Press button (2) which is adjacent to the Panel 1 storage location. The front-panel setup is now recalled.

- 4) Pressing button (3) in the **Recall Setup** menu will recall the second setup.

STORING AND RECALLING WAVEFORMS

Storing Waveforms

Example: Storing Chan 1 Into Memory C

Entering the Store Menu

- 1) Acquire a waveform on Channel 1 in the **Single** trigger mode.
- 2) Press **Store**, button (1), to call up the Store Trace menu.

Choosing a waveform to store

- 3) A new menu appears offering the possibility of storing any of the sources, **Exp A**, **Exp B**, **Func E**, **Func F**, **Chan 1** or **Chan 2**. Press button (6) which corresponds to **Chan 1**.

Storing the waveform

- 4) The 9420/50 offers you the choice of storing **Chan 1** into **Mem C** or **Mem D**. Press button (2) which corresponds to **Mem C**. You have now stored Channel 1 into Mmemory C.

Recalling Waveforms

Example: Recalling Memory C

- 1) Set **Memory C** to **ON**. The waveform you stored will appear on the screen. If Channel 1 is still on you will see only one waveform. To see both Channel 1 and Memory C turn the **Position** knob (44) slightly.
- 2) Recall **Memory D** in the same way.

The Store Trace menu also allows the user to store any other trace, including processed or expanded waveforms, into Memory C or D. The procedure outlined above enables two independent waveforms to be simultaneously stored and recalled for display. Calling the Memory Status menu (button (3) in the Main Menu) enables the user to inspect some of the parameters of the waveform.

The Panel Status and Memory Status displays

Panel Status:	Chan 1 and 2 only displays the acquisition parameters for the next acquisition
Memory Status:	All traces displays the parameters for traces already acquired and stored

Accessing the Memory Status Menu

- 1) In the Main menu, press **Memory Status** button (3). The Memory Status for the last trace inspected in the Memory Status menu is displayed.
- 2) You can read the Memory Status of any trace. There are two possibilities:
 - a) Use **Previous** and **Next Trace**, buttons (2) and (3).
 - b) Use the **Reference** knob (42).

WAVEFORM EXPANSION

Example 1: Expanding One Waveform (Expand A)

Acquiring a signal

- 1) Acquire a signal on Channel 1.
- 2) Set **Dual Grid**, button (14) to ON.

Choosing an Expand function

- 3) Press **Expand A** (50).

Choosing the waveform to expand

- 4) If the source for signal expansion shown in the **Displayed Trace** field (VIII) is not **X Chan 1**, you must perform the following procedure to redefine the expansion signal source as Channel 1.
 - a) Press the **Redefine** button (48) to display the **Redefine Source** menu in the **Menu** field (II).
 - b) Press button (6) to redefine Channel 1 as the new source for the expanded (**X Chan 1**) display.

Choosing a magnification factor

- 5) At this point the source for Expand A in the Displayed Trace field (VIII) is updated to **X Chan 1** and all or a portion of the Channel 1 trace is intensified.
- 6) Turn the **Time Magnifier** control (47) to adjust the magnification factor (length of the intensified section) to cover the area of interest.

Note that if you turn the **Time Magnifier** knob clockwise several times the signal will be expanded so much that interpolation between data points will occur. The actual data points will be highlighted and joined by straight lines.

Choosing a region of interest

- 7) Displace the intensified section by adjusting **Horizontal Position** control (43).

(Moving the expanded waveform)

- 8) You can position the expanded trace in lower grid by adjusting the **Vertical Position** control (44).

(Changing the Vertical Gain)

- 9) You can also adjust the **Vert Gain** control (46) to change the vertical magnification if required.

Example 2: Expanding a Second Region of a Waveform (Expand B)

To use Expand B follow the same procedure as above, except that in Step 3 the **Expand B** button (50) is pressed rather than the **Expand A** button. You will probably need to redefine the source of **Expand B**.

For independent control of Expand A and B, make sure that **Dual Zoom** mode is OFF. Press the return button (10) until the root menu is displayed and then press button (5) to switch the **Dual Zoom** mode OFF.

Summary: Expanding a waveform

Acquire a signal
Choose an Expand function
Choose the waveform to expand
Choose a magnification factor
Choose a region of interest
(Move the expanded waveform)
(Change the Vertical Gain)

Example 3: Dual Zoom on One Waveform

Acquiring signals

- 1) Use buttons (50) to (53) to switch Channel 1 on and all other traces off.
- 2) Acquire a signal on Channel 1.
- 3) Set **Dual Grid**, button (14) OFF.
- 4) Press the **Return** button (10) until the root menu is displayed (i.e. the only option available in the Menu field (II) is **Main Menu**).

Switching on the Expand functions

- 5) Switch **Expand A** and **Expand B** on (50). Notice two special features:
 - a) There is a highlighting frame around both expansions in the Displayed Trace field (VIII). One of the highlighting frames is made of dashed lines and the other of solid lines. The expansion function in the solid frame is the currently selected trace.
 - b) **Dual Zoom On** appears in the Menu field (II).

Note: If this is not the case, press button (5) to switch on the dual zoom expansion feature.

Choosing the waveforms to expand

- 6) If the sources for signal expansion shown in the Displayed Trace field (VIII) are not **X Chan 1** and **X Chan 1**, redefine the expansion signal sources to Channel 1 and Channel 1 using the redefine button as follows:

- a) Use **Select**, button (49), to place the solid highlighting frame around the expansion function which is not set as you require.
- b) Press the **Redefine** button (48) to display the **Redefine Source** menu in the **Menu** field (II).
- c) Press the button corresponding to the required source for the expansion.

Choosing a magnification factor

- 7) At this point the sources for **Expand A** and **Expand B** are shown in the **Displayed Trace** field (VIII) as **X Chan 1** and **X Chan 1** and two portions of **Channel 1** are intensified.

Note: If you don't see two intensified portions on the trace of Channel 1, it is because the two intensified areas are touching each other.

- 8) Turn the **Time Magnifier** knob (47) to adjust the magnification factor (length of the intensified section) to cover the area of interest.

Notice that when you turn the **Time Magnifier** knob the two expanded portions of the waveform change their magnification factors simultaneously.

Choosing a region of interest

- 9) Displace the intensified section by adjusting **Horizontal Position** control (43).

Notice that the **Horizontal Position** knob operates simultaneously on both expanded portions of the waveform.

(Changing the Vertical Gain)

- 10) You can also adjust the **Vert Gain** control (46) to change the vertical magnification if required.

Example 4: Expanding Two Waveforms Simultaneously Dual Zoom Expansion ON

Acquiring signals

- 1) Use buttons (50) to (53) to switch Channels 1 and 2 on and all other traces off.
- 2) Acquire signals on Channels 1 and 2.
- 3) Set **Dual Grid**, button (14) ON.

- 4) Press the **Return** button (10) until the root menu is displayed (i.e. the only option available in the Menu field (II) is **Main Menu**).

Switching on the Expand functions

- 5) Switch **Expand A** and **Expand B** on (50). Notice two special features:
 - a) There is a highlighting frame around both expansions in the Displayed Trace field (VIII). One of the highlighting frames is made of dashed lines and the other of solid lines. The expansion function in the solid frame is the currently selected trace.
 - b) **Dual Zoom On** appears in the Menu field (II).

Note: If this is not the case, press button (5) to switch on the dual zoom expansion feature.

Choosing the waveforms to expand

- 6) If the sources for signal expansion shown in the Displayed Trace field (VIII) are not **X Chan 1** and **X Chan 2**, redefine the expansion signal sources to Channel 1 and Channel 2 using the redefine button as follows:
 - a) Use **Select**, button (49), to place the solid highlighting frame around the expansion function which is not set as you require.
 - b) Press the **Redefine** button (48) to display the Redefine Source menu in the Menu field (II).
 - c) Press the button corresponding to the required source for the expansion.

Choosing a magnification factor

- 7) At this point the sources for **Expand A** and **Expand B** are shown in the Displayed Trace field (VIII) as **X Chan 1** and **X Chan 2** and all or a portion of Channels 1 and 2 are intensified.
- 8) Turn the **Time Magnifier** knob (47) to adjust the magnification factor (length of the intensified section) to cover the area of interest.

Notice that when you turn the **Time Magnifier** knob the magnification factor changes simultaneously on both **Expand A** and **B**.

Choosing a region of interest

- 9) Displace the intensified section by adjusting **Horizontal Position** control (43).

Notice that the **Horizontal Position** knob also operates simultaneously on both **Expand A** and **B**.

(Moving the expanded waveform)

- 10) Position **Expand A** in the upper grid by selecting it and using the **Vertical Position** knob (44).
- 11) Position **Expand B** in the lower grid by selecting it and using the **Vertical Position** knob (44).

(Changing the Vertical Gain)

- 12) You can also adjust the **Vert Gain** control (46) to change the vertical magnification if required.

Example 5: Dual Zoom Expansion OFF

Acquiring signals

- 1) Use buttons (50) to (53) to switch Channels 1 and 2 on and all other traces off.
- 2) Acquire signals on Channels 1 and 2.
- 3) Set **Dual Grid**, button (14) ON.
- 4) Press the **Return** button (10) until the root menu is displayed (i.e. the only option available in the Menu field (II) is **Main Menu**).

Switching on the Expand functions

- 5) Switch **Expand A** and **Expand B** on (50). If dual zoom is on:
 - a) There is a highlighting frame around both expansions in the **Displayed Trace** field (VIII). One of the highlighting frames is made of dashed lines and the other of solid lines. The expansion function in the solid frame is the currently selected trace.
 - b) **Dual Zoom On** appears in the Menu field (II).

Switching Dual Zoom off

- 6) Press button (5) which corresponds to **Dual Zoom On** in the Menu field (II). **Dual Zoom Off** is now indicated and the dual zoom feature is no longer in operation.

Notice that only one of the expansion functions is surrounded by a select frame.

Choosing the waveforms to expand

- 7) If the sources for signal expansion shown in the Displayed Trace field (VIII) are not **X Chan 1** and **X Chan 2**, redefine the expansion signal sources to Channel 1 and Channel 2 using the redefine button as follows:
 - a) Use **Select**, button (49), to place the highlighting frame around the expansion function which is not set as you require.
 - b) Press the **Redefine** button (48) to display the Redefine Source menu in the Menu field (II).
 - c) Press the button corresponding to the required source for the expansion.

Choosing a magnification factor

- 8) At this point the sources for **Expand A** and **Expand B** are shown in the Displayed Trace field (VIII) as **X-Chan 1 X-Chan 2** and all or a portion of Channels 1 and 2 are intensified.
- 9) Turn the **Time Magnifier** knob (47) to adjust the magnification factor (length of the intensified section) to cover the area of interest.

Now when you turn the **Time Magnifier** knob the magnification factor changes only for the selected expansion function.

Choosing a region of interest

- 10) Displace the intensified section by adjusting **Horizontal Position** control (43).

Notice that the **Horizontal Position** knob only operates on the selected expansion function.

(Moving the expanded waveform)

- 11) Position **Expand A** in the upper grid by selecting it and using the **Vertical Position** knob (44).
- 12) Position **Expand B** in the lower grid by selecting it and using the **Vertical Position** knob (44).

(Changing the Vertical Gain)

- 13) You can also adjust the **Vert Gain** control (46) to change the vertical magnification if required.

WAVEFORM PROCESSING

Arithmetic

Example 1: Addition
of Channels 1 and 2

Acquire the signals for processing

- 1) Acquire signals on Channels 1 and 2.
- 2) Switch Channels 1 and 2 and Function E on. Switch all the other traces off, buttons (50) to (53).

Select a trace and redefine it

- 3) Press the **Select** button until the highlighting frame appears around Function E in the Displayed Trace field (VIII). Press the **Redefine** button (48) to call up the menu for Function E.

Set the required function

- 4) Use the **Previous Field** and **Next Field** buttons, (2) and (3), or the **Reference** knob (42) to select the **Class** field.
- 5) Use the **Previous Value** and **Next Value** buttons, (4) and (5), or the **Difference** knob (42) to set class to **Arithmetic**.
- 6) Select **Type** and set it to **Addition**.
- 7) Set **Max Number Of Points** to 500.
- 8) Set **Source 1** to **Channel 1**.
- 9) Set **Source 2** to **Channel 2**.
- 10) Press the **Return** button (10) to display the grid.

Example 2: Negation
of Channel 1

Acquire a signal to process

- 1) Acquire a signal on Channel 1.
- 2) Switch **Channel 1** and **Function F** on. Switch all the other traces off, buttons (50) to (53).

Select a trace and redefine it

- 3) Press the **Select** button until the highlighting frame appears around Function F in the Displayed Trace Field (VIII).

Press the **Redefine** button (48) to call up the menu for Function F.

Set the required function

- 4) Use the **Previous Field** and **Next Field** buttons, (2) and (3), or the **Reference** knob (42) to select the **Class** field.
- 5) Use the **Previous Value** and **Next Value** buttons, (4) and (5), or the **Difference** knob (42) to set class to **Arithmetic**.
- 6) Select **Type** and set it to **Negation**.
- 7) Set **Max Number Of Points** as required.
- 8) Set **Source** to **Channel 1**.
- 9) Press the **Return** button to display the grid.

Example 3: Summed Averaging

Acquire a signal to process

- 1) Acquire a repetitive signal on Channel 2, using normal trigger mode.
- 2) Switch **Channel 2** and **Function F** on. Switch all the other traces off, buttons (50) to (53).

Select a trace and redefine it

- 3) Press the **Select** button until the highlighting frame appears around Function F in the **Displayed Trace** field (VIII). Press the **Redefine** button (48) to call up the menu for Function F.

Set the required function

- 4) Use the **Previous Field** and **Next Field** buttons, (2) and (3), or the **Reference** knob (42) to select the **Class** field.
- 5) Use the **Previous Value** and **Next Value** buttons, (4) and (5), or the **Difference** knob (42) to set class to **Average**.
- 6) Set **Max Number Of Points** as required.
- 7) Set **Source** to **Channel 2**.
- 8) Set **Max number of sweeps** as required.
- 9) Press the **Return** button (10) to display the grid.

Summary: Waveform Processing

Sources: Channels 1 and 2
Functions: Summed averaging
Arithmetic- Identity
Negation
Addition
Subtraction

Procedure

Acquire the signal(s)
Select and redefine Function E or F
Set the required function



The purpose of this section is to offer some functional hints that will ensure the best possible operation of the instrument.

RAPID RESPONSE OF THE FRONT-PANEL CONTROLS

All the front-panel controls can be fully controlled remotely and are constantly monitored by the 9420/50's internal processor. Any action performed on the front panel is detected by the processor and the requested changes are implemented very rapidly.

During data acquisition (measurement of input signals), the internal processor is also busy with the data-taking controls, calculations and display generation. Under certain conditions, (e.g. RIS mode or slow time base), the response time of the front-panel controls increases. For example, when the user tries to move a trace up or down on the screen, it tends to move with a jumping motion.

Whenever slow response to the control knobs is noticed, set the trigger mode to SINGLE. Acquisition is stopped, the display of the waveform is frozen and the response time of control knobs returns to normal. Once the waveform manipulations have been done, return to Normal or Auto trigger.

ACCURATE AMPLITUDE MEASUREMENTS

The 9420/50's digitizers are 8-bit, analog-to-digital converters that measure the amplitude of input signals by subdividing them into 256 levels.

You can ensure maximum measurement accuracy by using the full dynamic range of the converters, i.e. using input signals close to full scale. Half-scale signals are in 128 levels only, reducing measurement accuracy by a factor of two.

To facilitate the adjustment of a full-scale ADC signal, the oscilloscope's display has been designed to represent the minimum level of the ADC as the bottom line of the grid. The maximum level is represented by the top line of the grid.

To make the best use of the ADC's dynamic range, and thereby achieve the most accurate amplitude measurements, the signal should completely fill the display grid as shown in Figure 67. The fully calibrated and continuously adjustable input-signal conditioning permits you to meet this requirement easily and without loss of calibration.

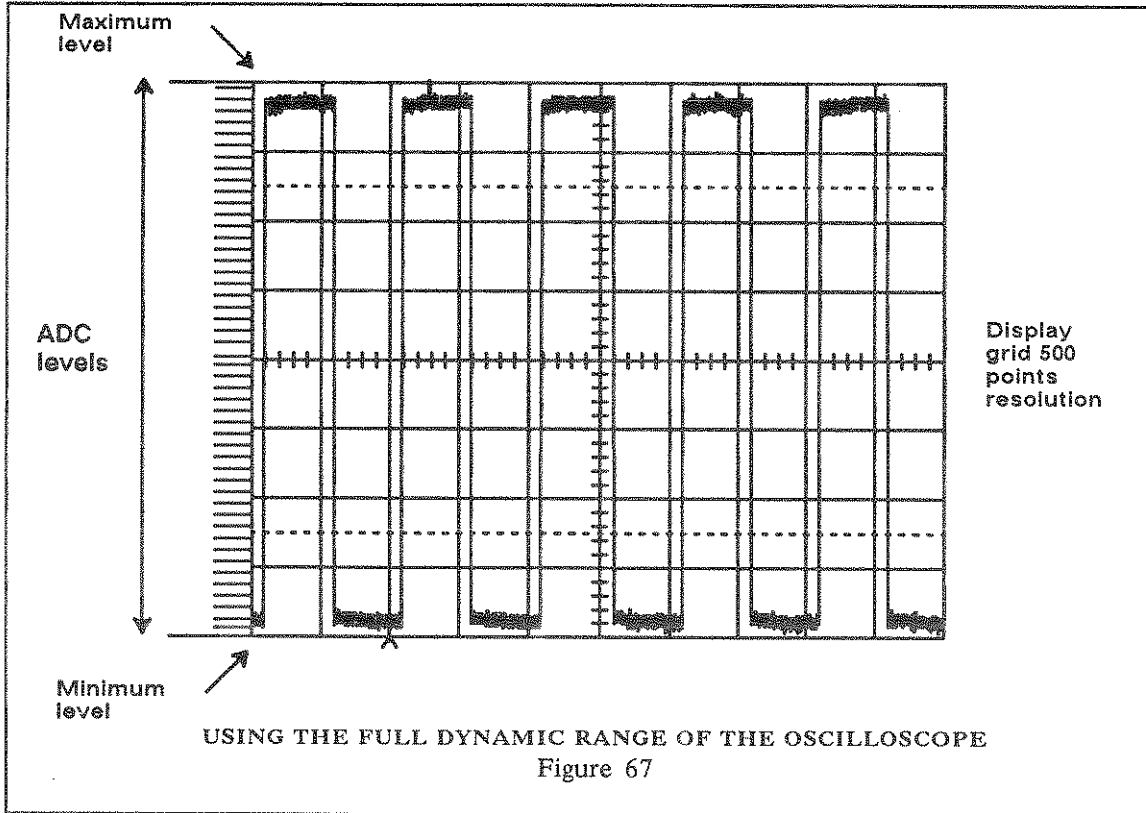

As an overlapping display of two full scale waveforms could become quite confusing, the 9420/50 provides a dual grid option to be used in applications where both channels are used simultaneously.

ACCURATE TIME MEASUREMENTS

Two deep acquisition memories, each storing up to 50,000 points, provide the unprecedented time resolution of the 9420/50.

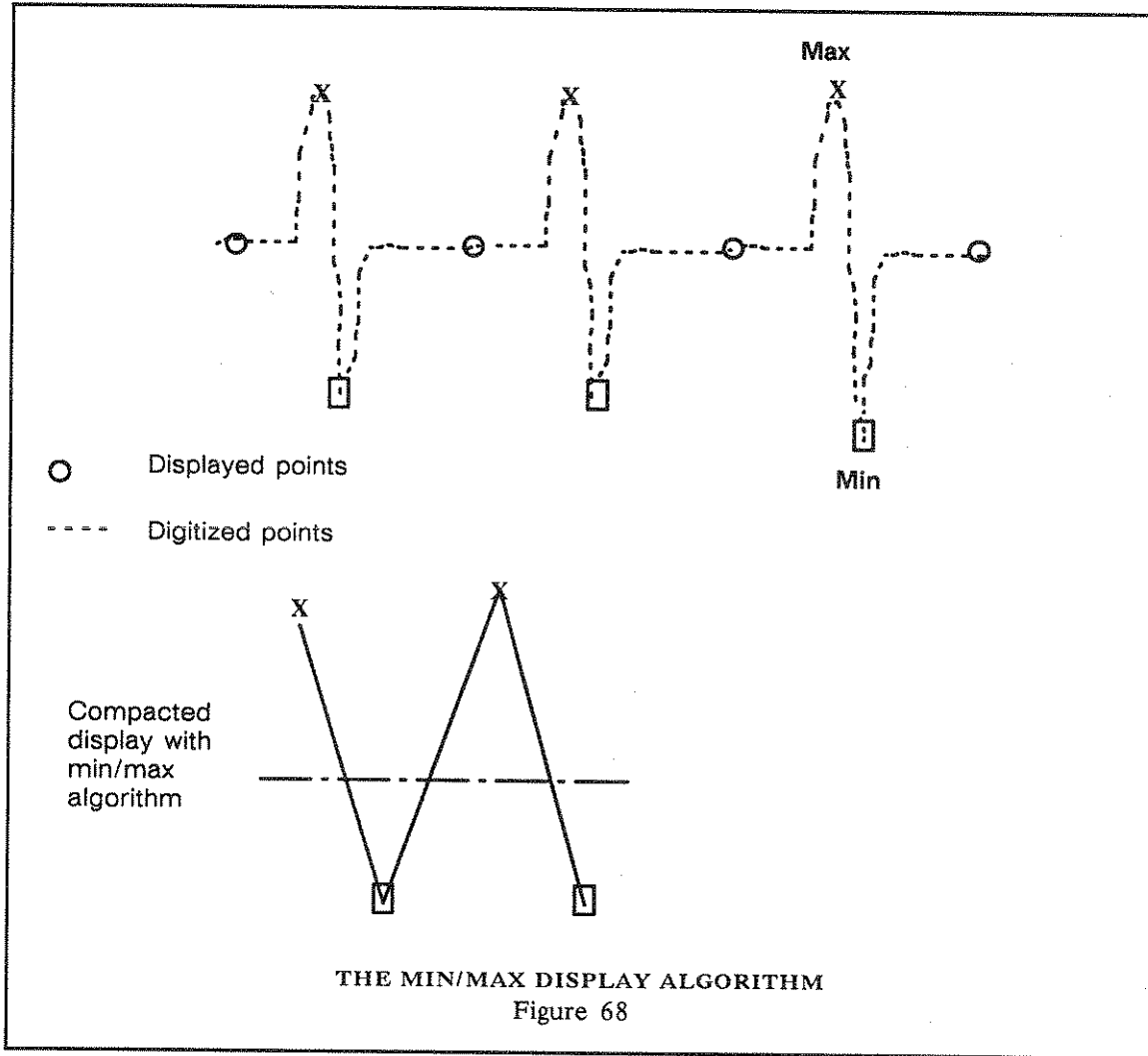

These points are displayed on the screen with a resolution of 500 display points. A compacting algorithm showing all minimum and maximum values ensures that no information is lost when a trace is displayed (see Figure 68). Time cursors can be positioned accurately on any one of the 500 display points of a compacted trace. The corresponding measurement accuracy is 1/500 or 0.2% of the time-base setting.



To improve measurement accuracy, two expansion functions, **Expand A** and **Expand B** are provided to display every digitized point trace. Expansion up to 1000 times is possible. When the expansion factor is such that 500 measured points are to be displayed, every display point corresponds to a digitized point.

When the time base requires that less than 500 digitized points fill the screen, the oscilloscope interpolates using straight line seg-

ments between the actual points. If 200 or less points are used, the digitized points are clearly visible as intensified points on the display. When a cursor is placed on an actual measured point, a small horizontal bar appears on the cursor as follows:

Time cursor: 
 Cross-hair marker: 

In Figure 69 the compacted trace of a 50000 point waveform is expanded by a factor of 1000 with Expand A and B to provide maximum time measurement accuracy. Under these conditions, each expanded trace displays 50 digitized points. Using these data points the time measurement resolution is $1/50000 = 0.002\%$ of the original time-base setting. If the linear interpolation is appropriate, the accuracy can be increased by a factor of 10.

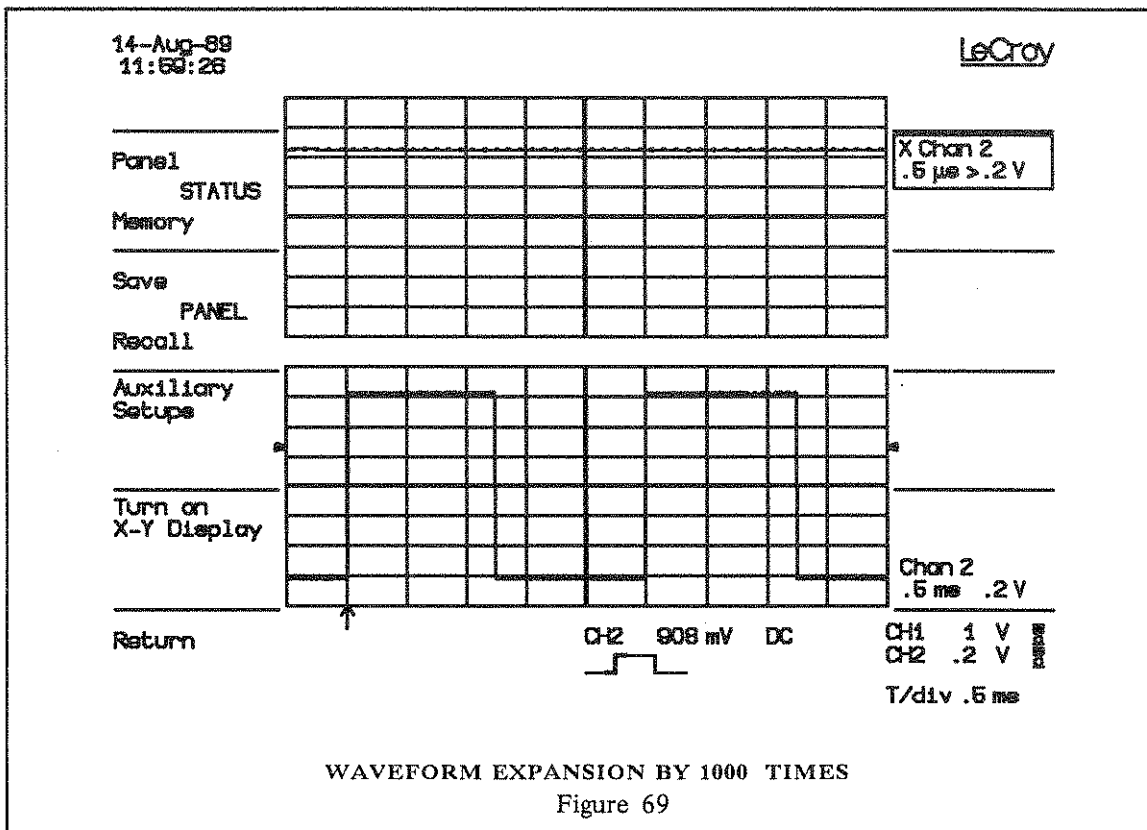

AUTO-CALIBRATION

The 9420/50 calibrates its time interpolator relative to the internal 100 MHz crystal-controlled clock generator every time the time base is modified by front-panel operation or by remote control.

The vertical gain and offset of an input channel are calibrated by means of a very stable internal 12-bit digital-to-analog converter every time the fixed gain control of this channel is modified. Calibration of both channels also takes place whenever the bandwidth limit is changed.

These calibrations are necessary largely because of drifts caused by temperature changes which could arise if the oscilloscope is left in the same state for a very long time. To avoid measurement errors due to potential drifts, the 9420/50 regularly performs an auto-calibration. This operation is transparent to the user, but is audible due to relay switching. Note that auto-calibration does not occur when the oscilloscope is waiting for a trigger or actually acquiring data. It only occurs before a new acquisition is started.

In remote control, it is possible to issue a command to turn off all auto-calibration. Such a command can be sent at any time.

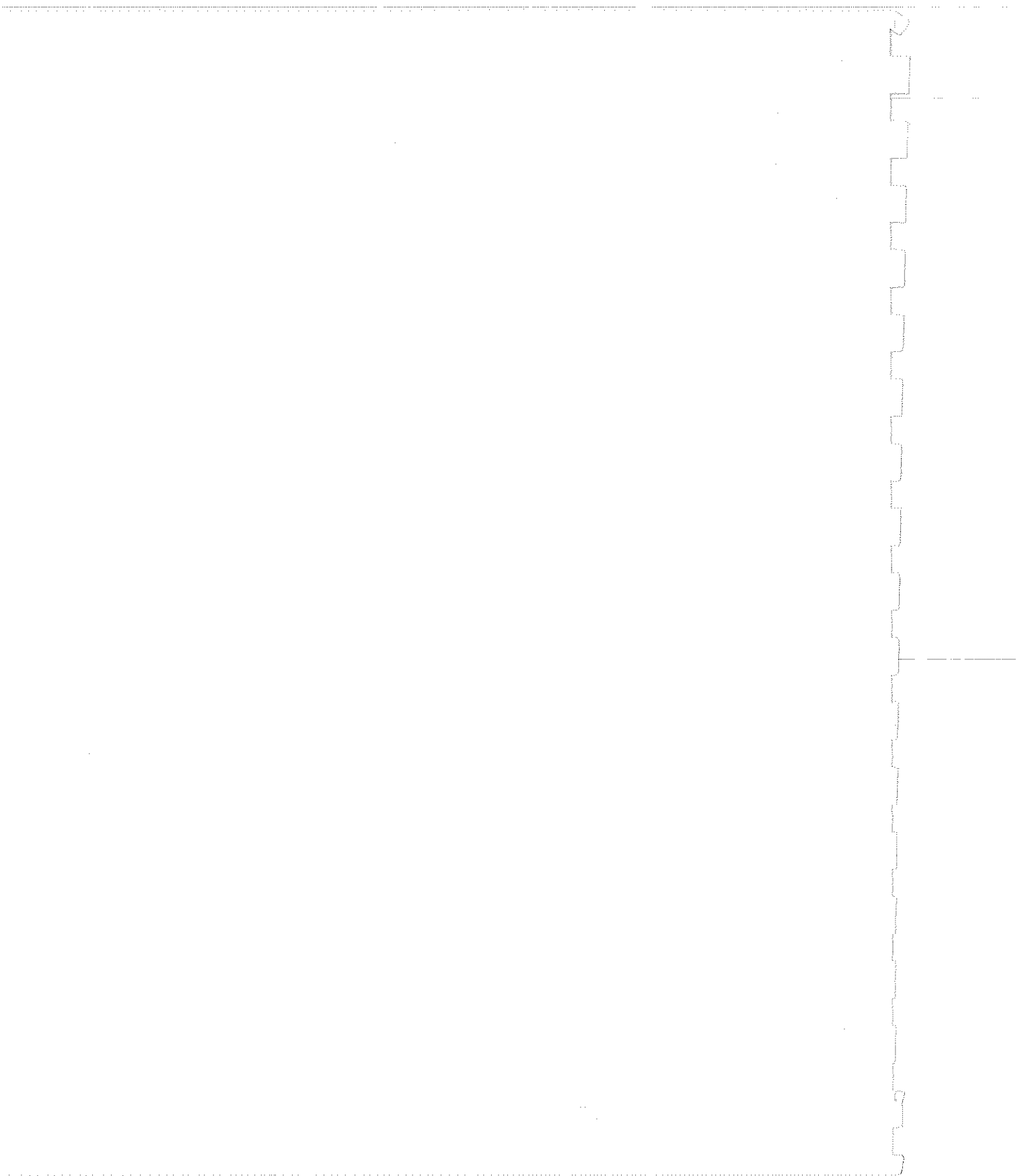

The WP01 Waveform Processing Option adds enhanced processing capabilities to the standard oscilloscope functions described in Section 6. The package provides five classes of operation:

Average:	Summed and Continuous.
Arithmetic:	Identity, Negation, Reciprocal, Addition, Subtraction, Multiplication and Ratio.
Extrema:	Roof for maxima, Floor for minima, Roof and Floor for maxima and minima.
Functions:	Integral, Derivative, Square, Square Root, Logarithm e, Exponential e, Logarithm 10, Exponential 10 and Absolute.
Enhanced Resolution:	A digital filtering technique to improve signal-to-noise ratio and improve vertical resolution.

This section describes the WP01 option. The remote commands for the control of WP01 processing as well as waveform transfer to and from a host computer are listed in the Remote Control Manual.

PROCESSING CAPABILITIES

Processing can be performed on any source waveform (Channels 1 and 2, Expand A and B, Memory C and D, Functions E and F) and may be activated by pressing Function buttons E or F (52). Waveform processing is automatic as long as a function trace (or an expansion of a function) is switched ON. Using both Functions E and F enables simultaneous computation of two different processing routines.

The display control knobs ((44) and (46)) may be used to adjust the vertical position and vertical gain of a selected function. Functions may also be expanded horizontally by redefining the source waveform of the Expand A and B traces.

Processed waveforms can be read by remote control, stored in reference memories, expanded or processed in the other functions. Chaining of operations is also possible.

Waveform processing can take an appreciable execution time when operating on many data points. The user can reduce the execution time by limiting the **Max Number of Points** which is used in the computation. However, users should be aware that reducing the number of processed points effectively reduces the sampling rate of the input record and the corresponding Nyquist frequency and may lead to aliasing.

The oscilloscope executes the waveform processing function on the entire waveform (as displayed on the screen) by taking every

11 *Waveform Processing Option (WP01)*

Nth point, N depending on the time base and the **Max Number Of Points** selected. The first point of such a reduced record is the first valid point of the input record, usually the point on the left-hand edge of the screen.

The user can modify a processing definition either from a front-panel menu, which may be called by pressing the **Redefine** button (48), or through remote commands.

If the user has set up a circular definition (e.g. $FE = \text{func}(FF)$ and $FF = \text{func}(FE)$), a warning message is displayed and no processing is applied to the waveforms.

Setting Up a Waveform Processing Function

It is generally good practice to stop data acquisition while preparing new conditions for waveform processing (by setting the trigger mode (28) to **Single**) because the response time might be slow for some function setups. To access the function menus, use the **Select** button (49) to make sure that the function is selected (i.e. is surrounded by a solid box in the Displayed Trace Field (VIII)), and then press **Redefine** (48). A full page setup menu will appear on the screen. To return to the normal waveform display, press either the "Return" button (10) or the **Redefine** (48) button.

In the function menu, the function and its parameters may be modified with buttons (2) to (5). First select the field to be modified. The rectangular frame around parameter values indicates the currently selected field. Pressing the **Previous Field** button (2) will cause the frame to move towards the top of the list, whereas pressing the **Next Field** button (3) will cause the frame to move downwards. As an alternative, the **Reference knob** (42) may be used to rapidly move through the fields.

After field selection, the current value of the field may be modified by pressing either the **Previous** or **Next Value** button ((4) or (5)) or using the **Difference knob** (42). Since the identity of the lower fields may depend on the function chosen, modify the parameters from top to bottom.

SUMMED AVERAGE

Summed averaging consists of the repeated addition, with equal weight, of successive source waveform records. If a stable trigger is available, the resulting average has a reduced random noise component, compared with a single-shot record. Whenever the maximum number of sweeps is reached, the averaging process stops. The process may be interrupted by switching the trigger mode from **Norm** to **Single** (28) or by turning the function trace **OFF** (52). Averaging will continue when these actions are reversed.

The accumulated average may be reset by changing an acquisition parameter, such as input gain, offset or coupling, trigger condition,

time base or bandwidth limit. The number of currently averaged waveforms (of the function or of its expansion) is displayed in the Displayed Trace field (VIII).

Whenever the maximum number of sweeps is reached, a larger number of sweeps may be accumulated by simply changing the maximum number of sweeps in the setup menu. In this case care must be taken to leave the other parameters unchanged, otherwise a new averaging calculation is started.

A waveform to be added to the average may contain overflow or underflow values (corresponding to the saturation levels of the ADC). By using artifact rejection, the user may choose whether to reject or accept these waveforms.

If **Artifact Rejection** is OFF, the waveform is added to the average. Of course, the average will be incorrect at the positions where overflow or underflow occurred.

If **Artifact Rejection** is ON, waveforms containing any overflows or underflows are not added to the average. If waveforms consistently contain overflows or underflows, averaging cannot proceed and the number of accumulated sweeps may remain constant indefinitely.

In order to further improve the signal-to-noise ratio, the instrument offers the possibility of performing offset dithering. When **Dithering** is turned ON, a small hardware offset, of between +6 and -6 LSB of the 8-bit ADC (about 1/5 vertical division) is added to the input signal before acquiring a waveform. The offset is changed for successive waveforms, and the average of the offsets tends to zero. Because dithering makes each successive waveform use a slightly different portion of the ADC, the differential non-linearities of the ADC also tend to be averaged out. Care must be taken that the amplitude of the waveform does not fall within 1/5 of a vertical division from the top and the bottom of the display grid since overflows or underflows might occur. When dithering, the channel waveforms are compensated for the dither offset so that the waveform values, as read out by remote control or by cursor measurements, remain unaffected.

Offset dithering is mainly of interest when the waveform to be averaged is already relatively "clean", i.e. contains noise variations of less than 1/5 division. In such a case, differential non-linearities can be reduced by up to a factor of 4. In contrast, waveforms which have high levels of noise (>1/5 of a vertical division) do their own "dithering", making artificial offset variations superfluous.

11 Waveform Processing Option (WP01)

When summed averaging is turned on, the display is updated at a reduced rate (about once every 1.5 sec), to increase the averaging speed (points per second and events per second).

Before processing, the source waveform may be decimated by a factor depending on the selected Max Number of Points and the source record number of points. The resulting number of points is displayed at the bottom of the function menu. An example of the function menu for summed averaging is shown in Figure 70.

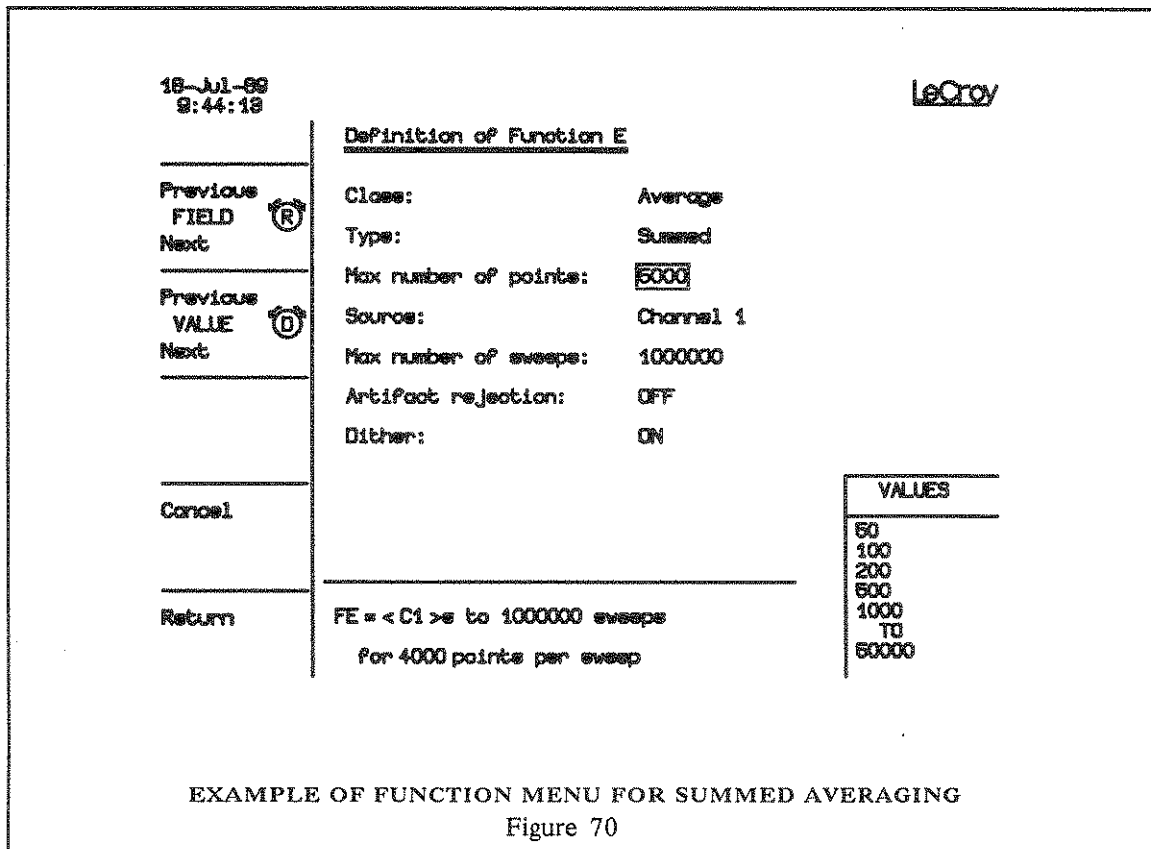

CONTINUOUS AVERAGE

Continuous averaging (also called exponential averaging) consists of the repeated addition, with unequal weight, of successive source waveforms. The technique is particularly useful for reducing noise on signals which drift very slowly in time or amplitude. Each new record is added to the accumulated average according to the formula:

$$S(i, new) = \frac{N}{N+1} [S(i, old)] + \frac{1}{N+1} [W(i)]$$

where

i index over all data points of the waveforms

W(i) newly acquired waveform

S(i, old) old accumulated average

S(i, new) new accumulated average

N Weight, may be 1, 3, 7, 15, 31, 63, 127

The factors $N/(N+1)$ and $1/(N+1)$ determine the weighting at which the continuous average is applied to the source waveform. Note that the sum of the two factors adds up to the value of 1, so that the continuous average of noisy, but otherwise repetitive waveforms, resembles the summed average of such waveforms. However, the statistics of a continuous average tend to be worse than those from a summed average on the same number of sweeps, since the most recently acquired waveform has more weight than all previously acquired ones. Therefore, the continuous average is dominated by the statistical fluctuations of the most recently acquired waveforms.

The weight of "old" waveforms in the continuous average gradually tends to zero, at a rate which decreases with the increase of *N*.

The averaging process may be interrupted by switching the trigger mode from **Norm** to **Single** (28) or by turning the function trace **OFF** (52). Averaging will continue when these actions are reversed. The currently accumulated average may be reset by changing an acquisition parameter, such as input gain, offset or coupling, trigger condition, time base or bandwidth limit.

Before processing, the source waveform may be decimated by a factor depending on the selected **Max Number of Points** and the source record number of points. The resulting number of points is displayed at the bottom of the function menu. See Figure 71 for an example of the function menu with continuous averaging.

11 Waveform Processing Option (WP01)

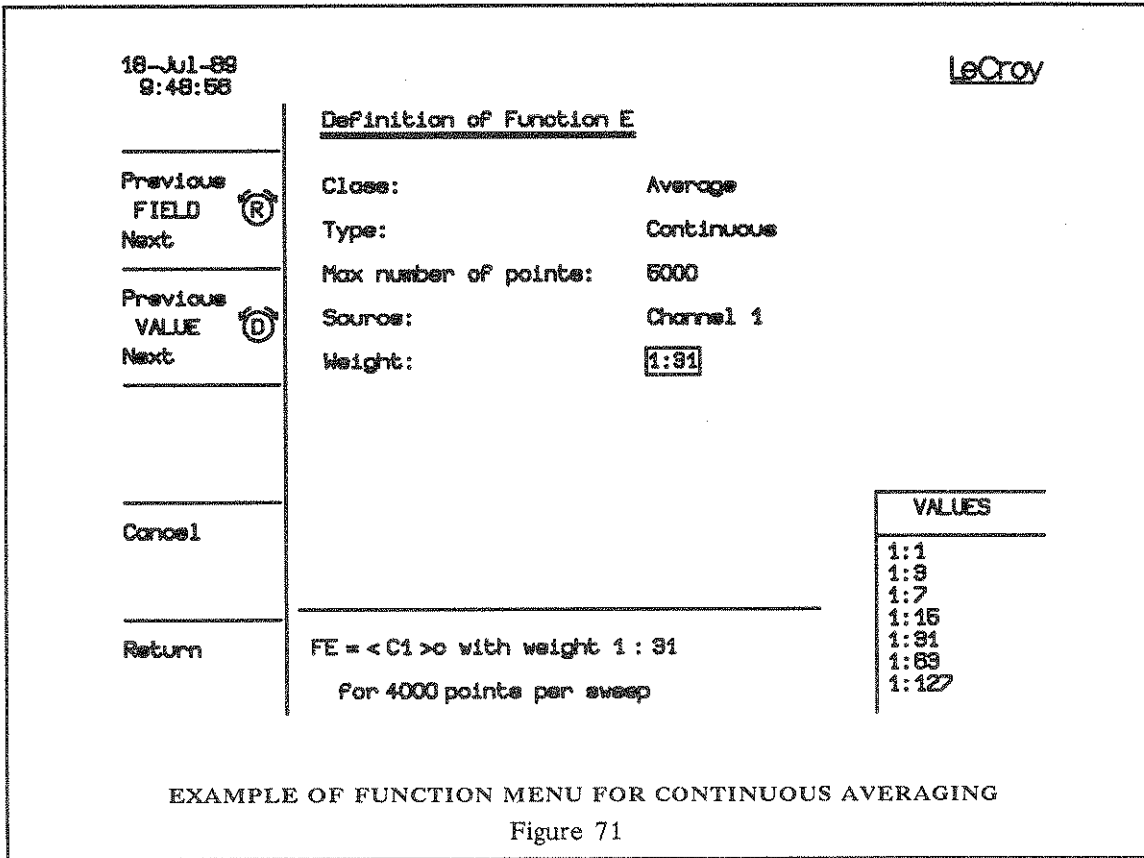

ARITHMETIC

Identity, Negation and Reciprocal can be computed from any source waveform and Addition, Subtraction, Multiplication and Ratio can be computed for any pair of compatible waveforms.

The arithmetic operations are applied to one or two source waveforms on a data point per data point basis. Different vertical gains and offsets of the two sources are automatically taken into account in the computed result. However, both source waveforms must have the same time base. The trigger point may be different in the two source waveforms, although in this case the results may be difficult to interpret.

Before processing, the source waveform may be decimated by a factor depending on the selected Max Number of Points and the source record number of points. The resulting number of points is displayed at the bottom of the function menu.

Before processing, the Source 1 waveform may be multiplied by a constant **Multiplication Factor** in the range 0.001×10^{-33} to 999.999×10^{33} and be offset by an **Additive Constant** in the range -999.999×10^{33} to 999.999×10^{33} times the vertical unit of the Source 1 waveform. An example of the function menu set up for the subtraction of Channel 1 from Channel 2 is shown in Figure 72.

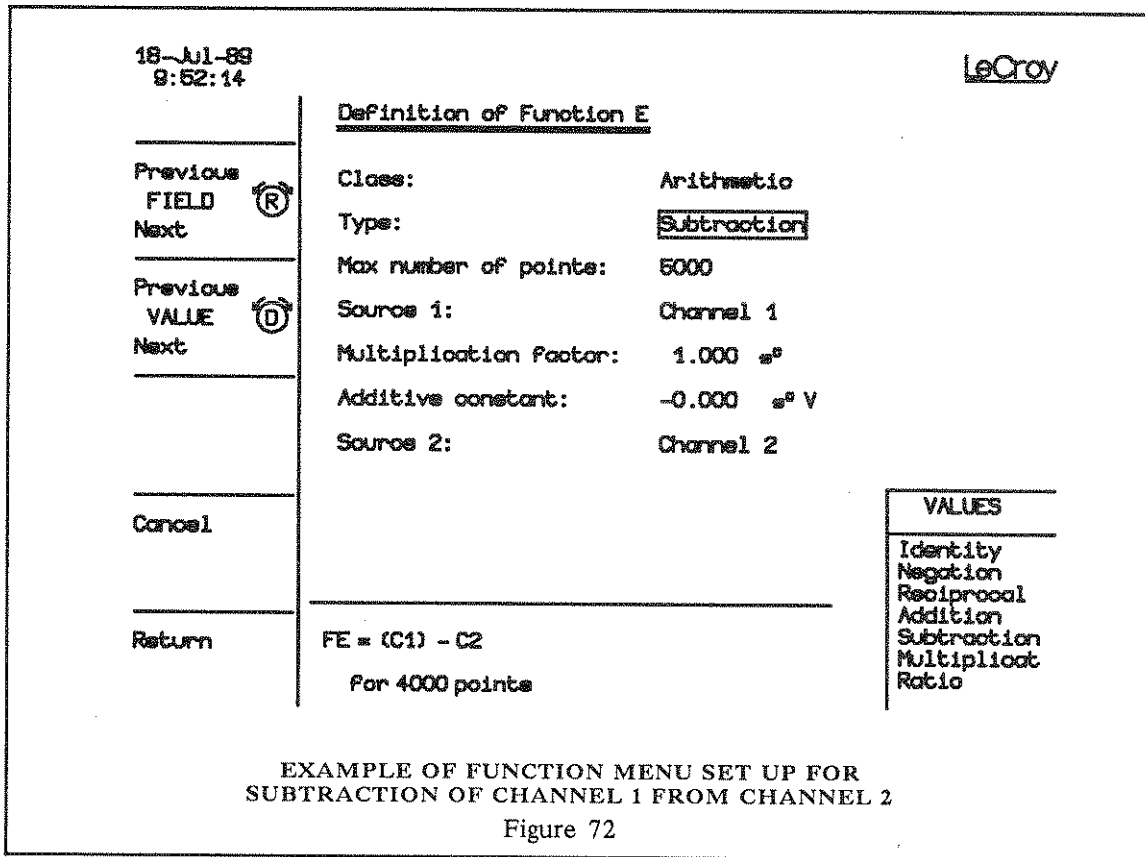

EXTREMA

Extrema waveforms are computed by a repeated comparison of successive source waveform records with the already accumulated extrema waveform, which consists of a maxima record (roof) and a minima record (floor). Whenever a given data point of the new waveform exceeds the corresponding maximum value in the roof record, it replaces it. If the new data point is smaller than the cor-

11 *Waveform Processing Option (WP01)*

responding floor value, it replaces it. Thus the maximum and the minimum envelope of all waveform records is accumulated.

Roof and Floor records can be displayed individually or both together.

Whenever the selected maximum number of sweeps is reached, the accumulation process stops. The process may be interrupted by switching the trigger mode from **Norm** to **Single** (28) or by turning the function trace **OFF** (52). Accumulation will continue when these actions are reversed. The currently accumulated extrema waveform may be reset by either changing an acquisition parameter, such as input gain, offset or coupling, trigger condition or the time base or bandwidth limit. The number of currently accumulated waveforms is displayed in the **Displayed Trace** field (VIII) of the function or of its expansion.

Whenever the maximum number of sweeps is reached, a larger number of sweeps may be accumulated by simply changing the maximum number of sweeps in the setup menu. In this case, care must be taken to leave the other parameters unchanged, otherwise the extrema calculation is started again.

Before processing, the source waveform may be decimated by a factor depending on the selected **Max Number of Points** and the source record number of points. The resulting number of points is displayed at the bottom of the function menu. An example of the function menu set up for roof and floor extrema is shown in Figure 73.

18-Jul-89
9:55:48

LeCroy

Previous FIELD R

Next

Previous VALUE D

Next

Cancel

Return

Definition of Function E

Class: Extrema

Type: Roof + Floor

Max number of points: 20000

Source: Channel 1

Max number of sweeps: 7500

FE = rF+f1 (C1) for 7500 sweeps
for 20000 points per sweep

VALUES

TO 1

1000000

EXAMPLE OF FUNCTION MENU SET UP FOR
ROOF AND FLOOR EXTREMA

Figure 73

FUNCTIONS

The following mathematical functions can be applied to any waveform: Integral, Derivative, Square, Square Root, Logarithm e, Exponential e, Logarithm 10, Exponential 10 and Absolute Value.

Square Root is actually computed on the absolute value of the source waveform.

For logarithmic and exponential functions the numerical value (without units) of the input waveform is used.

Before processing, the Source waveform may be decimated by a factor depending on the selected Max Number of Points and the source record number of points. The resulting number of points is displayed at the bottom of the function menu.

Before processing, the source waveform may be multiplied by a constant **Multiplication Factor** in the range 0.001×10^{-33} to 999.999×10^{33} and be offset by an **Additive Constant** in the range -999.999×10^{33} to 999.999×10^{33} times the vertical unit of the source waveform.

ENHANCED RESOLUTION Quite often the high sampling rate available in LeCroy oscilloscopes is higher than is actually required for the bandwidth of the signal being analyzed. This oversampling, facilitated by the oscilloscope's long memories, can be used to advantage by filtering the digitized signal in order to increase the effective resolution of the displayed trace. This is similar to smoothing the signal with a simple moving average filter, except that it is more efficient in terms of bandwidth, and has better passband characteristics. It therefore finds application in situations where averaging of successive traces would be useful but can't be employed because the signal has single-shot characteristics.

Advantages of Enhanced Resolution

Two subtly different characteristics of the instrument are improved by the enhanced resolution filtering:

1. In all cases the resolution (i.e. the ability to distinguish closely spaced voltage levels) is improved by a fixed amount for each filter. This is a true increase in resolution which occurs whether or not the signal is noisy, and whether or not it is a single-shot or a repetitive signal.
2. The signal-to-noise ratio (SNR) is improved in a manner which depends on the form of the noise in the original signal. This occurs because the enhanced resolution filtering decreases the bandwidth of the signal, and will therefore filter out some of the noise.

Implementation

The oscilloscope implements a set of linear phase finite impulse response (FIR) filters, optimised to provide fast computation, excellent step response and minimum bandwidth reduction for resolution improvements of between 0.5 and 3 bits in 0.5 bit steps. Each 0.5 bit step corresponds to a bandwidth reduction by a factor of two, allowing easy control of the bandwidth/resolution trade-off. The parameters of the six filters are given in the following table:

Resolution Increase (Enhancement)	-3 dB Bandwidth (\times Nyquist)	Filter Length (samples)
0.5	0.5	2
1	0.241	5
1.5	0.121	10
2	0.058	24
2.5	0.029	51
3	0.016	117

**Parameters of the FIR
Enhanced Resolution Filters**

The filters used are low-pass filters, so the actual increase in SNR obtained in any particular situation will depend on the power spectral density of the noise present on the signal. The improvement in SNR corresponds to the improvement in resolution if the noise in the signal is white, i.e. evenly distributed across the frequency spectrum. If the noise power is biased towards high frequencies then the SNR improvement will be better than the resolution improvement. Whereas if the noise is mostly at lower frequencies, the improvement may not be as good as the resolution improvement. The improvement in the SNR due to the removal of coherent noise signals (for example, feed-through of clock signals) depends on whether the signal falls in the passband of the filter or not. This can easily be deduced by using the spectrum analysis option (WP02) of the oscilloscope.

As an aid to choosing the appropriate filter for a given application, the Enhanced Resolution menu (see Figure 74) indicates the -3 dB bandwidth of the current filter in two ways. Firstly as a percentage of the Nyquist frequency, and secondly the actual frequency that this corresponds to for the time-base setting of the current waveform.

11 Waveform Processing Option (WP01)

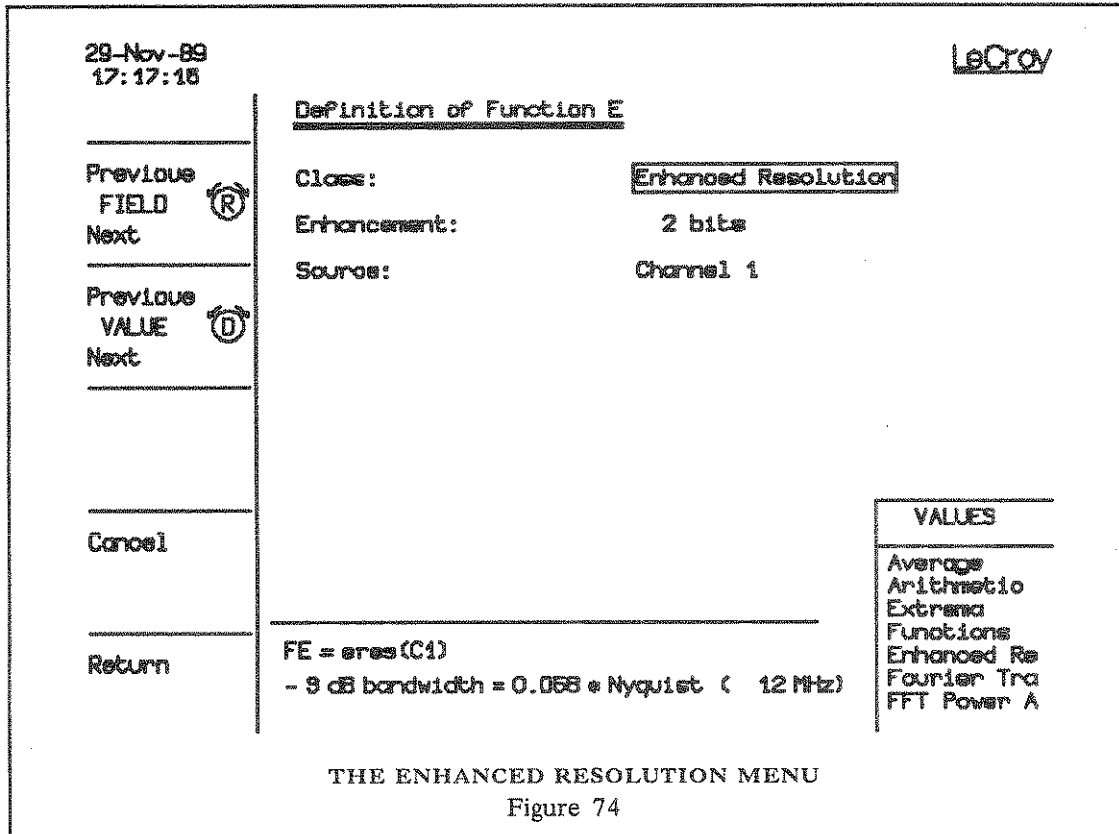

The filters used for the enhanced resolution function have an exactly linear phase response. This has two desirable properties. Firstly, the filters do not distort the relative position of different events in the waveform even if the frequency content of the events is different. Secondly, by also using the fact that the waveforms are stored, the delay normally associated with filtering (between the input and output waveforms) can be exactly compensated for during the computation of the filtered waveform.

All filters have been implemented to have exactly unity gain (at low frequency). Therefore, enhanced resolution should not cause overflow if the source data were not overflowed. If part of the source trace had overflowed, filtering will be allowed, but it must be remembered that the results in the vicinity (within the length of the filter impulse response) of the overflowed data will be incorrect. This is permitted because in some circumstances an overflow

may be a spike of only one or two samples. The energy in this spike might not be sufficient to significantly affect the results, so it would be undesirable to disallow the whole trace in this case.

When should Enhanced Resolution be used?

There are two main situations for which enhanced resolution is especially useful. Firstly, if the signal is noticeably noisy (and measurements of the noise are not required), the signal can be "cleaned up" by using the enhanced resolution function. Secondly, even if the signal is not particularly noisy, but high precision measurements of the waveform are required (perhaps when using Expand with high vertical gain) then enhanced resolution will increase the resolution of the measurements.

In general, enhanced resolution replaces the averaging function in situations where the data record has a single-shot or slowly repetitive nature and averaging cannot be used.

The following examples illustrate uses of the enhanced resolution function in these situations.

11 Waveform Processing Option (WP01)

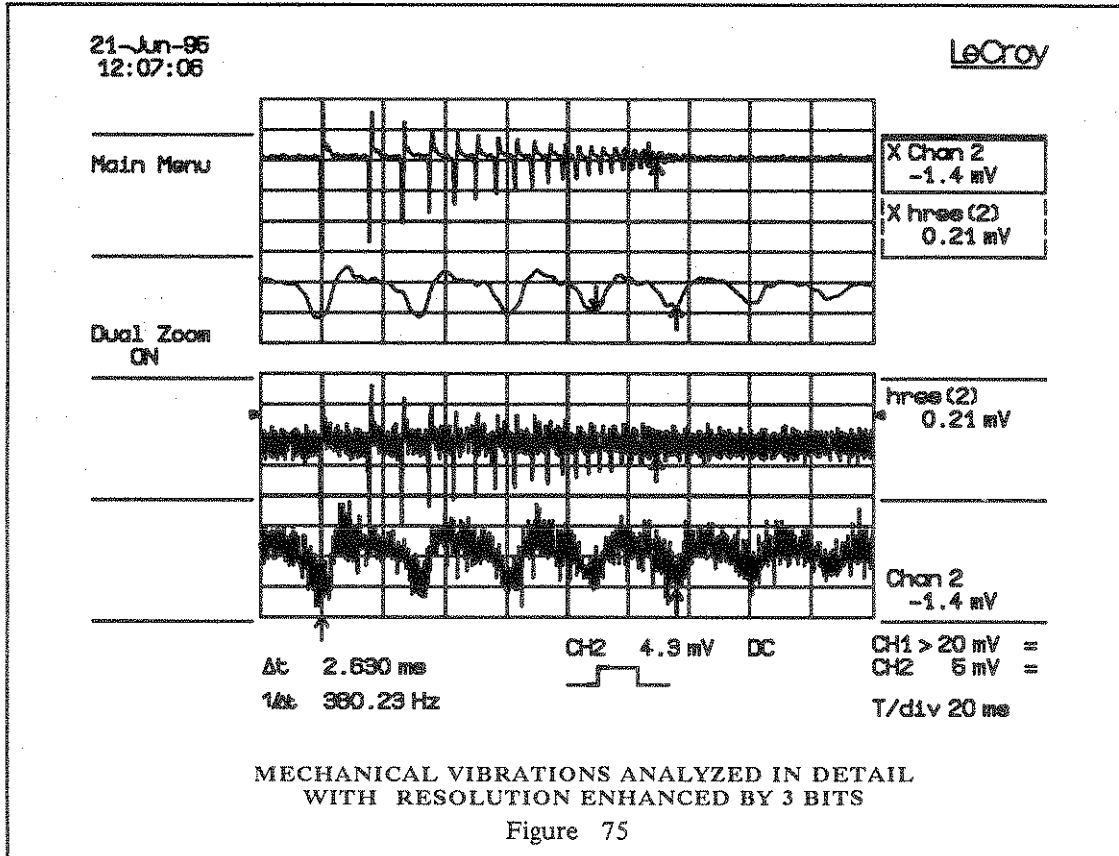
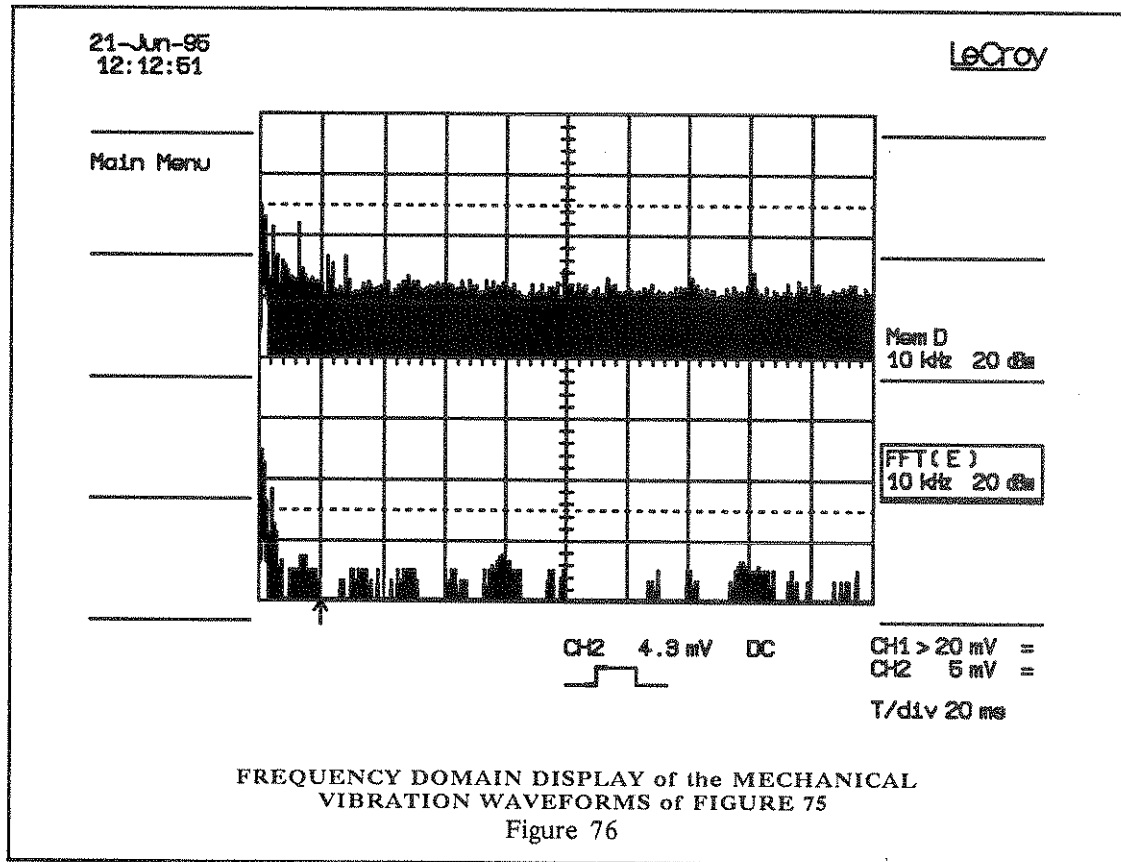

Figure 75 shows the effect of enhanced resolution on a single-shot mechanical vibration, where the trace is scaled according to the event which caused the trigger, but the small vibrations in the tail of the response are also of interest. The lower grid shows the original signal, the bottom trace being the expansion ($\times 5$ vertically, $\times 10$ horizontally) of the trace above. The expansion is of approximately the 7th time division from the left. The upper grid shows the same signals after 3-bit resolution enhancement. Without enhanced resolution the small oscillations were completely lost in the noise, but with it the approximately 1 mV oscillations can easily be seen and measured.



For the above case the filtering effect of the enhanced resolution function is also shown in the frequency domain by the FFT function (available as an option). Figure 76 shows the power spectrum of the signals in Figure 75. The upper trace is the spectrum of channel 2, and the lower trace is the spectrum of Function E, i.e. channel 2 after enhanced resolution filtering. The 3.0 bit enhancement filter has a -3 dB bandwidth of 0.016 times the Nyquist frequency, which is about 1/6th of a horizontal division. The filter removes energy from the signal above this frequency. The residual spikes in the lower trace at the -80 dB level are due to the processing noise (finite arithmetic effects) of long FFT computations.

Figure 77 shows a relatively noise-free step response (upper trace). The middle trace is the expansion ($\times 5$ vertically, $\times 25$ horizontally) of this step response in the region of the initial peak. The lower trace, which is the expansion of the same step response after

11 Waveform Processing Option (WP01)

1-bit enhanced resolution filtering, clearly shows the advantage of even a modest resolution enhancement of 1 bit.

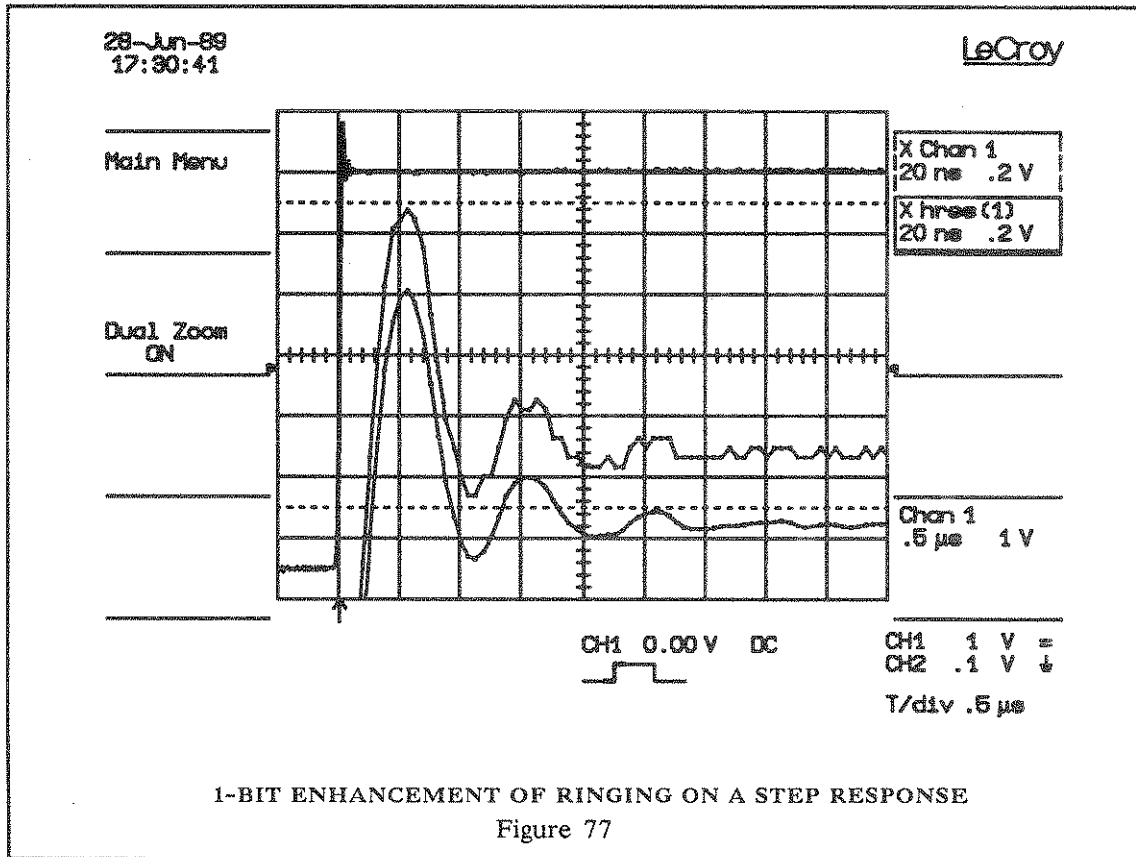

Enhanced Resolution on RIS waveforms

Enhanced resolution can almost always be used on RIS waveforms without any loss of bandwidth because the RIS traces are usually highly oversampled with respect to the analog bandwidth of the oscilloscope. For example, at least 1-bit enhancement can always be used for RIS waveforms with a time base of 1 μ sec/div or faster. This is illustrated in Figure 78 where a 100 MHz signal is displayed with (top trace) and without (second trace) 1-bit resolution enhancement. The improvement can easily be seen on the 5 times vertically expanded traces shown below. In this case the -3 dB bandwidth of the digital enhanced resolution filter was 1 GHz, and

thus it has no significant effect on the signal bandwidth of the instrument.

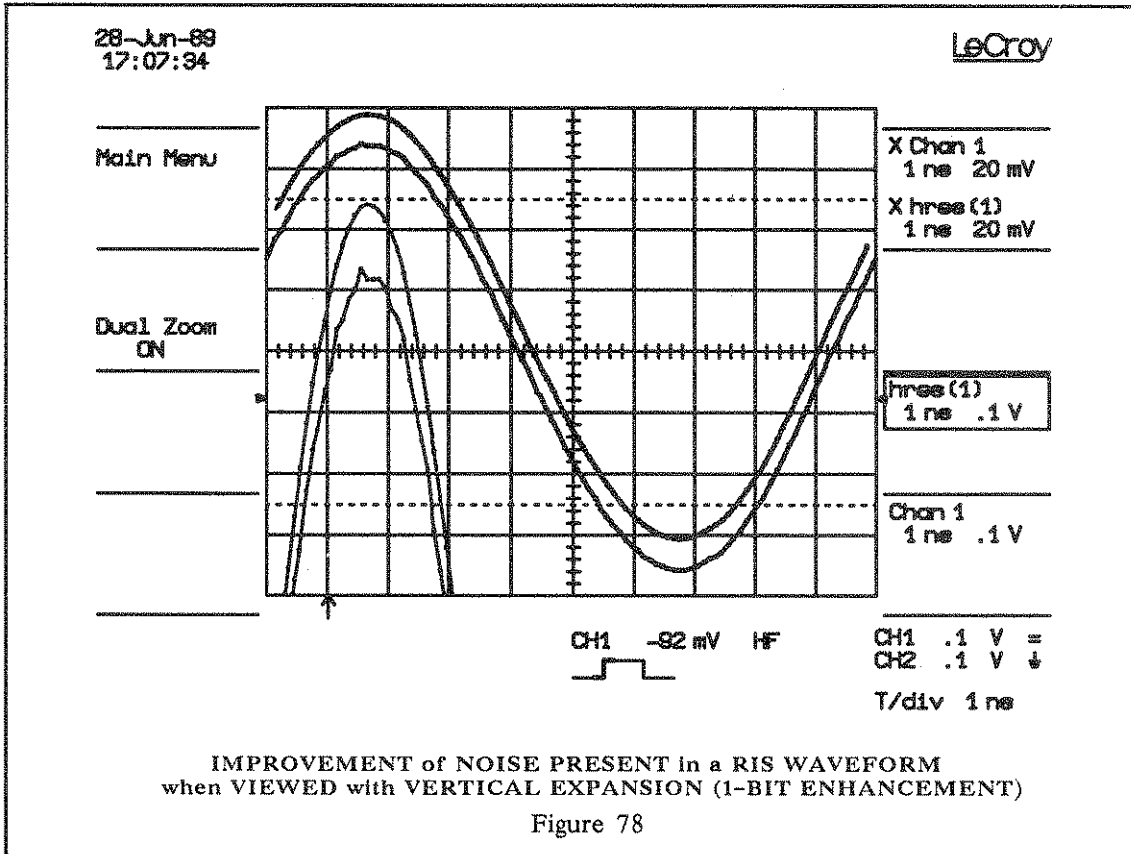

Conversely, RIS is very useful for increasing the sampling frequency of repetitive signals prior to enhanced resolution filtering even if RIS wouldn't be used for the normal trace. This is because the -3dB bandwidth of the filter is increased by the increase in effective sampling frequency and a more severe filter (greater enhancement) can be used for a similar loss of bandwidth. This is illustrated in Figure 79, which is the same as Figure 77 except that RIS was switched on, allowing the enhancement to be increased to 3 bits.

11 Waveform Processing Option (WP01)

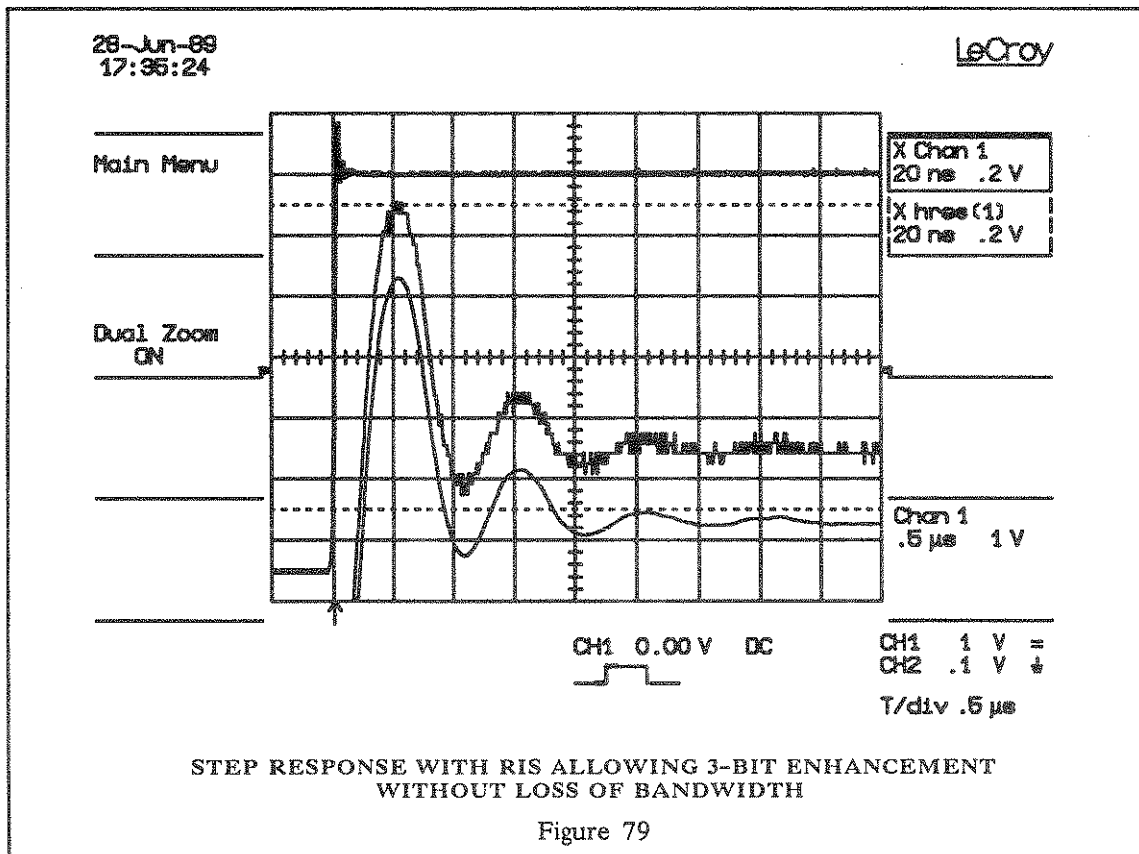

Signal filtering with the Enhanced Resolution Function

As the filters used for increasing the resolution are low-pass filters, they can also be used as low-pass signal filters in some situations. With careful choice of the filter bandwidth as a percentage of Nyquist frequency (via choice of the filter's resolution increase) and of the Nyquist frequency (via choice of the time base), the filters can be used to remove or reduce the effects of high-frequency interfering signals. The spectrum analysis function will be an invaluable aid to determining the relationship between the different component frequencies of the signal. Using, for example, FFT Power Density this information can conveniently be seen directly in terms of the current Nyquist frequency, so the correct choice of filter becomes simple. The spectrum analysis can also be used

after filtering to confirm the presence, or otherwise, of the various components of the original signal.

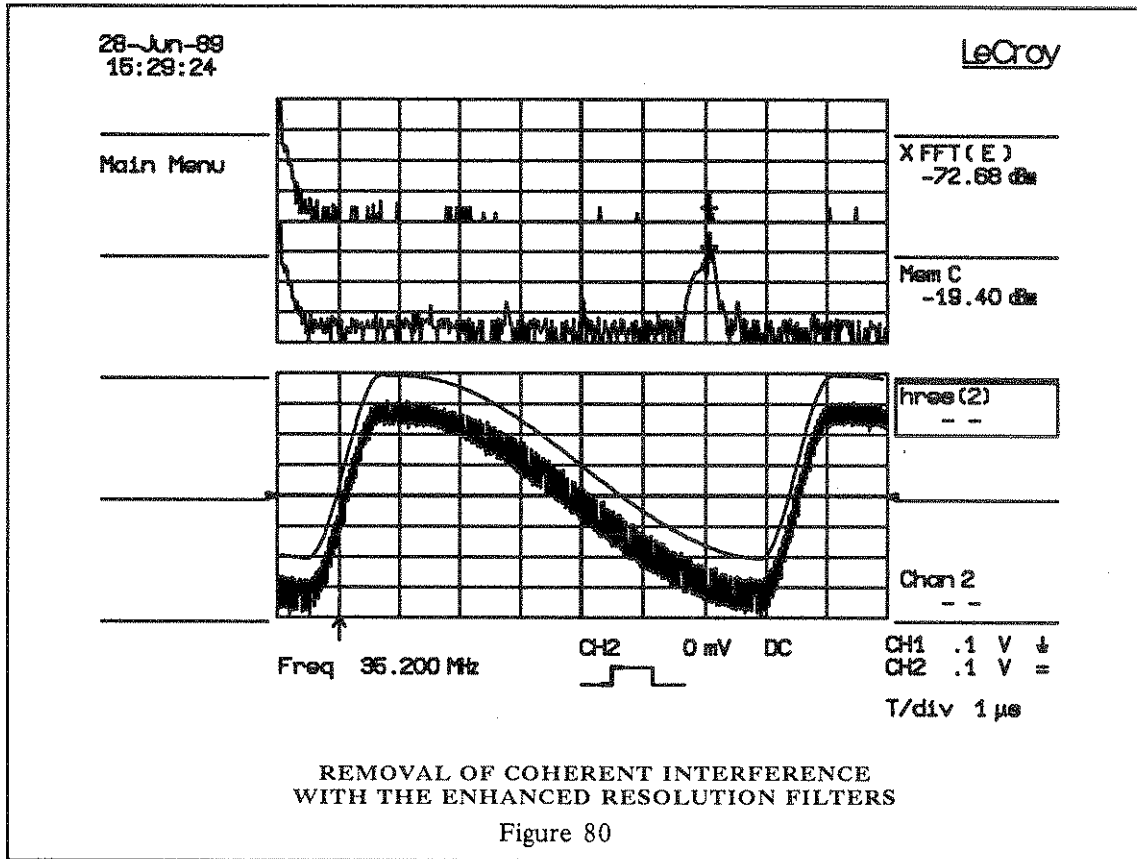

Figure 80 shows the effect of enhanced resolution filtering on a low-frequency signal which has high-frequency interference. The lower grid shows two traces. The bottom one is the original trace with high-frequency interference. The trace above is the same signal after the 2.5-bit resolution enhancement filter has removed the 35 MHz interference. The upper grid shows the Fourier transform (with 5 times horizontal expansion) of the signals in the lower grid, again with the filtered signal above. The -3 dB bandwidth of the filter in this case is 5.8 MHz, which corresponds to just over one horizontal division. It is clear that the filter has removed almost everything above 5.8 MHz, and the cursors show that the

11 Waveform Processing Option (WP01)

interfering signal has been attenuated by 53 dB. In this case averaging many traces would not have the desired effect of removing the interference because the interference is not random.

Cautionary notes

The enhanced resolution function only improves the resolution of a trace, it cannot improve the accuracy or linearity of the original quantization by the 8-bit ADC.

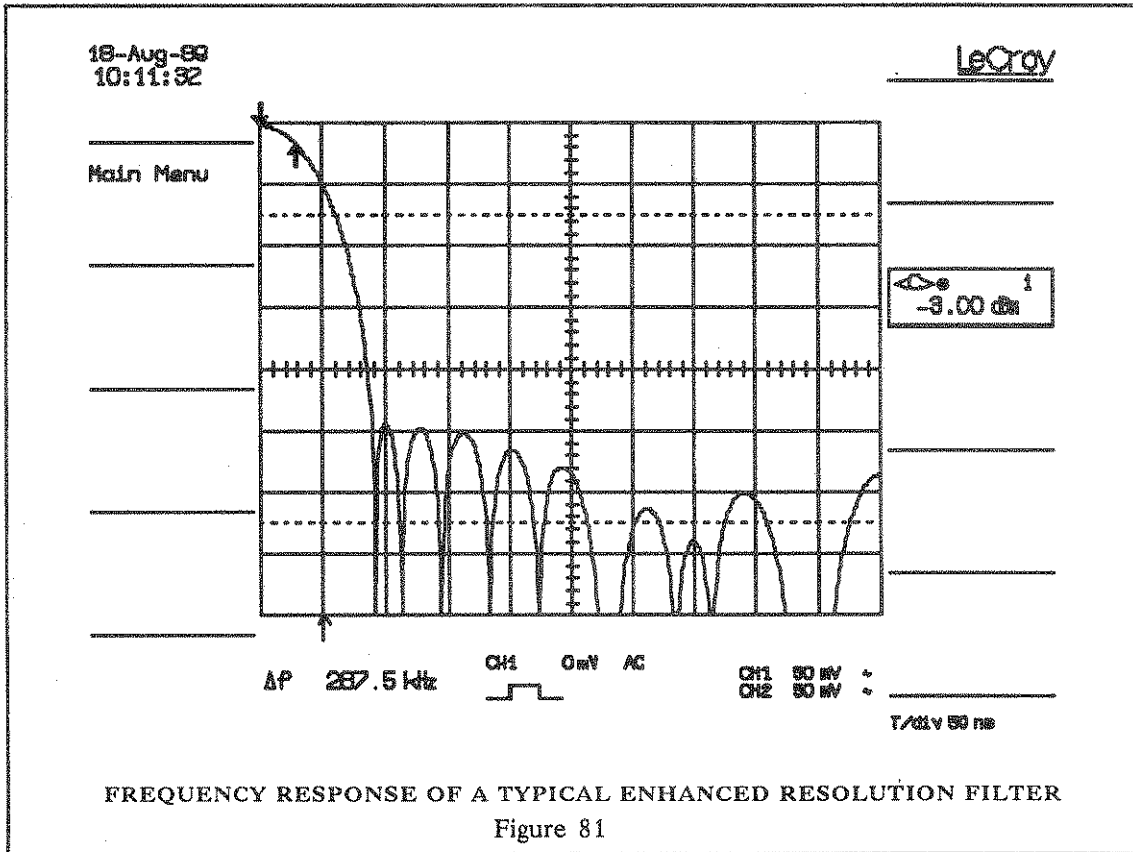

The constraint of good temporal response for the enhanced resolution filters excludes the use of maximally-flat filters. Therefore, the passband will cause slight signal attenuation for signals near the cut-off frequency. One must be aware when using these filters that the highest frequencies passed may be slightly attenuated. The frequency response of a typical enhanced resolution filter (the 2-bit enhancement filter) is shown in Figure 81. The -3 dB cut-off frequency at 5.8% of the Nyquist frequency is marked.

The filtering must be performed on finite record lengths, therefore the discontinuities at the ends of the record cause data to be corrupted at these points. These data points are not displayed by the oscilloscope and so the trace becomes slightly shorter after filtering. The number of samples lost is exactly equal to the length of the impulse response of the filter used, and thus varies between 2 and 117 samples. Because the oscilloscope has very long waveform memories this loss is not normally noticed (it is only 0.2% of a 50,000 point trace, at worst). However, it is possible to ask for filtering on a record so short that there would be no data output. The oscilloscope will not allow filtering in this case.

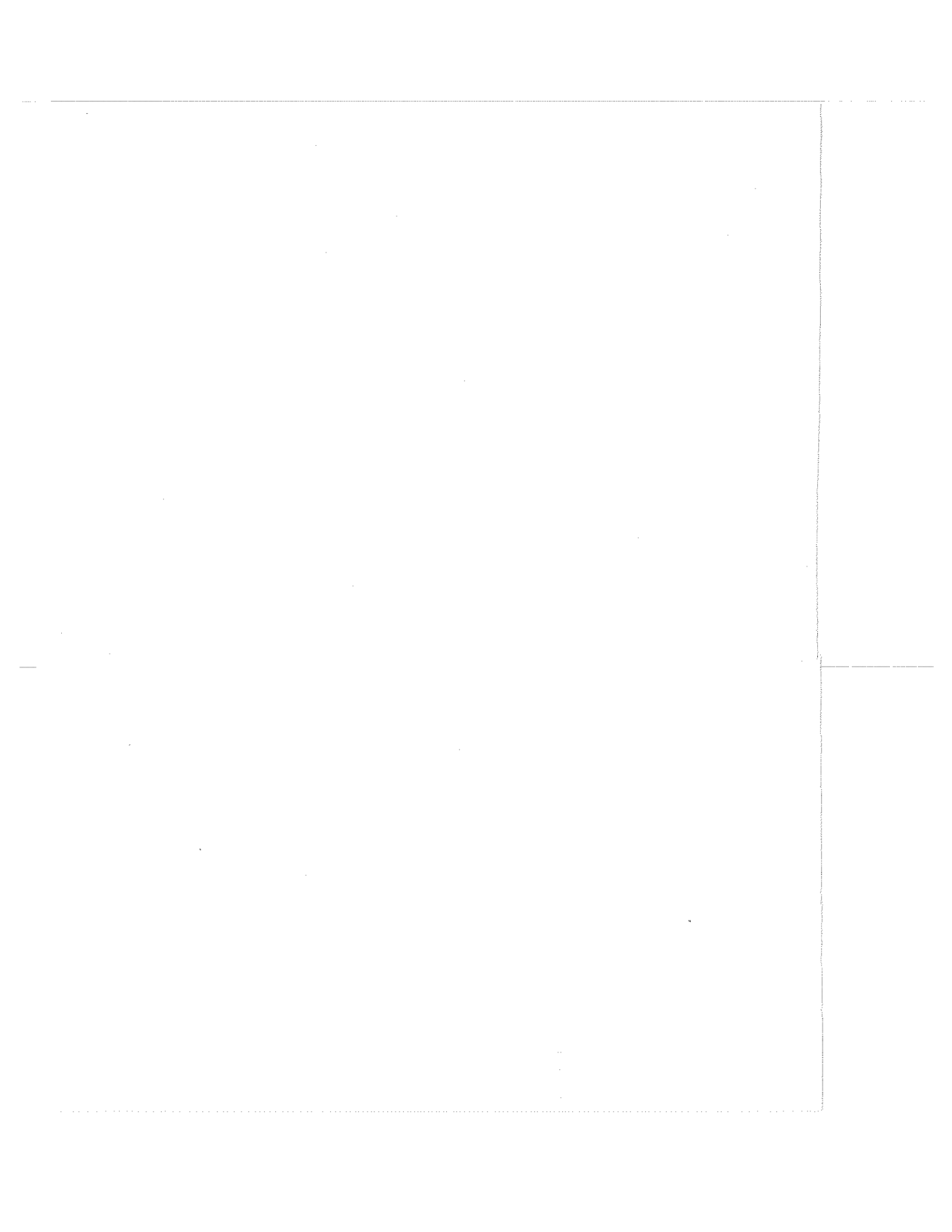

FFT OPTION (WP02)

The FFT option (WP02) adds the spectrum analysis capability to a 9420 or 9450.

Spectra of single time-domain waveforms can be computed and displayed and Power Averages can be obtained over as many as 250 spectra.

This section describes the FFT option. The remote commands for the control of FFT processing as well as waveform transfer to and from a host computer are listed in the Remote Control Manual.

FOURIER TRANSFORM

Functions E and F (buttons (52)) can be defined as the fast Fourier transform of one of the source waveforms: Expand A, Expand B (50), Memory C, Memory D (51), Function E, Function F (52), Channel 1 and Channel 2 (53).

Pressing Redefine (button (48)) while Function E or F is selected accesses the Fourier Transform menu (Figure 82).

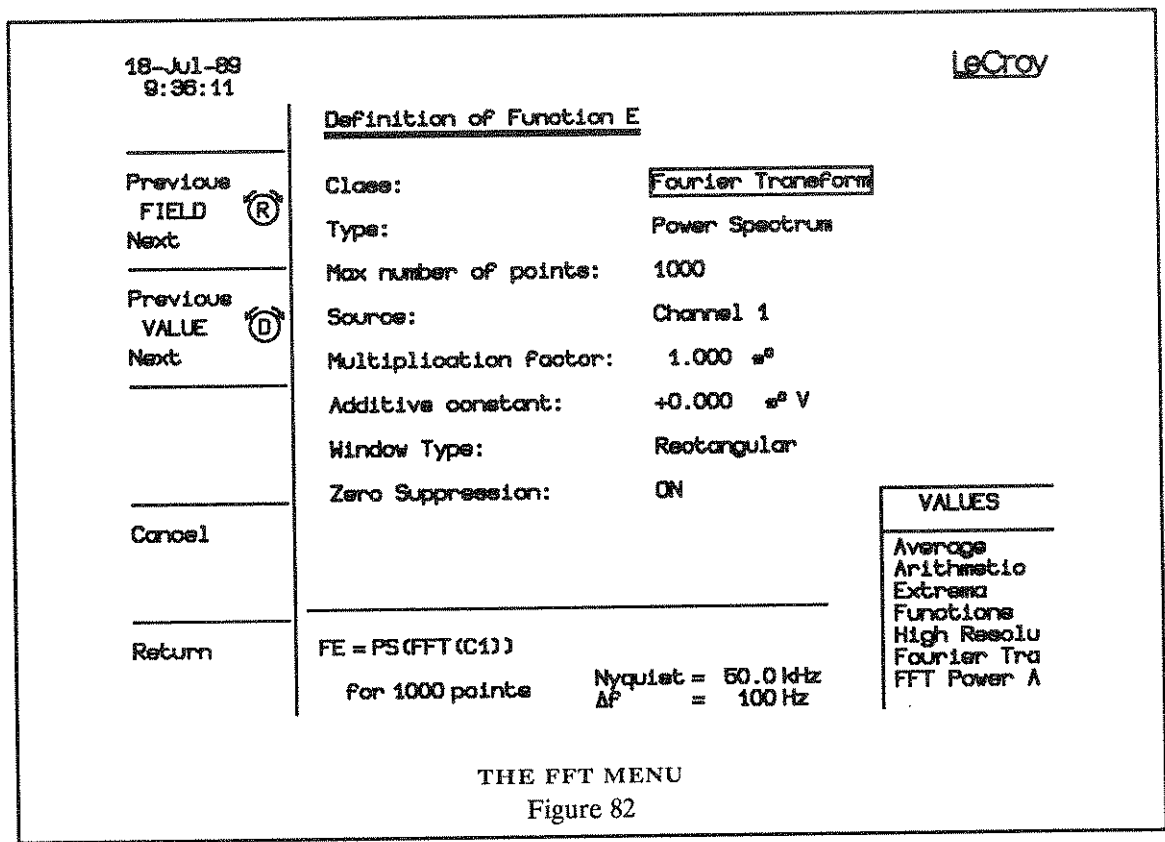

12 FFT Option (WP02)

Spectra are displayed with a linear frequency axis running from zero to the Nyquist frequency. The frequency scale factors (Hz/div) are in a 1-2-5 sequence.

The processing equation is displayed at the bottom of the Fourier Transform menu, together with three key parameters which characterize an FFT spectrum:

- 1) Transform Size N (number of input points)
- 2) Nyquist frequency
- 3) Δf (the frequency increment) between two successive points of the spectrum. These parameters are related as follows:

$$\text{Nyquist frequency} = \Delta f * N/2$$

Also note that $\Delta f = 1/T$, where T is the duration of the input waveform record (10 * time/div).

The number of output points is equal to $N/2$, where N is the number of points which were in the time-domain waveform.

The menu allows the user to set the following parameters:

Type

Power Spectrum (dBm) is the signal power (or magnitude) represented on a logarithmic vertical scale. 0 dBm corresponds to the voltage (0.316 V peak) which is equivalent to 1 mW into 50 Ω . The power spectrum is suitable for characterizing spectra which contain isolated peaks.

Power Density (dBm) is the signal power normalized to the bandwidth of the equivalent filter associated with the FFT calculation. The power density is suitable for characterizing broad-band noise.

Magnitude (same units as the input signal) is the peak signal amplitude represented on a linear scale.

Phase (degrees) is measured with respect to a cosine whose maximum occurs at the left-hand edge of the screen, at which point it has 0°; similarly, a positive-going sine starting at the left-hand edge of the screen has -90° phase.

Real, Imaginary and Real + Imaginary (same units as the input signal) represent the complex result of the FFT processing.

Max Number of Points

FFT spectra are computed over all of the source time-domain waveform. This parameter limits the number of points used for FFT processing. If the input waveform contains more points than the selected maximum, these are decimated prior to FFT processing. If the input waveform has fewer points, all points are used. The actual number of points used (**Transform Size**) is displayed at the bottom of the menu screen.

Source	Allows the user to select the source signal for FFT. Available sources are Expand A , Expand B , Memory C , Memory D , Function E , Function F , Channel 1 , and Channel 2 . The source waveform must be a time-domain waveform. The exception is a sequence waveform, which can be processed one segment at a time by expanding and then using the expanded waveform as the source.
Multiplicative Factor and Additive Constant	These parameters define a linear transformation of the input data prior to the FFT calculation.
Window Type	<p>The window type defines the bandwidth and shape of the equivalent filter associated with the FFT processing.</p> <p>The Rectangular window is normally used when:</p> <ul style="list-style-type: none"> a) the signal is a transient which is completely contained in the time-domain window b) the signal is known to have a fundamental frequency component which is an integral multiple of the fundamental frequency of the window. <p>Signals not in this class show varying amounts of spectral leakage and scallop loss, which can be corrected by using one of the other windows.</p> <p>The popular Von Hann (Hanning) and Hamming windows reduce leakage and improve amplitude accuracy. However, the frequency resolution is also reduced.</p> <p>The Flat Top window provides excellent amplitude accuracy, with moderate reduction of leakage, at the cost of frequency resolution.</p> <p>The Blackman-Harris window reduces the leakage to a minimum, with a trade-off in frequency resolution.</p> <p>Table 5 in the FFT glossary section of this chapter shows the parameters of equivalent filters.</p>
Zero Suppression	When Zero Suppression is turned ON, the DC component of the input signal is forced to zero prior to the FFT processing. This improves the amplitude resolution, especially when the input has a large DC component.

12 *FFT Option (WP02)*

FFT POWER AVERAGE

Applications

Power average is useful for the characterization of broadband noise or of periodic signals for which a stable trigger signal is not available.

Note that this type of averaging measures the total power (signal and noise) at each frequency.

A Function (E or F) can be defined as the Power Average of FFT spectra computed by the other Function.

Adjusting the FFT Power Average

Pressing Redefine (48) while Function E or F is selected accesses the Power Average menu (Figure 83), which allows the user to adjust the following parameters:

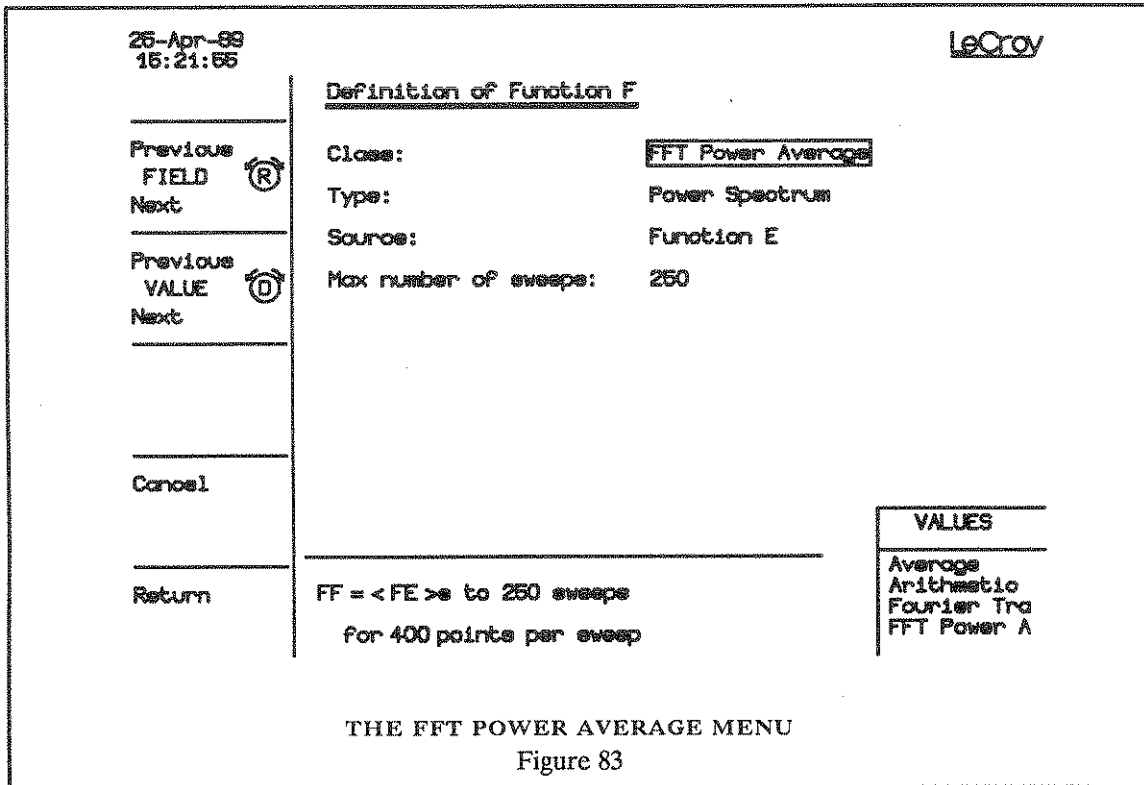

Type

Power Spectrum, Power Density and Magnitude are available. A linear frequency axis runs from 0 to the Nyquist frequency. The frequency scale factors are in a 1-2-5 sequence.

Source This must be another **Function (E or F)**, currently defined as **Fourier Transform** (any result type).

Max Number of Sweeps From 1 to 250 sweeps can be selected. Averaging stops when the max number of sweeps is reached, and continues if the number is increased.

PROCESSING FACILITIES Other waveform processing functions such as averaging and arithmetic can be applied to waveforms before the FFT processing. Time-domain averaging prior to FFT can be used if a stable trigger is available. It will reduce the random noise in the signal.

The **Time Magnifier** and **Position** controls operating on the FFT output waveforms provide horizontal expansion of up to 1000 times. The Display Control knobs provide vertical expansion (up to 10 times) and control the vertical position of the traces.

The FFT frequency range (i.e. Nyquist frequency) and the frequency resolution can be controlled as follows:

- To increase the frequency resolution, increase the length of the time-domain waveform record (i.e. use a slower time base).
- To increase the frequency range, increase the effective sampling frequency (i.e. increase the **Max number of points** or use a faster time base).

The Memory Status menu displays parameters of the waveform descriptor (number of points, horizontal and vertical scale factors and units, etc.).

CURSORS To read the amplitude and frequency of a data point, the **Absolute Time** cursor can be moved over into the frequency domain by going beyond the right-hand edge of a time-domain waveform.

The **Relative Time** cursors can be moved over into the frequency domain to simultaneously indicate the frequency difference and the amplitude difference between two points on each frequency-domain trace.

The **Absolute Voltage** cursor reads the absolute value of a point in a spectrum in the appropriate units, and the **Relative Voltage** cursors indicate the difference between two levels on each trace.

FFT INTERRUPTION (ABORT)

During FFT computation the symbol FFT is displayed in the lower left-hand corner of the screen (field (III)). Since the computation of FFT on long time-domain records may take up to 1 minute, it is possible to interrupt an FFT computation with any front-panel button or knob.

FFT ALGORITHMS

A summary of algorithms used in the 9420/50's FFT computation is given for reference.

- 1) If the **Max number of points** is smaller than the source number of points, the source waveform data are decimated prior to the FFT. The decimated data cover the full length of the source waveform.

The resulting sampling interval and the actual transform size selected provide the frequency scale factor in a 1-2-5 sequence.

- 2) The data are multiplied by the selected factor, and the selected constant is added.
- 3) If **Zero Suppression** is ON, the DC component of data is computed and is subtracted from the data.
- 4) The data are multiplied by the selected window function.
- 5) FFT is computed, using a fast implementation of the DFT (Discrete Fourier Transform):

$$X_n = \frac{1}{N} \sum_{k=0}^{k=N-1} x_k \times W^{n \times k}$$

where x_k is a complex array whose real part is the modified source time-domain waveform, and whose imaginary part is 0

X_n is the resulting complex frequency-domain waveform

$$W = e^{-(j \times 2 \times \pi / N)}$$

N is the number of points in x_k and X_n

The generalized FFT algorithm, implemented in the 9420/50, works on N which need not be a power of 2.

- 6) The resulting complex vector X_n is divided by the coherent gain of the window function, to compensate for the loss of the signal energy due to windowing. This compensation provides accurate amplitude values for isolated spectrum peaks.
- 7) The real part of X_n is symmetric around the Nyquist frequency, that is:

$$R_n = R_{N-n}$$

while the imaginary part is asymmetric, that is:

$$I_n = -I_{N-n}$$

The energy of the signal at a frequency n is distributed equally between the first and the second halves of the spectrum; the energy at frequency 0 is completely contained in the 0 term.

The first half of the spectrum (Re, Im), from 0 to the Nyquist frequency is kept for further processing and doubled in amplitude:

$$\begin{aligned} R'_n &= 2 \times R_n & 0 \leq n < N/2 \\ I'_n &= 2 \times I_n & 0 \leq n < N/2 \end{aligned}$$

- 8) The resultant waveform is computed for the spectrum type selected.

If **Real**, **Imaginary** or both are selected, no further computation is needed. The appropriate part of the complex result is given as the result (R'_n or I'_n or $R'_n + jI'_n$, as defined above).

If **Magnitude** is selected, the magnitude of the complex vector is computed as:

$$M_n = \sqrt{R_n'^2 + I_n'^2}$$

Steps (1) to (8) above lead to the following result:

An AC sine wave of amplitude 1.0 V and an integral number of periods N_p in the time window, transformed with the rectangular window, results in a fundamental peak of 1.0 V magnitude in the spectrum at frequency $N_p \times \Delta f$.

However, a DC component of 1.0 V, transformed with the rectangular window, results in a peak of 2.0 V magnitude at 0 Hz.

The waveforms for the other available types are computed as follows:

$$\begin{aligned} \text{Phase: angle} &= \arctan (I_n/R_n) & M_n > M_{\min} \\ &= 0 & M_n \leq M_{\min} \end{aligned}$$

where M_{\min} is the minimum magnitude, fixed at about 0.001 of the full scale at any gain setting, below which the angle is not well defined.

dBm Power Spectrum:

$$dBm \text{ PS} = 10 \times \log_{10} \left(\frac{M_n^2}{M_{ref}^2} \right) = 20 \times \log_{10} \left(\frac{M_n}{M_{ref}} \right)$$

where $M_{ref} = 0.316$ V (that is, 0 dBm is defined as a sine wave of 0.316 V peak or 0.224 V RMS, giving 1.0 mW into 50 Ω).

12 FFT Option (WP02)

The "dBm Power Spectrum" is the same as "dBm Magnitude", as suggested by the above formula.

dBm Power Density:

$$dBm PD = dBm PS - 10 \times \log_{10} (ENBW \times \Delta f)$$

where ENBW is the equivalent noise bandwidth of the filter corresponding to the selected window

Δf is the current frequency resolution (bin width)

- 9) The FFT Power Average takes the complex frequency-domain data R'_n and I'_n for each spectrum generated in step (7) above, and computes the square of the magnitude

$$M_n^2 = R'_n{}^2 + I'_n{}^2,$$

totals M_n^2 and counts the accumulated spectra. The total is normalized by the number of spectra and converted to the selected result type using the same formulae as are used for the Fourier Transform.

EXAMPLES OF FFT PROCESSING

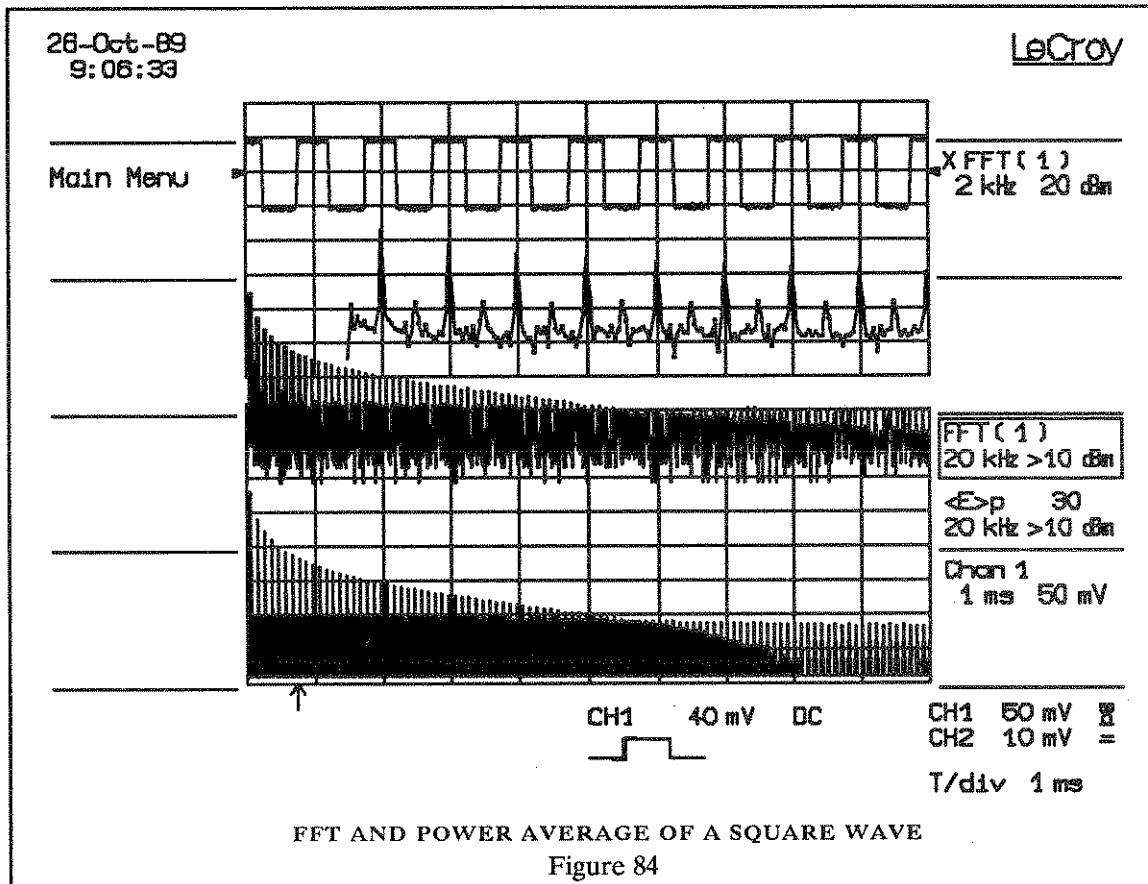

Figure 84 shows an FFT and a power average of an FFT of a square wave signal.

Channel 1 (top trace) contains a 1 kHz, 100 mVpp square wave.

Function E (third from the top) is defined as the FFT of Channel 1, with the Max number of points set to 5000, resulting in a Transform Size of 4000. The Window is Rectangular and Zero Suppression is ON. Type has been set to Power Spectrum.

Function F (bottom trace) is the Power Average of Function E and has averaged 30 spectra. Notice the lowered noise floor.

Expansion A (second from the top) shows a tenfold horizontal expansion of the FFT (Function E).

12 FFT Option (WP02)

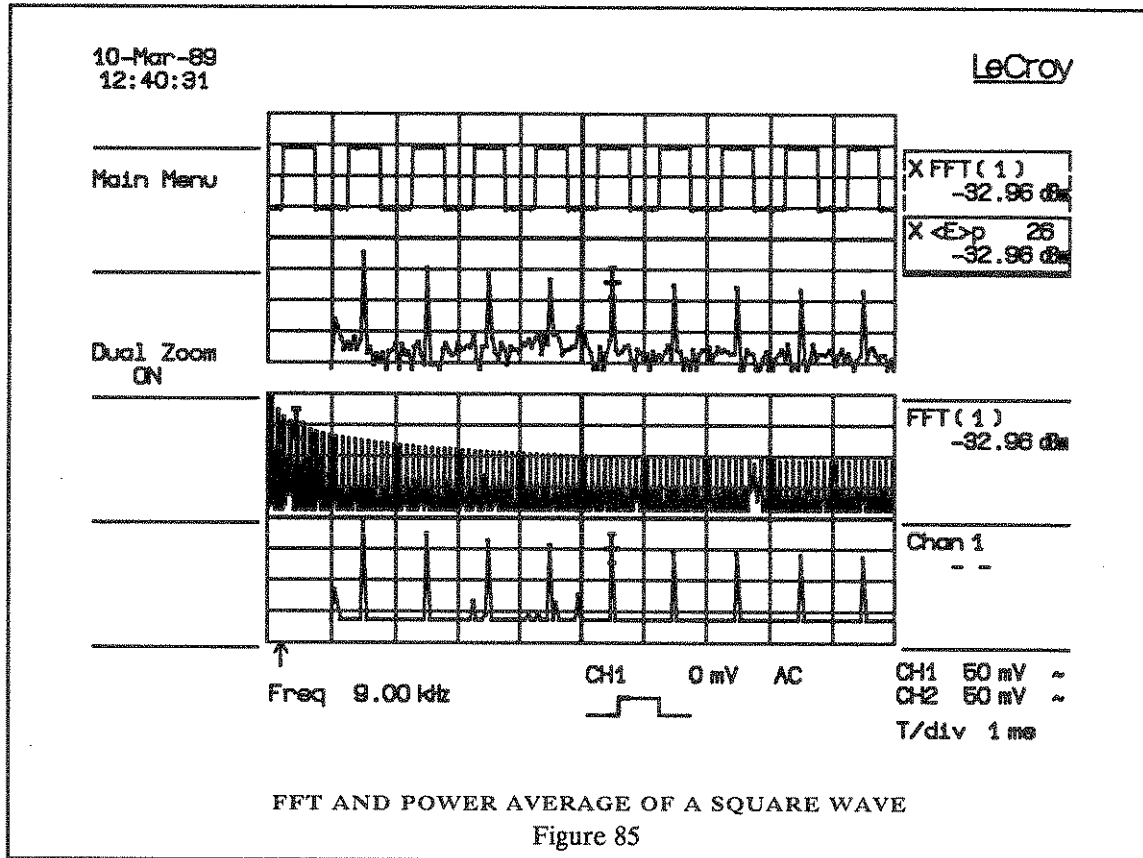

Figure 85 shows a situation similar to Figure 84.

Expansion B shows a 10× horizontal expansion of Function F, the Power Average (26 spectra accumulated and averaged).

The Absolute Time cursor is turned on and placed on the 9th harmonic of the 1 kHz square wave.

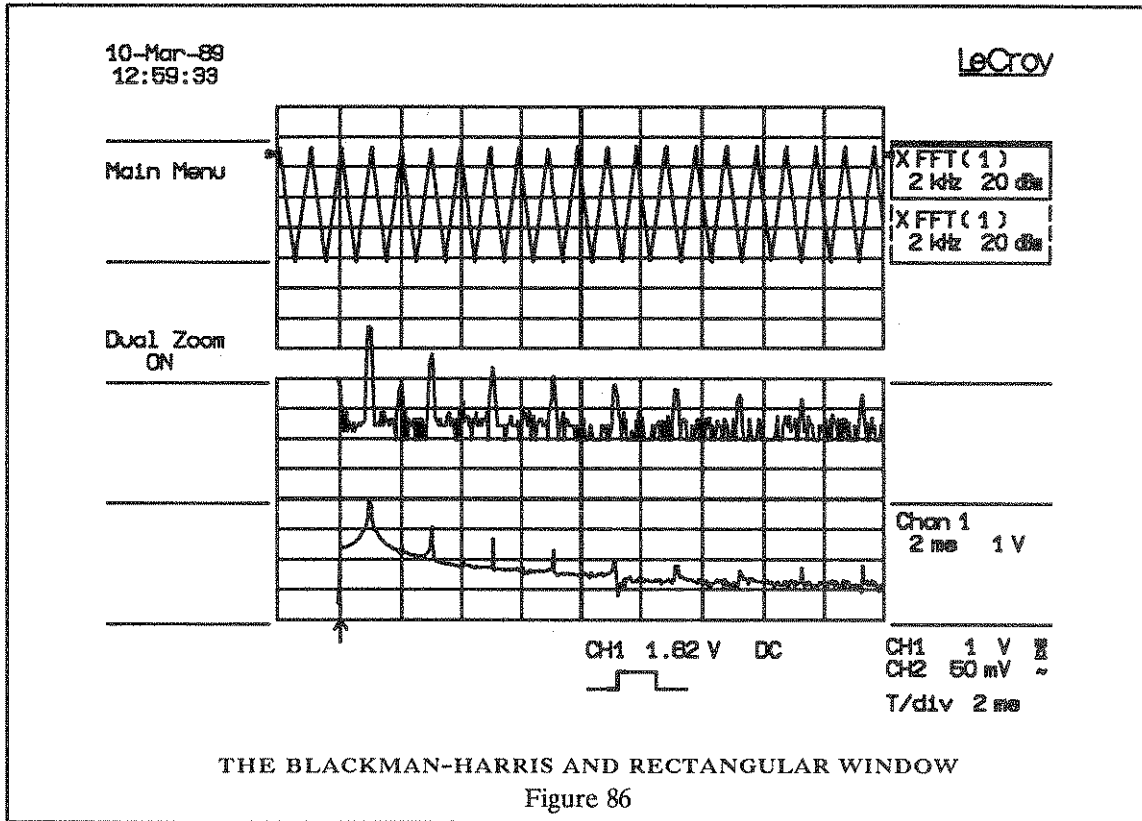

Figure 86 illustrates an example with spectral leakage and the use of an appropriate window to reduce the leakage.

Channel 1 (top trace) shows a triangular wave, of approximately 1 kHz frequency.

Expansion B (bottom trace) is an expansion of an FFT with a **Rectangular** window. Each peak, and especially the fundamental component at 1 kHz, influences the spectrum over a wide range of frequencies due to the leakage of the signal power through the side lobes of the equivalent filter.

Expansion A (middle trace) is an expansion of another FFT of the same Channel 1 waveform, defined with the **Blackman-Harris** window. The leakage is clearly reduced, but the peaks around the harmonics are wider. This reflects the increased bandwidth of the filter associated with the Blackman-Harris window.

FFT GLOSSARY

This glossary defines terms frequently used in FFT spectrum analysis and relates them to the oscilloscope.

Aliasing

If the input signal to a sampling acquisition system contains components whose frequency is greater than the Nyquist frequency (half the sampling frequency), there will be less than two samples per signal period. The result is that the contribution of these components to the sampled waveform will be indistinguishable from that of components below the Nyquist frequency. This is called aliasing.

The FFT definition menu displays the effective Nyquist frequency. The user should select the time base and transform size resulting in a Nyquist frequency higher than the highest significant component in the time-domain record.

Coherent Gain

The normalized coherent gain of a filter corresponding to each window function is 1.0 (0 dB) for a rectangular window and less than 1.0 for other windows. It defines the loss of signal energy due to the multiplication by the window function. In the 9420/50 this loss is compensated. Table 5 lists the values for the windows implemented.

ENBW (Equivalent Noise Bandwidth)

For a filter associated with each frequency bin, ENBW is the bandwidth of an equivalent rectangular filter (having the same gain at the center frequency) which would collect the same power from a white noise signal. In Table 5, ENBW is listed for each window function implemented and is given in bins.

Window type	Highest side lobe (dB)	Scallop loss (dB)	ENBW (bins)	Coherent gain (dB)
Rectangular	- 13	3.92	1.0	0.0
von Hann	- 32	1.42	1.5	- 6.02
Hamming	- 43	1.78	1.37	- 5.35
Flat-Top	- 44	0.01	2.96	-11.05
Blackman-Harris	- 67	1.13	1.71	- 7.53

Window Frequency-domain Parameters
Table 5

Filters	<p>Computing an N-point FFT is equivalent to passing the time-domain input signal through N/2 filters and plotting their outputs against the frequency. The spacing of filters is $\Delta f = 1/T$ while the bandwidth depends on the window function used (see Frequency Bins below).</p>
Frequency Bins	<p>The FFT algorithm takes a discrete source waveform, defined over N points, and computes N complex Fourier coefficients, which are interpreted as harmonic components of the input signal.</p> <p>For a real source waveform (imaginary part equals 0), there are only N/2 independent harmonic components.</p> <p>An FFT corresponds to analyzing the input signal with a bank of N/2 filters, all having the same shape and width, and centered at N/2 discrete frequencies. Each filter collects the signal energy that falls into the immediate neighborhood of its center frequency, and thus it can be said that there are N/2 "frequency bins".</p> <p>The distance, in Hz, between the center frequencies of two neighboring bins is always:</p> $\Delta f = 1/T$ <p>where T is the duration of the time-domain record in seconds.</p> <p>The width of the main lobe of the filter centered at each bin depends on the window function used. The rectangular window has a nominal width at 1.0 bin. Other windows have wider main lobes (see Table 5).</p>
Frequency Range	<p>The range of frequencies computed and displayed in the 9420/50 is 0 Hz (displayed at the left-hand edge of the screen) to the Nyquist frequency (displayed at the right-hand edge of the screen).</p>
Frequency Resolution	<p>In a simple sense, the frequency resolution is equal to the bin width, Δf. That is, if the input signal changes its frequency by Δf, the corresponding spectrum peak will be displaced by Δf. For smaller changes of frequency, only the shape of the peak will change.</p> <p>However, the effective frequency resolution (i.e. the ability to resolve two signals whose frequencies are almost the same) is further limited by the use of window functions. The ENBW value of all windows other than the rectangular is greater than Δf, i.e. greater than the bin width. Table 5 lists the ENBW value for the windows implemented.</p>
Leakage	<p>Observe the power spectrum of a sine wave having an integral number of periods in the time window (i.e. the source frequency equals one of the bin frequencies) using a rectangular window.</p>

The spectrum contains a sharp component whose value reflects accurately the source waveform's amplitude. For intermediate input frequencies this spectral component has a lower and broader peak.

The broadening of the base of the peak, stretching out into many neighboring bins is termed the leakage. It is due to the relatively high side lobes of the filter associated with each frequency bin.

The filter side lobes and the resulting leakage are reduced when one of the available window functions is applied. The best reduction is provided by the **Blackman-Harris** and the **Flat Top** windows. However, this reduction is offset by a broadening of the main lobe of the filter.

Numbers of Points

FFT is computed over the number of points (**Transform Size**) whose upper bounds are the source number of points and the **Max number of points** selected in the Fourier Transform menu. The effective transform size (number of points input to FFT) N is displayed at the bottom of the menu.

FFT generates spectra having $N/2$ output points.

Nyquist Frequency

The Nyquist frequency is equal to one half of the effective sampling frequency (after the decimation), i.e. $\Delta f \times N/2$.

The value of Nyquist frequency is displayed at the bottom of the Fourier Transform menu.

Picket Fence Effect

If a sine wave has a whole number of periods in the time domain record, the power spectrum obtained with a rectangular window will have a sharp peak, corresponding exactly to the frequency and amplitude of the sine wave. On the other hand, if a sine wave does not have a whole number of periods in the record, the spectrum peak obtained with a rectangular window will be lower and broader.

The highest point in the power spectrum can be 3.92 dB lower (1.57 times) when the source frequency is halfway between two discrete bin frequencies. This variation of the spectrum magnitude is called the picket fence effect (the loss is called the scallop loss).

All window functions compensate this loss to some extent, but the best compensation is obtained with the flat top window (see Table 5).

Power Spectrum The power spectrum (V^2) is the square of the magnitude spectrum.

The power spectrum is displayed on the dBm scale, with 0 dBm corresponding to $V_{ref}^2 = (0.316 V_{peak})^2$, where V_{ref} is the peak value of the sinusoidal voltage which is equivalent to 1 mW into 50Ω .

Power Density Spectrum The power density spectrum (V^2/Hz) is the power spectrum divided by the equivalent noise bandwidth of the filter, in Hz.

The power density spectrum is displayed on the dBm scale, with 0 dBm corresponding to (V_{ref}^2/Hz).

Sampling Frequency The time-domain records are acquired at sampling frequencies which depend on the selected time base (consult the sampling rate tables in Section 6).

Before the FFT computation, the time-domain record may be decimated. If the selected maximum number of points is lower than the source number of points, the effective sampling frequency is reduced.

The effective sampling frequency equals twice the Nyquist frequency (displayed in the Fourier Transform menu).

Scallop Loss Loss associated with the picket fence effect (listed in Table 5 for windows implemented).

Window Functions All available window functions belong to the sum of cosines family with one to three non-zero cosine terms:

$$w_k = \sum_{m=0}^{m=M-1} a_m \cos \left(\frac{2 \pi k}{N} m \right) \quad 0 \leq k < N$$

- where $M = 3$ is the maximum number of terms
- a_m are the coefficients of the terms
- N is the number of points of the decimated source waveform
- k is the time index

Table 6 lists the coefficients a_m .

The window functions, seen in the time domain are symmetric around the point $k = N/2$, (mid-screen on the oscilloscope).

12 *FFT Option (WP02)*

Window type	a0	a1	a2
Rectangular	1.0	0.0	0.0
von Hann	0.5	-0.5	0.0
Hamming	0.54	-0.46	0.0
Flat-Top	0.281	-0.521	0.198
Blackman-Harris	0.423	-0.497	0.079

Coefficients of Window Functions
Table 6

ERROR MESSAGES

For some combinations of source waveform properties and processing functions, one of the following error messages may be displayed at the top of the screen:

Incompatible input record type

FFT is not defined on a sequence mode waveform. However, the FFT of a single segment of a sequence is available by selecting an expansion as the FFT source signal. FFT power average is defined only on a Function defined as FFT.

Horizontal units don't match

FFT of a frequency-domain waveform is not available.

FFT source data zero filled

If there are invalid data points in the source waveform (at the beginning or at end of the record), these are replaced by zeros before FFT processing.

FFT source data over/underflow

The source waveform data has been clipped in amplitude, either in the acquisition (gain too high or inappropriate offset) or in previous processing. The resulting FFT contains harmonic components which would not be present in the unclipped waveform.

The settings defining the acquisition or processing should be changed to eliminate the over/underflow condition.

Circular computation

A Function definition is circular (i.e. the Function is its own source, indirectly via another Function or Expansion). One of the Definitions should be changed.

REFERENCES

Bergland, G. D., "A Guided Tour of the Fast Fourier Transform", IEEE Spectrum, July 1969, pp. 41 - 52.

A general introduction to FFT theory and applications.

Harris, F. J., "On the Use of Windows for Harmonic Analysis with the Discrete Fourier Transform", Proceedings of the IEEE, vol 66, No 1, January 1978, pp. 51 - 83.

Classical paper on window functions and their figures of merit, with many examples of windows.

Brigham, E. O., "The Fast Fourier Transform", Prentice Hall, Inc., Englewood Cliffs, N. J., 1974.

Theory, applications and implementation of FFT. Includes discussion of FFT algorithms for N not a power of 2.

Ramirez, R. W., "The FFT Fundamentals and Concepts", Prentice Hall, Inc., Englewood Cliffs, N. J., 1985.

Practice oriented, many examples of applications.

INDEX

9420

Acquisition modes, 7
Glitch Detection, 7
Random Interleaved Sampling, 32–33
Roll mode, 33
Sampling rates, 7
Single-shot acquisition, 33
Time base, 32, 34

9450

Acquisition Modes, 17
Glitch detection, 17
Random Interleaved Sampling, 35
Roll mode, 35
Sampling rates, 17
Single-shot acquisition, 35
Time base, 35, 36

A

Abridged Front-panel Status Field, 27
Abridged Trigger Field, 26
Absolute value. *See* WP01 Waveform Processing
Accuracy DC, 6, 16
Acquisition, 131
 Fast repetitive signals, 135–137
 Sequence, 42–43, 140, 143
 Single-shot, 137–139
 Slow signals, 139–140
Aliasing, 196
Arithmetic, 11, 21
 See also WP01 Waveform Processing
 Addition/subtraction, 50–51
Assistance, 1
Automatic Calibration, 5, 12, 15, 22, 161

Automatic Setup, 11, 21, 63, 132

B

Bandwidth Limiter, 37
Batteries, 12, 22
Bi-level Trigger, 9, 19, 91–93

C

Calibration, Automatic, 5, 12, 15, 22, 161
Connectors
 Accessory control, 129
 Accessory power, 127, 128
 External CK input, 129
 Sampling CK output, 129
 Trigger out, 129
 Trigger veto, 129
Continuous Average. *See* WP01 Waveform Processing
Continuous Sequence Mode, 87
Cursors, 10, 20, 51–55
 FFT analysis, 189
 Time, 53–56
 Voltage, 51–53
 XY mode, 83
Customer Service, 1–2

D

Derivative. *See* WP01 Waveform Processing
Display, 44–45
Display Resolution, 10, 20
Displayed Trace Field, 27
Dual Grid, 25, 51, 134
Dual Zoom Expansion, 47–49, 148–151

E

ENBW – Equivalent Noise Bandwidth, 196
Enhanced Resolution. *See* WP01 Waveform Processing
Exponential. *See* WP01 Waveform Processing
External Clock Input, 7, 17, 87, 129
External Time-base Control, 87
Extrema. *See* WP01 Waveform Processing

F

Fast Fourier Transform. *See* WP02 FFT Processing
FASTGLITCH, 91, 105
FFT Algorithms. *See* WP02 FFT Processing
FFT Power Average. *See* WP02 FFT Processing
FIELDLOCK, 124
Functions. *See* WP01 Waveform Processing
Fuses, 127

H

Hard Copies, 10, 20, 77–79
HF Trigger Coupling, 38
Hold-off by Number of Events, 102–104
Hold-off by Time, 101–102
Hold-off by Time or Number of Events, 90, 100–103

I

Integral. *See* WP01 Waveform Processing
Intensity, 51
Interval Width Trigger, 90–91, 107–110

L

Logarithm. *See* WP01 Waveform Processing

M

Maintenance, 1
Memory Status Menu, 66–70, 146
Menu Field, 26
Message Field, 28

N

Nyquist Frequency, 198

P

Panel Status Menu, 64–66, 146
Pattern Trigger, 9, 19, 91–93
Picket Fence Effect, 198
Power Density Spectrum, 199
Power Spectrum, 199
Probe Calibrator, 12, 22, 132
 Check, 135
 Connection, 131
 Specifications, 37
Pulse Parameters, 11, 21, 56–61
 Information and warning symbols, 62
 Time measurements, 60–61
 Voltage measurements, 59–60
Pulse Width Trigger, 90–91, 104–107

R

RAN – Return Authorization Number, 2
Random Interleaved Sampling, 32–33, 35
Real-time Clock Field, 26
Recalling Front-panel Setups, 72–75, 144
Recalling Waveforms, 145
Remote Control, 6, 11–12, 16, 21–22

Index

Remote Control and Interruption, 63
Reset, 130
Return Procedure, 2
RS-232-C Setup, 80-81

S

Safety Information, 23
Sampling Clock Output, 7, 17, 129
Sampling Frequency, 199
Saving Front-panel Setups, 72-75, 144
Screen Dump button, 51
Sensitivity (Volts/div), 29-32
Service Procedure, 2
Signal Coupling, 29
SMART Trigger Menu, 97-98
Special Modes, 86-87
 Continuous sequence mode, 87
 External time-base control, 87
Specifications, 6, 16
 Bandwidth, 6, 16
 Trigger, 8, 18
 FASTGLITCH, 9, 19
 SMART, 8, 18
 Pattern, 9, 19
 State-qualified, 9, 19
 Time/Event-qualified, 9, 19
 TV, 9-10, 19-20
Square. *See* WP01 Waveform Processing
Square Root. *See* WP01 Waveform Processing
State-qualified Trigger, 9, 19, 94
Storing Waveforms, 85, 145-146
Summed Average, 11, 21
 See also WP01 Waveform Processing

T

Time and Frequency Field, 26
Time Setup Menu, 81
Time/Event Qualified Trigger, 9, 19, 95
Trigger, 4-5, 14-15
 Out, 8, 18, 129
 SMART
 Applications, 89-94
 Hold-off, 90
 Pattern, 91-93
 State-qualified, 94
 Time/Event qualified, 95
 TV trigger, 96
 Width-based triggering, 90-91
 Bi-level, 9, 19, 114-115
 Pattern, 111-115
 Single-source, 100-111
 State-qualified, 116-118
 Time/events qualified, 119-122
 Status, 43
 Veto, 8, 18, 129-130
Trigger Controls, Standard, 37
 Coupling, 38-39
 HF, 38
 Delay, HF, 39
 Level, 39-40
 Mode, 40-43
 Slope, 40
 Sources, 38
Trigger Delay Field, 26
Trigger Graphics, 98-99
Trigger Symbols, 43, 98-99
Trigger Time Stamps, 70-72
TV Trigger, 9, 19, 96
 FIELDLOCK, 124
 Trigger on a particular field, 9-10, 19-20, 124
 Trigger on a particular line, 9, 19, 124
 Trigger on any line, 9, 19, 124

V

Voltage, Operating, 23, 127

W

Warranty, 1

Waveform Expansion, 45, 146

Waveform Processing, 153–154

See also WP01 Waveform Processing

Arithmetic, 153–154

Addition, 153

Identity, 51

Negation, 51, 153–154

Averaging, summed, 50, 154

Width-based Triggers, 90–91

Interval width, 90–91

Pulse width, 90–91

WP01 Waveform Processing

Arithmetic, 168–169

Continuous averaging, 166–168

Extrema, 169–171

Functions, 171–172

Absolute value, 171–172

Derivative, 171–172

Exponential, 171–172

Integral, 171–172

Logarithm, 171–172

Square, 171–172

Square root, 171–172

Enhanced resolution, 172–183

Summed average, 164–166

WP02 FFT Processing

Cursors, 189

Fast Fourier Transform, 185–188

FFT algorithms, 190–192

FFT examples, 193

FFT power average, 188–189

X

XY Display, 82–84

Cursor control X/Y, 83–84

Cursors, 83–84

Reference point, 84

Selecting traces, 83

ADDRESSES

US SALES OFFICES

800-5-LeCroy (automatically connects you to your local sales office)

WORLDWIDE

Argentina: Search SA, (01) 394-5882

Australia: Scientific Devices Pty.Ltd,
(03) 579-3622

Austria: Dewetron Elek. Messgeräte GmbH,
(0316) 391804

Benelux: LeCroy B.V., 31-4902-89285

Brazil: A. Santos, (021) 233 5590

Canada: Rayonics, W. Ontario:
(416) 736-1600
Rayonics, E. Ontario/Manitoba:
(613) 521-8251
Rayonics, Quebec:
(514) 335-0105
Rayonics, W. Canada:
(604) 293-1854

Denmark: Lutronic, (42) 459764

Finland: Labtronic OY, (90) 847144

France: LeCroy Sarl (1) 69073897

Germany: LeCroy GmbH, (06221) 49162
(North) (0405) 42713

Greece: Hellenic S/R Ltd., (01) 721 1140

India: Electronic Ent., (022) 4137096

Israel: Ammo, (03) 453157

Italy: LeCroy S.r.l., Roma (06) 302-9646
Milano (02) 2940-5634
(02) 204 7082

Japan: Toyo Corp., (03) 279 0771

Korea: Samduk Science & Ind., Ltd.:
(02) 468 04914

Mexico: Nucleoelectronica SA:
(905) 593 6043

New Zealand: E.C. Gough Ltd.,
(03) 798-740

Norway: Avantec A/S, (02) 630520

Pakistan: Electronuclear Corp.,
(021) 418087

Portugal: M.T. Brandao, Lta.,
(02) 691116

Singapore: Singapore Electronics and
Eng. Ltd., (065) 481 8888

Spain: Anadig Ingenieros SA,
(01) 433 2412

Sweden: MSS AB, (0764) 68100

Switzerland: LeCroy S.A.
(022) 719 21 11

Taiwan: Topward El. Inst., Ltd.,
(02) 601 8801

Thailand: Measuretronix Ltd.,
(02) 374 2516

United Kingdom: LeCroy Ltd.,
(0235) 33 114

LeCROY

CORPORATE HEADQUARTERS

700 Chestnut Ridge Road
Chestnut Ridge, NY 10977-6499
Telephone: (914) 578 6097
TWX:(710) 577-2832
Fax: (914) 425-8967

LeCROY

EUROPEAN HEADQUARTERS

2 chemin Pré-de-la-Fontaine
P.O. Box 341
1217 Meyrin 1/Geneva, Switzerland
Tel.: (022) 719 21 11 Telex: 419 058
Fax: (022) 782 39 15

