

OPERATION MANUAL

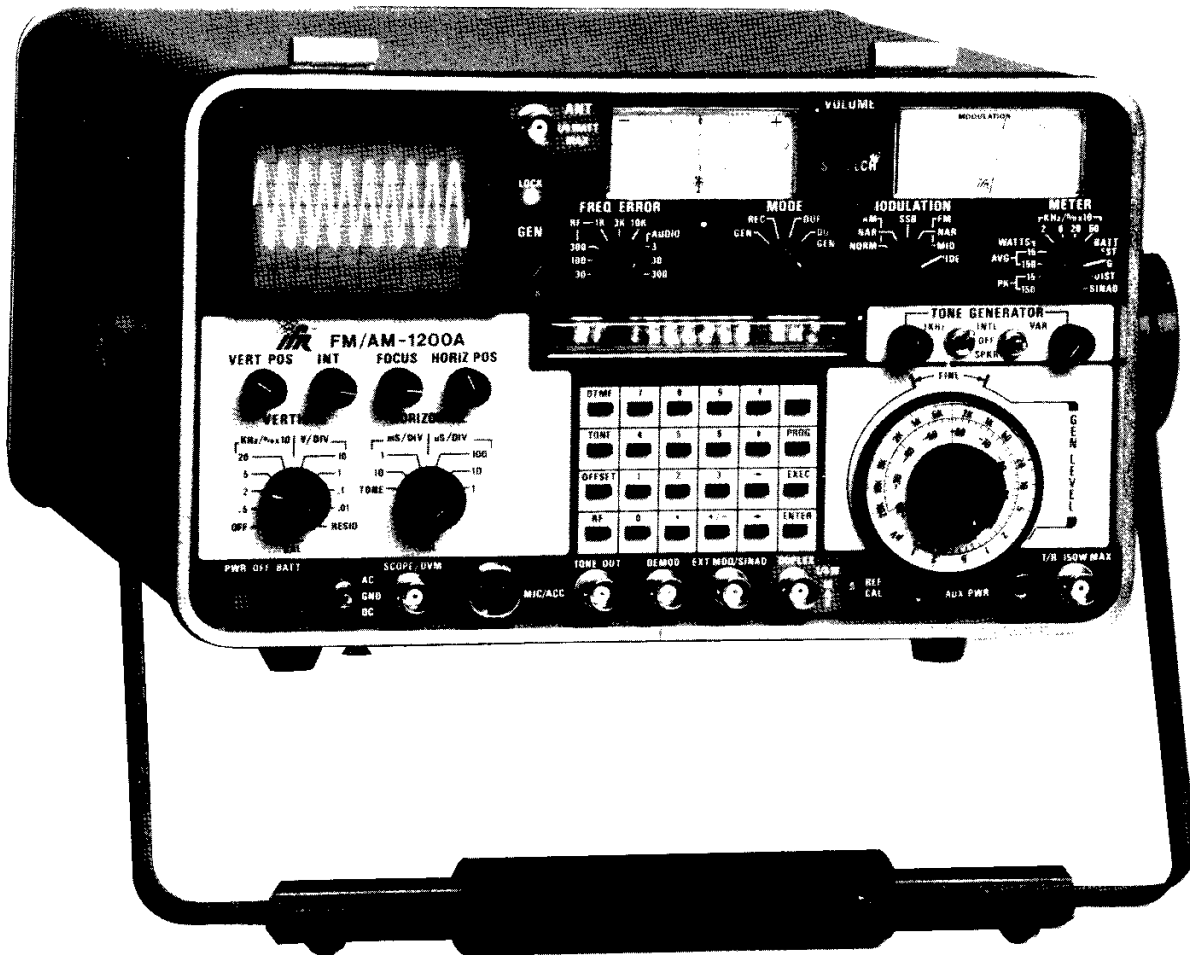

FM/AM-1200S/A COMMUNICATIONS SERVICE MONITOR



10200 West York Street/Wichita,KS 67215 U.S.A./(316) 522-4981/TWX 910-741-6952

1002-5501-000

PUBLISHED BY
IFR SYSTEMS, INC.
Wichita, Kansas

COPYRIGHT © 1988 by IFR SYSTEMS, INC.

All rights reserved. Printed in the United States of America. No part of this publication may be reproduced, stored in a retrieval system, or transmitted in any form or by any means, electronic, mechanical, photocopying, recording or otherwise without the prior permission of the publisher.

Manual Part Number: 1002-5501-000

WARNING:

HIGH VOLTAGE EQUIPMENT

THIS EQUIPMENT CONTAINS CERTAIN CIRCUITS AND/OR COMPONENTS OF EXTREMELY HIGH VOLTAGE POTENTIALS, CAPABLE OF CAUSING SERIOUS BODILY INJURY OR DEATH. WHEN PERFORMING ANY OF THE PROCEDURES CONTAINED IN THIS MANUAL, HEED ALL APPLICABLE SAFETY PRECAUTIONS.

RESCUE OF SHOCK VICTIMS

- 1. DO NOT ATTEMPT TO PULL OR GRAB THE VICTIM**
- 2. IF POSSIBLE, TURN OFF THE ELECTRICAL POWER.**
- 3. IF YOU CANNOT TURN OFF ELECTRICAL POWER, PUSH, PULL OR LIFT THE VICTIM TO SAFETY USING A WOODEN POLE, A ROPE OR SOME OTHER DRY INSULATING MATERIAL.**

FIRST AID

- 1. AS SOON AS VICTIM IS FREE OF CONTACT WITH SOURCE OF ELECTRICAL SHOCK, MOVE VICTIM A SHORT DISTANCE AWAY FROM SHOCK HAZARD.**
- 2. SEND FOR DOCTOR AND/OR AMBULANCE.**
- 3. KEEP VICTIM WARM, QUIET AND FLAT ON HIS/HER BACK.**
- 4. IF BREATHING HAS STOPPED , ADMINISTER ARTIFICIAL RESUSCITATION. STOP ALL SERIOUS BLEEDING.**

CAUTION

INTEGRATED CIRCUITS AND SOLID STATE DEVICES SUCH AS MOS FET'S, ESPECIALLY CMOS TYPES, ARE SUSCEPTIBLE TO DAMAGE BY ELECTROSTATIC DISCHARGES RECEIVED FROM IMPROPER HANDLING, THE USE OF UNGROUNDED TOOLS, AND IMPROPER STORAGE AND PACKAGING. ANY MAINTENANCE TO THIS UNIT MUST BE PERFORMED WITH THE FOLLOWING PRECAUTIONS:

1. BEFORE USING IN A CIRCUIT, KEEP ALL LEADS SHORTED TOGETHER EITHER BY THE USE OF VENDOR-SUPPLIED SHORTING SPRINGS OR BY INSERTING LEADS INTO A CONDUCTIVE MATERIAL.
2. WHEN REMOVING DEVICES FROM THEIR CONTAINERS, GROUND THE HAND BEING USED WITH A CONDUCTIVE WRISTBAND.
3. TIPS OF SOLDERING IRONS AND/OR ANY TOOLS USED MUST BE GROUNDED.
4. DEVICES MUST NEVER BE INSERTED INTO NOR REMOVED FROM CIRCUITS WITH POWER ON.
5. PC BOARD, WHEN TAKEN OUT OF THE SET, MUST BE LAID ON A GROUNDED CONDUCTIVE MAT OR STORED IN A CONDUCTIVE STORAGE BAG.

NOTE

Remove any built-in power source, such as a battery, before laying PC Boards on conductive mat or storing in conductive bag.

6. PC BOARDS, IF BEING SHIPPED TO THE FACTORY FOR REPAIR, MUST BE PACKAGED IN A CONDUCTIVE BAG AND PLACED IN A WELL-CUSHIONED SHIPPING BOX.

LIST OF EFFECTIVE PAGES

The manual pages listed below are identified by revision number. Those pages affected by the current change or revision are so identified by the current revision number and an asterisk (*).

Original	0	March 1, 1986
Revision	1	September 22, 1986
Revision	2	June 22, 1987
Revision	3	September 15, 1987
Revision	4	April 15, 1988
Revision	5	November 1, 1988
Revision	6	November 15, 1989
Revision	7	April 17, 1990
Revision	8	September 1, 1991

TOTAL NUMBER OF PAGES IN THIS MANUAL IS 288;
CONSISTING OF THE FOLLOWING:

Pg. No.	Change No.	Pg. No.	Change No.
Title Page.....	0	4-8 thru 4-11.....	2
Copyright Page.....	4	4-12.....	3
Warning Page.....	0	4-13 thru 4-14....	2
Caution Page.....	0	4-15.....	0
*A	8	4-16.....	2
*B	8	4-17 thru 4-17a ..	5
i	0	4-17b Blank	2
ii	2	4-18.....	2
iii thru xii	6	4-19 thru 4-21....	0
1-1 thru 1-3	5	4-22 thru 4-24a ..	2
1-4 Blank.....	2	4-24b Blank	2
2-1	2	4-25.....	2
2-2 thru 2-4	5	4-26.....	0
2-5	2	4-27 thru 4-29....	2
2-6	5	4-30.....	6
3-1 Blank.....	0	4-31 thru 4-33....	5
3-2	5	4-34 thru 4-35....	2
3-3	6	4-36 thru 4-39....	5
3-4	0	4-40.....	6
3-5 thru 3-7	4	4-41.....	4
3-8	0	4-42 thru 4-43....	2
3-9	2	4-43a thru 4-43c .	5
3-10.....	0	4-43d	2
3-11.....	3	4-44.....	2
3-12.....	5	4-45 thru 4-46....	5
3-13.....	2	4-47 thru 4-48....	2
3-14.....	5	4-49 thru 4-50....	5
4-1	5	4-51 thru 4-52....	2
4-7	0	5-1 thru 5-2	4

LIST OF EFFECTIVE PAGES

Pg. No.	Change No.
5-3	2
5-4	6
5-5 thru 5-8	5
5-9 thru 5-10	6
5-11 thru 5-15	5
5-15a thru 5-15b	5
5-15c	6
5-15d Blank	5
5-16 thru 5-18	5
5-18	7
5-19	4
5-20 thru 5-24	5
*5-25	8
5-26 thru 5-27	3
5-28 thru 5-40	5
*5-41 thru 5-60	8
*5-60a thru 5-60d	8
5-61 thru 5-62	7
5-63 thru 5-68	6
5-69 thru 5-70	7
5-71	6
5-72	7
5-73 thru 5-76	6
5-77	7
5-78	6
5-79 thru 5-81	7
5-82 thru 5-83	6
5-84	7
5-85	6
5-86	7
5-87 thru 5-89	6
5-90 thru 5-91	7
5-92	6
5-93 thru 5-101	7
5-102 Blank	7
A-1 thru A-5	5
A-6	7
A-7 thru A-8 Blank	4
B-1 thru B-4	5
C-1 thru C-4	2
D-1 thru D-2	0
E-1 thru E-2	0
F-1 thru F-14	5
G-1 thru G-12	5
H-1 thru H-19	7
H-20 Blank	7

PREFACE

SCOPE

This manual contains instructions for operating the FM/AM-1200S/A Communications Service Monitor. The instruction level of this manual is relatively basic and presupposes no previous experience on the part of the operator with a communication service monitor of this type. A basic understanding, however, of communication electronics and practical troubleshooting methods will be helpful. It is strongly recommended that operator be thoroughly familiar with Sections 1 through 3 of this manual before attempting to perform any operating procedures contained in Section 4.

APPLICABILITY

All information contained in this manual applies to both the FM/AM-1200S and FM/AM-1200A models, except where otherwise noted. For reasons of brevity, whenever text information is applicable to both models, the units are referenced as "FM/AM-1200S/A" (instead of FM/AM-1200S and FM/AM-1200A separately).

ORGANIZATION

The operation manual is divided into the following major sections:

SECTION 1 - INTRODUCTION

Provides a brief introduction to the FM/AM-1200S/A including purpose, functional capabilities and uses.

SECTION 2 - INSTALLATION

Provides a step-by-step procedure for setting up the FM/AM-1200S/A for operation.

SECTION 3 - DESCRIPTION OF CONTROLS, CONNECTORS & INDICATORS

Identifies and functionally describes all FM/AM-1200S/A controls, connectors and indicators.

NOTE

As an operating aid, Figure 3-1 (which locates and identifies all FM/AM-1200S/A front panel controls) has been incorporated into a fold-out page. By extending the fold-out page, the operator can easily reference any front panel control while simultaneously performing any operating procedure contained elsewhere in this manual.

SECTION 4 - OPERATION

Contains instructions for operating the FM/AM-1200S/A Keyboard and VFD. Using the Keyboard, the operator can enter data into the FM/AM-1200S/A in the following modes:

1. Direct Data Entry
2. Programmed Data Entry into Memory
3. Executed Data Entry from Memory

In addition to Keyboard operation, this section contains a selection of basic operating procedures pertaining to all major functions of the FM/AM-1200S/A.

SECTION 5 - AVAILABLE OPTIONS

Contains descriptions and operating procedures of available options to the FM/AM-1200S/A.

Useful supplementary information relating to the operation of the FM/AM-1200S/A is contained in appendices at the rear of the manual. (See Table of Contents for a detailed list of manual contents.)

TABLE OF CONTENTS

List of Effective Pages	A
Preface.....	i
List of Illustrations	ix

SECTION 1 – INTRODUCTION

Paragraph	Title	Page
1-1	General	1-1
1-2	Signal Generator/Receiver.....	1-1
1-3	FM/AM-1200S/A Capabilities	1-2
1-4	Data Display and Control Features	1-3
1-5	Generator/Receiver Support Function.....	1-3
1-6	Available Options	1-3

SECTION 2 – INSTALLATION

2-1	General	2-1
2-2	Precautions	2-1
2-3	Preparation	2-2
2-4	General Operating Data	2-5
2-5	External Power Interruption Protection	2-6

SECTION 3 – DESCRIPTION OF CONTROLS, CONNECTORS AND INDICATORS

3-1	FM/AM-1200S/A Front Panel.....	3-2
3-2	FM/AM-1200S/A Rear Panel.....	3-11
3-3	Keyboard and VFD Description	3-12
3-3-1	Function Keys	3-13
3-3-2	Instruction Keys	3-14
3-3-3	Cursor Control Keys	3-14
3-3-4	Data Entry Keys.....	3-14

SECTION 4 – OPERATION

4-1	General	4-1
4-1-1	Mini-Index of Contents Within this Section	4-1
4-2	Direct Data entry	4-2
4-2-1	Direct RF Data Entry.....	4-2

Paragraph	Title	Page
4-2-2	Direct TONE Entry	4-2
4-2-3	Direct DTMF and IMTS Entries	4-4
4-2-4	Direct OFFSET Entry	4-6
4-2-5	Meter Function	4-6
4-2-6	Set Intensity (VFD)	4-7
4-3	Programmed Data Entry into Memory	4-8
4-3-1	Programmed RF Memory	4-8
4-3-2	Programmed TONE Memory	4-10
4-3-3	Programmed DTMS and IMTS Memory	4-12
4-3-4	Programmed OFFSET Memory	4-13
4-3-5	Programmed DCS Memory	4-14
4-3-6	Programmed T SEQ Memory	4-15
4-3-7	Programmed Two Tone Memory Sequence	4-17
4-3-8	Programmed SCAN Memory	4-18
4-3-9	Programmed STEP Memory	4-19
4-4	Executed Data Entry	4-21
4-4-1	Executing RF Functions	4-21
4-4-2	Executing TONE Functions	4-21
4-4-3	Executing DTMS/IMTS (PULSE) Functions	4-22
4-4-4	Executing OFFSET Function	4-22
4-4-5	Executing SCAN Function	4-23
4-4-6	Executing DCS Function	4-23
4-4-7	Executing T SEQ Function	4-24a
4-4-8	Executing STEP (RF & TONE) Function	4-25
4-4-9	Executing Variable IMTS Audio Function	4-27
4-5	Receiver Operation	4-28
4-5-1	General	4-29
4-5-2	Basic Receiver Operation	4-30
4-5-3	Receiving AM or FM Signals (Off-the-Air)	4-31
4-5-4	Receiving SSB Signals (Off-the-Air)	4-31
4-5-5	Testing AM or FM Transmitters	4-32
4-5-6	Measuring AM or FM Transmitter Distortion	4-32

Paragraph	Title	Page
4-6	RF Signal Generator Operation (Simplex)	4-34
4-6-1	General	4-35
4-6-2	Signal Generator Operation (Simplex)	4-36
4-6-3	Generating AM or FM Modulated RF Signals	4-36
4-6-4	Externally Modulating RF Signal Generator	4-38
4-6-5	Voice Modulating RF Signal Generator	4-38
4-6-6	Variable Generate	4-39
4-6-7	Measuring UUT Receiver SINAD Sensitivity	4-39
4-7	Duplex Operation	4-40
4-7-1	General	4-41
4-7-2	Duplex Testing Using Separate Transmit/Receive Lines (Full Duplex Operation) (FM/AM-1200A Only)	4-41
4-7-3	Off-the-Air Duplex Testing (FM/AM-1200A Only)	4-42
4-7-4	Duplex Testing Using Common Transmit/Receive Line (Half-Duplex Operation) (FM/AM-1200 A Only)	4-42
4-7-5	Duplex Testing (FM/AM-1200A Only)	4-42
4-7-6	Duplex Generate Mode (FM/AM-1200A Only)	4-43
4-7-7	Selecting "Duplex High" or "Duplex Low" (FM/AM-1200S Only)	4-43a
4-7-8	Duplex Testing Methods (FM/AM-1200S Only)	4-43a
4-7-9	Duplex Test (FM/AM-1200S Only)	4-43c
4-7-10	Duplex Generate Mode (FM/AM-1200S Only)	4-43d
4-8	Oscilloscope Operation	4-44
4-8-1	General	4-45
4-8-2	External Oscilloscope Operation	4-45
4-8-3	Internal Oscilloscope Operation	4-45
4-8-4	Residual Distortion	4-46
4-8-5	Tone Generator	4-46
4-9	Spectrum Analyzer Operation (FM/AM-1200S Only)	4-47
4-9-1	General	4-47
4-9-2	Spectrum Analyzer Operation	4-49
4-10	Tone Generator Operation	4-49
4-11	Basic RS-232 Operation	4-50

Paragraph	Title	Page
4-11-1	FM/AM-1200S/A Initialization	4-50
4-11-2	RS-232 Command Procedure and Data Structure	4-51
4-11-3	Allowable RS-232 Command Formats	4-52
4-11-4	RS-232 Remote Commands	4-53

SECTION 5 -- AVAILABLE OPTIONS

5-1	General	5-1
5-2	.2 PPM Frequency Standard - Option 01	5-1
5-3	.05 PPM Frequency Standard - Option 02	5-1
5-4	Battery - Option 04	5-1
5-5	Generate Amplifier - Option 05	5-2
5-5-1	General	5-2
5-5-2	Installation	5-2
5-5-3	Operation	5-3
5-6	Microphone - Option 06	5-3
5-7	Telescoping Antenna - Option 07	5-3
5-8	Soft Padded Carrying Case - Option 09	5-3
5-9	Digital Voltmeter and DTMF Decoder - Option 10	5-4
5-9-1	General	5-4
5-9-2	Digital Voltmeter Operation	5-4
5-9-3	DTMF Decoder Operation	5-6
5-10	European Signaling (Encode/Decode) - Option 11	5-8
5-10-1	General	5-8
5-10-2	Five-Digit Signaling Format Operation (Includes CCIR, EEA, EIA, ZVEI1, ZVEI2, ZVEI3, NATEL and EURO).....	5-8
5-10-3	Programming and Executing ZVEI2 in Generate Mode	5-9
5-10-4	Executing Repeat Tones	5-10
5-10-5	Executing Five Digit Format in Receive Mode	5-11
5-10-6	Executing NATEL in Receive Mode with RF Set to 123.4567 MHz	5-12
5-10-7	5/6 Tone Signaling Format Operation.....	5-13
5-10-8	Two Tone Signaling Format Operation.....	5-14
5-10-9	Enhanced European Signaling (Encode/Decode)-Option 11 w/software Version 4.0-04 (or Higher) Installed	5-15a

Paragraph	Title	Page
5-10-10	Programming Eight-Digit Signaling Format Operation (Includes CCIR, EEA, EIA, ZVEI1, ZVEI2, ZVEI3, NATEL EURO, CCIRH, and CCIRH4).....	5-15b
5-10-11	Enhanced 5/6 Tone Format	5-15b
5-10-12	Deviation Set Select.....	5-15c
5-10-13	*G* Character Programming.....	5-15c
5-11	Tracking Generator - Option 12 (FM/AM-1200S Only).....	5-16
5-11-1	General	5-16
5-11-2	Selecting Tracking Generator Mode of Operation	5-17
5-11-3	Track Adjust	5-19
5-11-4	Variable Sweep Speed.....	5-19
5-11-5	RS-232 Commands for Tracking Generator	5-20
5-12	GPIB Operation - Option 13	5-21
5-12-1	General	5-21
5-12-2	Preparation for Using GPIB	5-21
5-12-3	FM/AM-1200S/A Initialization	5-21
5-12-4	Remote Control (GPIB) Operation	5-22
5-12-5	FM/AM-1200S/A and GPIB Message Interface Definitions ..	5-24
5-12-6	GPIB Transactions	5-25
5-12-7	ASCII Output Commands to the FM/AM-1200S/A	5-25
5-12-8	ASCII Output Command Data Format	5-26
5-12-9	Return Data Format	5-26
5-12-10	Reply Identifier	5-27
5-12-11	Allowable GPIB Command Formats.....	5-27
5-12-12	GPIB Remote Commands.....	5-29
5-13	Trunking - Option 14 (FM/AM-1200S Only).....	5-41
5-13-1	General	5-41
5-13-2	Trunking Operational Theory	5-41
5-13-3	Accessing the Trunking System.....	5-42
5-13-4	Trunking System Setup Procedure	5-48
5-13-5	Trunking System Test Procedure.....	5-49
5-13-6	Simple Encode/Simple Decode Modes and Repeater Access Test.....	5-50

Paragraph	Title	Page
5-13-7	Repeater Simulation Mode	5-55
5-13-8	Mobile Unit Simulation Mode	5-58
5-14	CELLULAR TESTING	
	AMPS: OPTION 15 (FM/AM-1200S ONLY)	
	ETACS: OPTION 16 (FM/AM-1200S ONLY)	5-61
5-14-1	GENERAL	5-61
5-14-2	INITIAL SETUP	5-62
5-14-3	Manual Mobile-to-Cell Call	5-68
5-14-4	Meter Displays During Cellular Testing	5-73
5-14-5	Manual Cellular Test SINAD Measurement	5-74
5-14-6	Check DTMF Digits During Manual Cellular Test	5-75
5-14-6a	Flash Hook Test	5-76
5-14-7	Check Voice Deviation During Manual Cellular Test	5-76
5-14-8	Terminating Manual Cellular Test	5-77
5-14-9	Manual Cell-to-Mobile Call and Auto Handoff Test	5-77
5-14-10	Supervisory Audio Tone (SAT) Measurement	5-81
5-14-11	Signal Tone Measurement	5-84
5-14-12	Manual UUT Registration	5-85
5-14-13	No-Coax Mobile-to-Cell Call	5-87
5-14-14	No-Coax Cell-to-Mobile Call	5-89
5-14-15	Cellular Auto Test Procedure	5-90
5-14-16	Error Messages	5-96
5-14-17	Test Results Review	5-97
5-14-18	RS-232 Remote Cellular Comands	5-100

APPENDICES

Appendix	Title	Page
Appendix A	Specifications	A-1
Appendix B	Table of User I/O Ports/Connectors Pin-Out Tables	B-1
Appendix C	Minimum Performance Check	C-1
Appendix D	List of Abbreviations	D-1
Appendix E	Repacking for Shipment	E-1
Appendix F	Trunking Test Systems Channel Number Transmit/Receive Frequencies	F-1
Appendix G	Cellular Channel Numbers and Frequencies (AMPS)	G-1
Appendix H	Total Access Communications System (TACS) Cellular Telephone Channel Numbers and Assigned Center Frequencies	H-1

LIST OF ILLUSTRATIONS

Figure No.	Title	Page
2-1	FM/AM-1200S/A Front Panel	2-3
2-2	FM/AM-1200S/A Rear Panel	2-4
2-3	AC Power Select Switch Location	2-5
3-1	FM/AM-1200S/A Front Panel Controls, Connectors and Indicators	3-2
3-2	Modulation Meter Scales	3-3
3-3	FM/AM-1200S/A Rear Panel Connectors	3-11
3-4	Keyboard and VFD Layout	3-12
4-1	FM/AM-1200S/A Front Panel Controls Applicable to Receiver Operation	4-28
4-2	FM/AM-1200S/A Front Panel Controls Applicable to RF Signal Generator Operation	4-34
4-3	FM/AM-1200S/A Front Panel Controls Applicable to Duplex Operation	4-40
4-4	FM/AM-1200S/A Front Panel Controls Applicable to Oscilloscope Operation	4-44
4-5	FM/AM-1200S/A Front Panel Controls Applicable to Spectrum Analyzer Operation	4-47
4-6	Typical Spectrum Analyzer Display	4-48
5-1	Generate Amplifier Installation	5-3
5-2	FM/AM-1200S/A Front Panel Controls Applicable to Digital Voltmeter Operation	5-4

Figure No.	Title	Page
5-3	FM/AM-1200S/A Front Panel Controls Applicable to DTMF Decoder Operation.....	5-6
5-4	FM/AM-1200S/A Front Panel Controls Applicable to Tracking Generator Operation	5-16
5-5	Typical Tracking Generator Display of a Notch Filter notch	5-18
5-6	Simple Handshake Sequence.....	5-46
5-7	Handoff Sequence	5-47
5-8	FM/AM-1200S Front Panel Controls Applicable to Trunking Test Operations	5-48
5-9	FM/AM-1200S Front Panel Controls Applicable to Cellular Testing Operations.....	5-61
5-9a	Manual UUT Registration Printout (AMPS)	5-86
5-10	AMPS Cellular Test Printout Form	5-98
5-11	ETACS Cellular Test Printout Form	5-99
B-1	MIC/ACC Connector Pin Identification (Front View).....	B-2
B-2	GPIB Connector	B-4
C-1	Performance Test Set-Up Diagram	C-2
E-1	Repacking for Shipment	E-2

LIST OF TABLES

Table No.	Title	Page
3-1	Modulation Select Control Positions.....	3-2
3-2	Modulation Meter Control Positions	3-3
3-3	Horizontal Sweep Selector Control Settings	3-8
4-1	Program Memory Locations	4-8
4-2	List of Current DCS Codes.....	4-24
4-3	FM/AM-1200S/A Front Panel Controls Applicable to Receiver Operation.....	4-28
4-4	Receiver Monitoring Capabilities	4-29
4-5	Modulation Select Control Positions.....	4-31
4-6	FM/AM-1200S/A Front Panel Controls Applicable to RF Signal Generator Operation	4-34
4-7	Receiver Monitoring Capabilities of Generated Output	4-35
4-8	FM/AM-1200S/A Front Panel Controls Applicable to Duplex Operation	4-40

Table No.	Title	Page
4-9	FM/AM-1200S/A Front Panel Controls Applicable to Oscilloscope Operation.....	4-44
4-10	FM/AM-1200S/A Front Panel Controls Applicable to Spectrum Analyzer Operation.....	4-47
4-11	Horizontal Sweep Selector Control (Analyzer dispersion Control) Settings	4-48
4-12	Allowable Command Formats	4-52
4-13	RS-232 Remote Commands	4-53
5-1	FM/AM-1200S/A Front Panel Controls Applicable to Digital Voltmeter Operation.....	5-4
5-2	FM/AM-1200S/A Front Panel Controls Applicable to DTMF Decoder Operation.....	5-6
5-3	Toneset Frequency Table	5-9
5-4	FM/AM-1200S/A Front Panel Controls Applicable Tracking Generator Operation	5-16
5-5	Horizontal Sweep Selector Control (Analyzer Dispersion Control) Settings and Horizontal Sweep Speed.....	5-18
5-6	Tracking Generator RS-232 Commands	5-20
5-7	IEEE 488-1978 BUS Messages	5-23
5-8	GPIB Message Definitions	5-24
5-9	GPIB Command Format	5-28
5-10	GPIB Commands	5-29
5-11	FM/AM-1200S Front Panel Controls Applicable to Trunking Test Operations	5-48
5-12	FM/AM-1200S Front Panel Controls Applicable to Cellular Testing Operations.....	5-61
5-13	RS-232 Remote Cellular Testing Commands	5-100
B-1	Table of I/O Ports	B-1
B-2	MIC/ACC Connector Pin Assignments	B-2
B-3	RS-232 Connector Pin Assignments (Standard)	B-3
B-4	RS-232 Connector Pin Assignments with Cellular Testing (Option 15) Installed.....	B-3
B-5	GPIB Connector Pin Assignments.....	B-4
F-1	Trunking Channel Low Frequency Band.....	F-1
F-2	Trunking Channel High Frequency Band	F-9

G-1 Cellular Channel Numbers and Assigned Center
Frequencies.....G-1

H-1 Total Access Communications System (TACS) and Enhanced
Total Access Communications System (ETACS) Cellular
Telephone Channel Numbers and Assigned Center
Frequencies.....H-1

SECTION 1 - INTRODUCTION

1-1 GENERAL

The FM/AM-1200S/A is a microprocessor controlled, digitally synthesized communication service monitor, which integrates the functions of several different test instruments into a single, compact and portable unit. Utilizing such features as a keyboard entry system, a Vacuum Fluorescent Display for digital readout, processor controlled memory functions, a CRT capable of displaying oscilloscope inputs and a DTMF encoder used simultaneously with the variable audio generator for audio tone encoding, the FM/AM-1200S/A incorporates the functions of the following test equipment:

Signal Generator	Frequency Error Meter
Communication Receiver	Modulation Meter
Digital Voltmeter (Option)	SINAD Meter
Oscilloscope	Audio Error Meter
1 kHz (Fixed) Tone Generator	Signal Strength Meter
Variable Tone Generator (Programmable)	DUPLEX Generator (with a selectable offset)
DTMF Encoder	Spectrum Analyzer
DTMF Decoder (Option)	(FM/AM-1200S only)
Power Meter	Tracking Generator (Option, FM/AM-1200S only)

These capabilities enable the FM/AM-1200S/A to be used in a wide range of communication test functions associated with most types of simplex and duplex transceiving equipment, including mobile telephone systems, AM/FM/SSB transceivers, CB and two-way radio systems, repeaters, etc.

1-2 SIGNAL GENERATOR/RECEIVER

The FM/AM-1200S/A Signal Generator is capable of generating modulated or unmodulated carrier signals within a range of 250 kHz to 999.9999 MHz (in 100 Hz steps), at an output level which is continuously variable from -20 to -127 dBm. The generated carrier signal may be AM or FM modulated by internal modulation signals from the FM/AM-1200S/A tone generators or by external sources applied through front panel modulation input connectors defined in Section 3 of this manual. The signal generator may also be voice-modulated and keyed through the front panel microphone input connector. All of the above described modulation sources, or any combination thereof, may be simultaneously applied to the carrier signal. During signal generator operation, signals being generated can be monitored by the FM/AM-1200S/A receiver and its associated monitoring devices.

The signal generator also features a selectable offset frequency function to permit testing of duplex equipment, which receives and transmits simultaneously on different frequencies. See paragraph 1-3 for additional information about this feature.

The FM/AM-1200S/A receiver is a triple conversion, superheterodyne receiver, capable of monitoring communication signals within a range of 250 kHz to 999.9999 MHz, in 100 Hz steps. Signals may be received "off-the-air" using an external antenna or by direct cable connection through the front panel T/R Connector. Associated receiver monitoring circuits include a frequency error meter, modulation meter, power meter, SINAD meter, signal strength meter, frequency error and demodulated audio counters, oscilloscope and spectrum analyzer (FM/AM-1200S only).

1-3 FM/AM-1200S/A CAPABILITIES

A prime feature of the FM/AM-1200S/A is the capability of testing both simplex and duplex communication equipment. Simplex operation is defined as any equipment that communicates in only one direction at a time on the same frequency, including ordinary transmit-receive or press-to-talk operation, voice operated carrier and other forms of manual or automatic switching from transmit to receive. Duplex operation is characteristic of any equipment which transmits on one frequency and receives on another frequency between two locations, such as mobile telephone systems and repeaters.

In receive mode, the FM/AM-1200S/A receiver monitors incoming signals received "off-the-air" or applied via direct cable connection through the front panel T/R Connector. In this mode, the FM/AM-1200S/A signal generator is inactive. In the generate mode, the FM/AM-1200S/A is capable of generating modulated or unmodulated carrier signals while the receiver circuits are simultaneously monitoring the generator.

In the duplex mode, the FM/AM-1200S/A has the capability of generating and receiving signals simultaneously. While the receiver section of the FM/AM-1200S/A is monitoring incoming signals transmitted by the UUT, the FM/AM-1200S/A duplex generator is simultaneously generating signals to stimulate the receiver section of the UUT. The frequency of the generated signal from the FM/AM-1200S/A can be offset up to ± 49.99 MHz from the receiving frequency in 10 kHz steps. Three methods of duplex testing are available using the FM/AM-1200S/A. They are:

- Duplex Testing using separate Transmit/Receive Lines
- Duplex Testing using one common Transmit/Receive Line
- "Off-the-air" Duplex testing

The methods of duplex testing are described in detail in Section 4.

1-4 DATA DISPLAY AND CONTROL FEATURES

Operator interaction with the FM/AM-1200S/A is facilitated through the following primary data display and control features:

A. KEYBOARD

The Keyboard provides a means of entering data into the FM/AM-1200S/A microprocessor, to control the operation of the RF Frequency or Tone Generator functions. The Keyboard is also used to address the FM/AM-1200S/A programmable functions which utilize the automatic storage, retrieval and execution capabilities of the set. All Keyboard functions are described in detail in Section 3.

B. VFD

The Vacuum Fluorescent Display (VFD) is used to display the current Keyboard operating frequencies associated with the FM/AM-1200S/A tone generator or RF Frequency functions. The VFD will display any telephone number selected during DTMF or IMTS functions (Ref. Section 3), provide a digital readout of the selected range of both the FREQ ERROR and MODULATION Meters or display Digital Voltmeter readings.

1-5 GENERATOR/RECEIVER SUPPORT FUNCTIONS

The FM/AM-1200S/A has the following additional operating functions which are primarily used to support the generate/receive capabilities of the set:

Digital Voltmeter (Option)	Fixed Tone Generator
Oscilloscope	Programmable Tone Generator
Modulation Meters	Freq Error Meter
Spectrum Analyzer (FM/AM-1200S Only)	

The application and use of these functions are described in detail in Sections 3 and 4.

1-6 AVAILABLE OPTIONS

In addition to the standard features of the FM/AM-1200S/A, several optional features are available. These include:

.05 PPM Frequency Standard	European Signaling
Generate Amplifier	(ENCODE/DECODE)
Microphone	Tracking Generator
Telescoping Antenna	General Purpose Interface
Soft Padded Carrying Case	Bus (GPIB)
Digital Voltmeter/DTMF Decode	Trunking Radio Testing
	Cellular Telephone Testing

For a more detailed description and operating procedures, turn to Section 5.

01.10.2024

1

02.10.2024

03.10.2024

04.10.2024

SECTION 2 - INSTALLATION

2-1 GENERAL

This section contains information on preparing the FM/AM-1200S/A for use, along with installation and operating precautions that will assure safe and trouble-free utilization of the unit.

2-2 PRECAUTIONS

For operator safety and to prevent possible damage to the FM/AM-1200S/A, the following operating precautions should be observed at all times.

WARNING

THE FM/AM-1200S/A CHASSIS AND CASE MUST BE CONNECTED TO ELECTRICAL GROUND. CONNECT THE FURNISHED AC POWER CORD TO A PROPERLY GROUNDING 3-PIN RECEPTACLE. THE USE OF A 3-PIN TO 2-PIN ADAPTER (PARALLEL GROUND ADAPTER OR ISOLATION PLUG) IS NOT RECOMMENDED.

CAUTION

ANTENNA CONNECTOR

THE ANT CONNECTOR IS USED FOR "OFF THE AIR" TESTING AND WITH THE OPTIONAL GENERATE AMPLIFIER ONLY. DO NOT CONNECT A TRANSMITTER TO THIS INPUT. MAXIMUM INPUT INTO THIS CONNECTOR MUST NOT EXCEED 0.25 WATT OR DAMAGE TO THE FM/AM-1200S/A WILL RESULT.

T/R CONNECTOR

DO NOT CONNECT A UUT TRANSMITTER OUTPUT TO ANY JACK OTHER THAN THE T/R CONNECTOR.

MAXIMUM "ON" TIME FOR MEASUREMENT OF UUT TRANSMITTER OUTPUT USING T/R CONNECTOR IS:

> 50 TO 150 W = 1 MINUTE "ON", 5 MINUTES "OFF".

↓

50 W = MAXIMUM CONTINUOUS

DUPLEX OUTPUT CONNECTOR

DO NOT TRANSMIT INTO THIS CONNECTOR. THIS CONNECTOR IS NOT PROTECTED FOR POWER INPUTS IN EXCESS OF 0.25 WATT.

CRT INTENSITY

DO NOT OPERATE CRT DISPLAY WITH EXCESSIVE INTENSITY.

SCOPE CONNECTOR

DO NOT APPLY MORE THAN 200 VOLTS PEAK TO PEAK TO THIS CONNECTOR.

PWR/OFF/BATT SWITCH

TO PROVIDE MAXIMUM PROTECTION OF NON-VOLATILE MEMORY CONTENTS, ALLOW A MINIMUM OF ONE SECOND BETWEEN SELECTION OF "PWR" AND "OFF" POSITIONS. DO NOT RAPIDLY CYCLE POWER ON AND OFF.

IF THE FM/AM-1200S/A IS PLUGGED INTO A VEHICLE'S DC SUPPLY, DISCONNECT THE SET WHILE STARTING THE ENGINE.

REMOVE ANY POSSIBLE STATIC CHARGE FROM AN UNTERMINATED ANTENNA BEFORE CONNECTING TO THE FM/AM-1200S/A ANT CONNECTOR. THE T/R CONNECTOR MAY BE USED FOR THIS PURPOSE.

DO NOT FORCE RF LEVEL CONTROLS PAST THE STOPS.

Do not apply any signals into the FM/AM-1200S/A other than those defined in the operating instructions. Other than the input power and operating restrictions described above, any combination of front panel control positions will not adversely affect the FM/AM-1200S/A.

2-3 PREPARATION

Preparing the FM/AM-1200S/A for operation is a simple procedure which consists of the following basic steps (Ref. Figures 2-1 and 2-2):

STEP	PROCEDURE
1.	Set FM/AM-1200S/A into a vertical or horizontal operation position, with lid removed.
2.	Apply electrical power to FM/AM-1200S/A as follows:

CAUTION

THE FM/AM-1200S/A IS SHIPPED FROM FACTORY WITH THE AC POWER SELECT SWITCH IN THE 115 VAC POSITION. DO NOT APPLY EXTERNAL POWER ABOVE 115 VAC UNLESS SWITCH IS POSITIONED TO 230 V (REF. FIGURE 2-3) (REF. APPENDIX A, SPECIFICATION A-14).

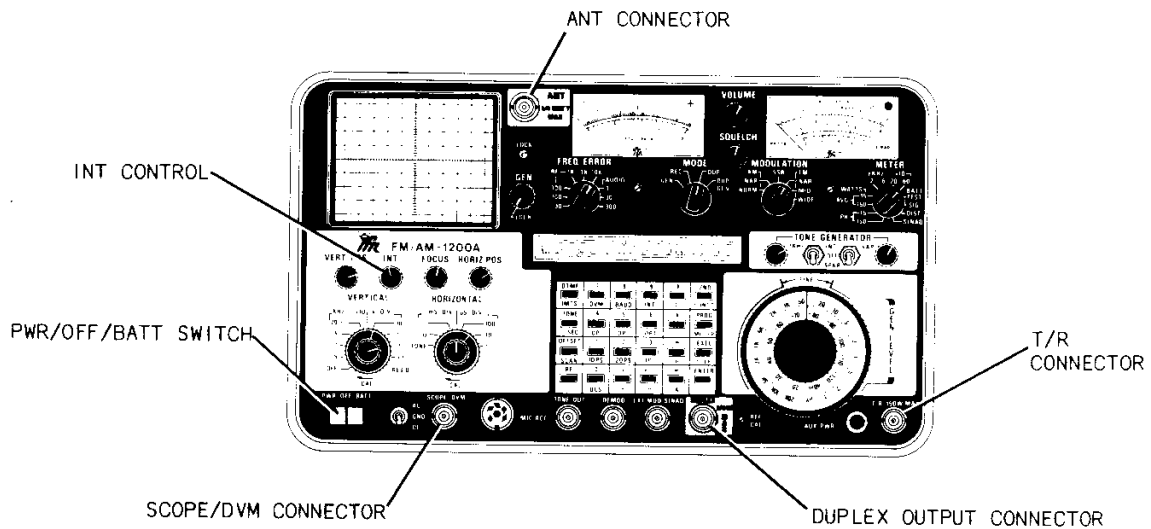

Figure 2-1 FM/AM-1200S/A Front Panel

EXTERNAL AC Power

1. Connect furnished AC power cable between 115/230 VAC power source and AC Power Input Connector on rear panel of FM/AM-1200S/A.
2. Place PWR/OFF/BATT Switch to "PWR" position.

EXTERNAL DC Power

1. Connect supplied DC Power Cable between external 12 to 30 VDC power source and DC Power Input Connector on rear panel of FM/AM-1200S/A.
2. Place PWR/OFF/BATT Switch to "PWR" position.

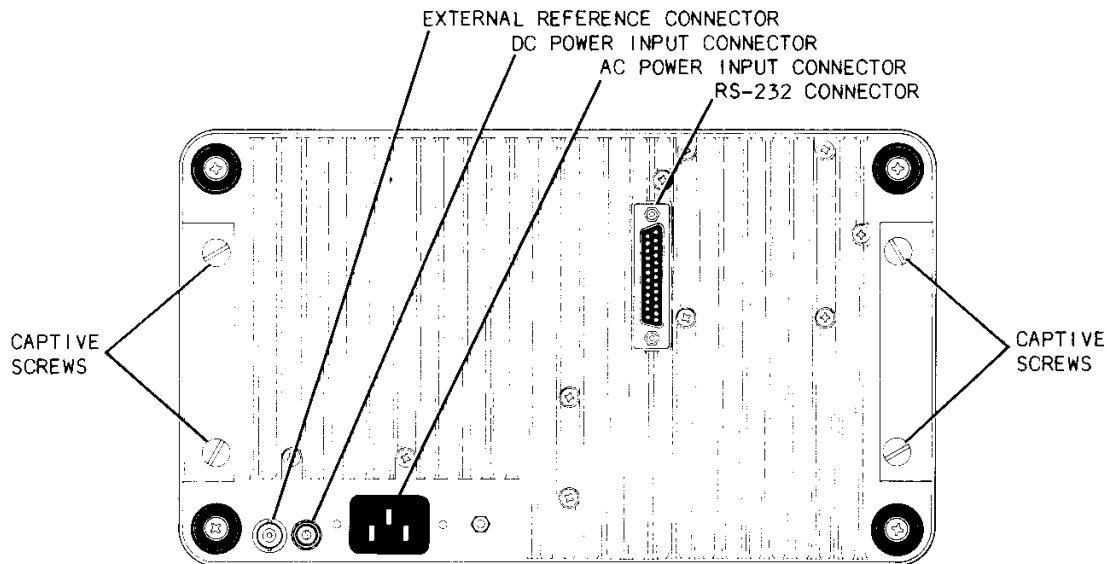

Figure 2-2 FM/AM-1200S/A Rear Panel

INTERNAL Battery Operation:

1. Place PWR/OFF/BATT Switch to "BATT" position. (This is a Spring-Loaded ON/OFF Switch.) When operating the test set on battery, an internal timer will interrupt power after approximately 10 minutes. Depress PWR/OFF/BATT Switch to "BATT" position to restore power to test set.

NOTE

The internal battery is charged whenever the test set is connected to external AC or DC power, regardless of whether the PWR/OFF/BATT Switch is in either the "ON" or "OFF" position. Typical recharge time is 12 hours for a full charge. Minimum external DC input required for full charge is 15 VDC.

NOTE

The oven oscillator (Option 02 only) is powered by the internal battery when the test set is switched to battery operation. In the battery mode, there is no provision for preheating the oven oscillator. A 15-minute warm-up period is required, with the test set at room temperature, in order to stabilize the oven oscillator. However, the FM/AM-1200S/A will turn on and operate immediately in the battery mode, but the oven oscillator frequency will not be within specifications without the required 15-minute warm-up period. It is therefore recommended that the FM/AM-1200S/A be connected to an external AC or DC power source for the required 15-minute warm-up period.

2-4 GENERAL OPERATING DATA

The FM/AM-1200S/A Communications Service Monitor is shipped with the AC Power Select Switch (Ref. Figure 2-3) positioned to "115 VAC". If it is necessary to operate FM/AM-1200S/A using 220 VAC, the AC Power Select Switch must be positioned to "230 VAC" prior to the application of electrical power. The procedure to reposition this switch is as follows:

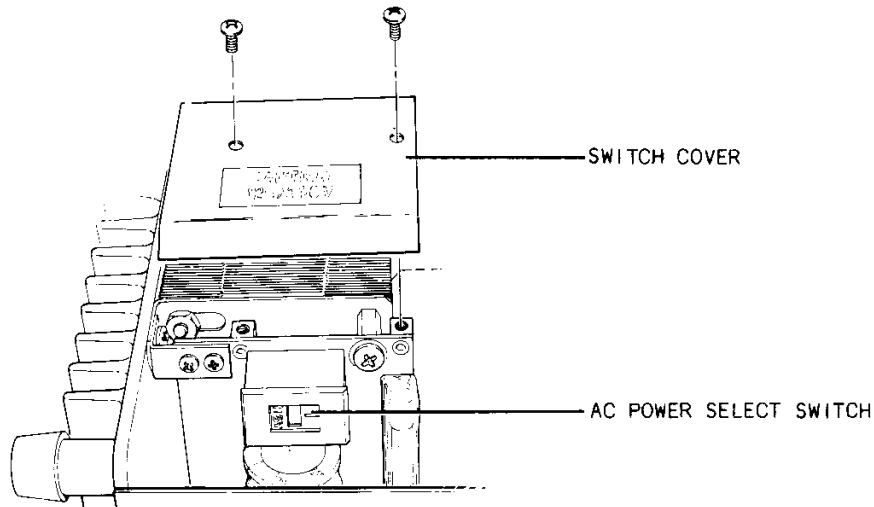

Figure 2-3 AC Power Select Switch Location

CASE REMOVAL

1. Loosen four captive screws attaching rear escutcheon to Rear Panel Heat Sink (Ref. Figure 2-2).
2. Remove escutcheon, then slide case from chassis.

AC POWER SELECT SWITCH POSITIONING

3. Remove two screws from Switch Cover Plate (with CAUTION placard) to expose AC Power Select Switch (Ref. Figure 2-3).
4. Verify position of switch and, if necessary, slide switch indicator until desired power rating is visible (Ref. Figure 2-3).
5. Reinstall Cover Plate (Ref. Figure 2-3).

CASE INSTALLATION

6. Slide case over chassis and engage case in groove of front escutcheon. Position rear escutcheon on case. Engage case in groove of rear escutcheon and tighten four captive screws securing rear escutcheon to Rear Panel Heat Sink.

2-5 EXTERNAL POWER INTERRUPTION PROTECTION

The FM/AM-1200S/A incorporates an external power interruption protection circuit in case the external AC power is unexpectedly lost during FM/AM-1200S/A use. After power is lost, approximately 15 seconds of power will be available to complete or terminate a function.

ITEM NAME DESCRIPTION

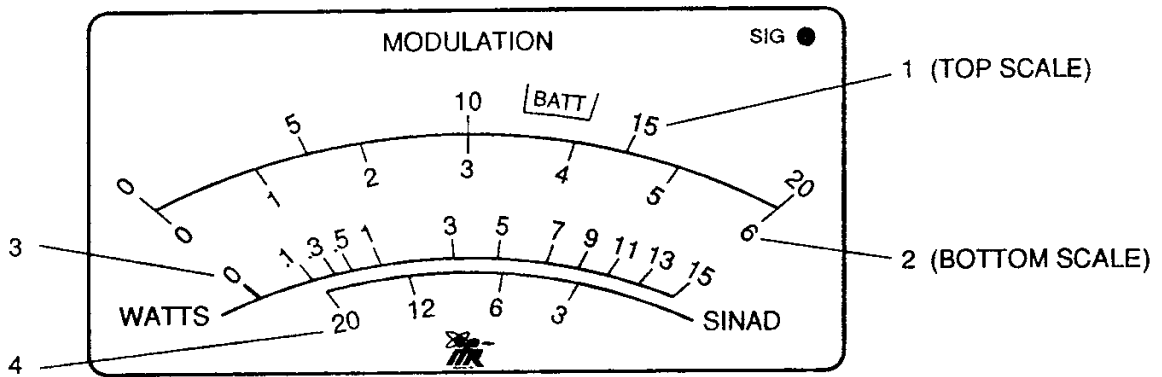

Figure 3-2 MODULATION Meter Scales

MODULATION METER CONTROL POSITION	INPUT SOURCE	MODULATION METER RANGE	MODULATION METER SCALE (Ref. Fig. 3-2)
WATTS AVG 15 150 PK 15 150	T/R CONNECTOR	15 WATTS (full scale) to 150 watts (full scale)	3
kHz/%X10 (All Positions)	FM/AM-1200S/A Demodulator	2 kHz DEV/20% AM (full scale) to 60 kHz DEV/600% AM (full scale)	1 & 2
BATT TEST	Internal Battery	0 to 20 VDC	1
SIG	ANTenna Connector	Relative signal strength (not calibrated)	None; observe relative deflection of meter needle
DIST	EXT MOD/SINAD Connector	0% to 20%	1
SINAD	EXT MOD/SINAD Connector	3 dB to 20 dB	4

Table 3-2 Modulation Meter Control Positions

NOTE

For Accurate Power Meter measurements, set RF Level Attenuator Control (9) to any position other than -20 dBm.

ITEM	NAME	DESCRIPTION
5.	<u>VAR Tone Selector Switch</u>	Selects variable tone as follows: "INTL" - Internal modulation of generator output, and TONE OUT Connector (17). TONE OUT Connector (17) and HORIZONTAL Sweep Selector Control (26) in TONE Position. "OFF" - Disconnects tone from internal modulation, TONE OUT Connector (17), HORIZONTAL Sweep Selector Control (26) and Speaker. "SPKR" - Variable tone will be routed to the FM/AM-1200S/A Speaker only.
6.	<u>VAR Tone Level Control</u>	Controls variable tone level.
7.	<u>1 kHz Selector Switch</u>	Selects 1 kHz fixed tone as follows: "INTL" - Internal modulation of generator output and TONE OUT Connector (17). TONE OUT Connector (17) and HORIZONTAL Sweep Selector Control (26) in TONE Position. "OFF" - Disconnects tone from internal modulation, TONE OUT Connector (17), HORIZONTAL Sweep Selector Control (26) and Speaker. "SPKR" - 1 kHz fixed tone will be routed to FM/AM-1200S/A Speaker only.
8.	<u>1 kHz Tone Level Control</u>	Controls 1 kHz fixed tone level.
9.	<u>RF Level Attenuator Control</u>	Controls RF output level of the FM/AM-1200S/A signal generator in 10 dB steps.
10.	<u>RF Level Attenuator Vernier Control</u>	Provides fine adjustment of RF Output Level of FM/AM-1200S/A Signal Generator, as indicated on dBm/ μ v scale.
11.	<u>T/R Connector</u>	Generator/Receive Connector.

CAUTION

DO NOT APPLY MORE THAN 150 WATTS TO THIS CONNECTOR. IRREVERSIBLE DAMAGE TO INTERNAL COMPONENTS OF FM/AM-1200S/A MAY RESULT.

ITEM	NAME	DESCRIPTION
12.	<u>AUX POWER Connector</u>	+12 V is applied to this connector in Generate and Duplex Generate modes (for the Option 05, Generator Amplifier Only).
13.	<u>REF CAL Adjustment</u>	For adjustment of FM/AM-1200S/A Master Oscillator (TCXO).
14.	<u>DUPLEX Output Connector</u>	In Duplex mode, a fixed -60 dB (± 10 dB) is present at the DUPLEX Output Connector (FM/AM-1200A Only) at the selected offset frequency. For the FM/AM-1200S, the output is -15 dBm (± 10) when in DUPLEX HIGH mode and -25 dBm (± 5 dB) below the DUPLEX HIGH output when in the DUPLEX LOW mode. In the Tracking Mode (FM/AM-1200S only with Option 12 installed), the output is -5 dBm ($+3/-5$ dB) in TRACK HIGH mode, -15 dBm (± 7 dB) in TRACK MED mode and -40 dBm ($+5/-10$ dB) when in the TRACK LOW mode.
15.	<u>EXT MOD/SINAD Connector</u>	Allows application of external modulation when "Generate" Mode is selected. Permits measurement of UUT SINAD and/or Distortion when Modulation METER Control (4) is positioned to "SINAD" or "DIST".
16.	<u>DEMODO Connector</u>	Allows external scope monitoring of the demodulated received or generated audio signal.
17.	<u>TONE OUT Connector</u>	When either VAR Tone Selector Switch (5) or 1 kHz Tone Selector Switch (7) are positioned to "INTL"; variable, fixed or both tones are present at this connector.
18.	<u>Keyboard</u>	Used for data entry and control of FM/AM-1200S/A microprocessor as described in paragraph 3-3.
19.	<u>MIC/ACC Connector</u>	Allows use of external microphone (Ref. appropriate Pin-Out Table in Appendix B).

NOTE

With microphone connected, depressing MIC Key will automatically switch FM/AM-1200S/A internally to generate mode if the Mode Selector Control (39) is in receive or duplex positions.

ITEM	NAME	DESCRIPTION
------	------	-------------

20. SCOPE/DVM Connector
Oscilloscope or DVM external input.

CAUTION

DO NOT APPLY MORE THAN 100 VDC, 100 VRMS OR A COMBINATION OF 50 VDC AND 50 VRMS TO THIS CONNECTOR.

21. AC/GND/DC Switch
Allows selection of AC or DC coupling of oscilloscope external input.

22. PWR/OFF/BATT Switch
Applies/interrupts power to FM/AM-1200S/A as follows:

"PWR" position - FM/AM-1200S/A is powered by external AC or DC power source.

"OFF" position - FM/AM-1200S/A is "OFF".

"BATT" position - FM/AM-1200S/A is powered by internal battery (This is a momentary spring-loaded switch to the "OFF" position).

NOTE

Internal FM/AM-1200S/A battery is continuously charged when external AC power or external DC power, ABOVE 15 VDC, is connected to set, regardless of PWR/OFF/BATT Switch (22) position.

23. Scope VERTICAL Attenuator Vernier Control
Divides vertical attenuator rate by a factor of from 1 to 10. In the "CAL" position (fully cw), the factor is 1 and the attenuator rate is as selected by the VERTICAL Attenuator Selector Control (24). In the fully ccw position, the factor is 10. In any intermediate position, the factor is between 1 and 10.

24. VERTICAL Attenuator Selector Control
Turns power "OFF" to Scope Display.

kHz/%x10 - Allows selection of internal demod audio signal.

V/Div - Allows selection of Scope/DVM Connector (20) inputs.

RESID - Displays residual distortion when MODULATION Meter Control (4) is positioned to "SINAD" or "DIST".

ITEM	NAME	DESCRIPTION
------	------	-------------

25. HORIZONTAL Sweep Vernier Control
 Divides horizontal sweep rate by a factor of from 1 to 10. In the "CAL" position (fully cw), the factor is 1 and the sweep rate is as selected by the HORIZONTAL Sweep Selector Control (26). In the fully ccw position, the factor is 10. In any intermediate position, the factor is between 1 and 10.

26. HORIZONTAL Sweep Selector Control

FM/AM-1200A Only - Selects horizontal sweep rate of the oscilloscope. This control functions as follows:

TONE position - Oscilloscope horizontal sweep is driven by waveform output of tone generators.

mS/DIV positions - Represent oscilloscope sweep rate in milliseconds per division, when Scope Horizontal Sweep Vernier Control (25) is in CAL position (fully clockwise).

S/DIV positions - Represent oscilloscope sweep rate in microseconds per division, when Scope HORIZONTAL Sweep Vernier Control (25), is in the CAL position (fully cw).

FM/AM-1200S Only - Selects horizontal sweep rate of the oscilloscope or dispersion of Spectrum Analyzer. Dispersion Control functions as follows:

TONE position - Oscilloscope horizontal sweep is driven by waveform output of tone generators.

mS/DIV positions - Represent oscilloscope sweep rate in milliseconds per division, when Scope Horizontal Sweep Vernier Control (25) is in CAL position (fully clockwise).

NOTE

The Spectrum Analyzer operates in the following positions:

MHz/DIV positions
 kHz/DIV positions

ITEM NAME DESCRIPTION

HORIZONTAL/DISPERSION	BANDWIDTH
1 kHz/DIV	300 Hz
2 kHz/DIV	300 Hz
5 kHz/DIV	3 kHz
10 kHz/DIV	3 kHz
20 kHz/DIV	3 kHz
50 kHz/DIV	30 kHz
.1 MHz/DIV	30 kHz
.2 MHz/DIV	30 kHz
.5 MHz/DIV	30 kHz
1 MHz/DIV	30 kHz

Table 3-3 Horizontal Sweep Selector Control
(Analyzer Dispersion Control) Settings

27. VERT POS Control

Controls vertical position of CRT trace in Oscilloscope and Spectrum Analyzer (FM/AM-1200S only) functions. Spectrum Analyzer function is attenuated and limits this control to nominal division up or down.

28. INT Control

Controls intensity of CRT trace. Clockwise rotation of control increases trace intensity.

CAUTION

DO NOT OPERATE CRT DISPLAY (31) WITH EXCESSIVE TRACE INTENSITY. PROGRESSIVE DAMAGE TO CRT MAY RESULT.

29. FOCUS Control

Controls focus of CRT trace.

30. HORIZ POS Control

Controls horizontal position of CRT trace in Oscilloscope and Spectrum Analyzer (FM/AM-1200S only) functions. Spectrum Analyzer function is attenuated and limits this control to nominal 1 division left or right.

31. CRT Display

Display screen for Oscilloscope and Spectrum Analyzer (FM/AM-1200S only) functions.

32. GEN/LOCK Control

Allows the RF frequency to be slewed off frequency in Generate and Duplex Generate. Acts as a clarifier when receiving SSB.

ITEM	NAME	DESCRIPTION
------	------	-------------

33. LOCK Lamp
Indicates in the following manner:
- Steady Light - RF frequencies are phase locked.
- Blinking Light - GEN/LOCK Control (32) is out of the "LOCK" position or FM/AM-1200S/A is experiencing a malfunction.

34. ANT Connector
External Antenna Input.

CAUTION

TO PREVENT DAMAGE TO FM/AM-1200S/A INTERNAL COMPONENTS, MAXIMUM CONTINUOUS INPUT TO ANTENNA CONNECTOR (34) MUST NOT EXCEED 0.25 WATT.

35. FREQ ERROR Meter Range Selector Control
Selects full scale sensitivity of FREQ ERROR Meter (36) between RF and audio frequency ranges. The audio frequency error is referenced to the Variable Tone Generator.

36. FREQ ERROR Meter
Provides a visual display of the difference between received signal frequency and selected FM/AM-1200S/A receiver frequency.
- Provides a visual display of the difference between the DEMOD audio signal frequency and selected variable tone generator.

37. VFD (Vacuum Fluorescent Display)
Provides display of selected Keyboard entries as described in paragraph 3-3.

38. FREQ ERROR Meter Zero Adjustment
Mechanical zero adjustment for FREQ ERROR Meter (36), when power to FM/AM-1200A is "OFF".

39. MODE Selector Control

GEN Position - Places FM/AM-1200S/A in the generate mode. Transmitting into the T/R Connector (11), will automatically change FM/AM-1200S/A "Receive".

REC Position - Places FM/AM-1200S/A in the receive mode to receive through the ANT Connector (34).

DUP Position - Turns on FM/AM-1200S/A Duplex Generator, allowing signal output at DUPLEX Output Connector (14) and T/R Connector (11). However, the FM/AM-1200S/A will remain in the "receive" mode.

ITEM	NAME	DESCRIPTION
------	------	-------------

NOTE

Full receive capability exists, even when transmitting into T/R Connector (11).

DUP GEN Position - Places FM/AM-1200S/A into generate mode with the Generator on and offset by a pre-programmed amount.

NOTE

In this position, automatic receive mode is overridden when transmitting into T/R Connector (11) with external transmitter. The DUP GEN Output is only available at the T/R Connector (11) with the level controlled by the RF Level Attenuator Control (9).

- 40. VOLUME Control
Controls volume of FM/AM-1200S/A speaker.
- 41. SQUELCH Control
Controls receiver squelch threshold. Squelch disables audio output, freq error and modulation indicators when RF input at ANT Connector (34) falls below squelch threshold.
- 42. SIG Indicator Lamp
When illuminated, indicates input level at ANT Connector (34) is above squelch threshold of FM/AM-1200S/A receiver.

3-2 FM/AM-1200S/A REAR PANEL

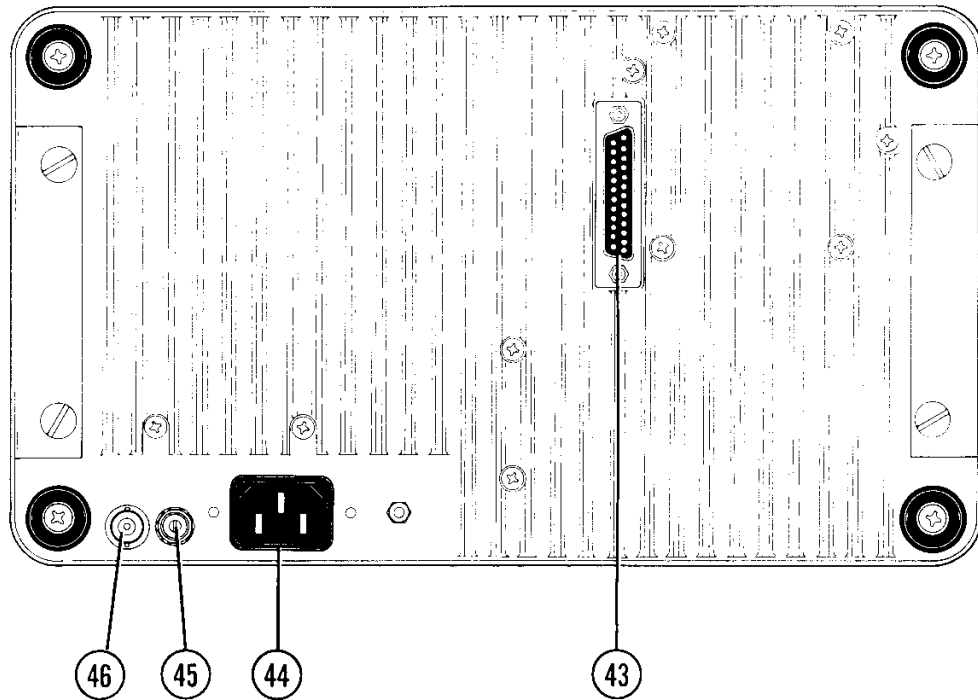

Figure 3-3 FM/AM-1200S/A Rear Panel Connectors

- | | |
|---------------------------------------|----------------------------------|
| 43. RS-232/GPIB (Option 13) Connector | 45. DC Power Input Connector |
| 44. AC Power Input Connector | 46. External Reference Connector |

ITEM	NAME	DESCRIPTION
43.	<u>RS-232/GPIB (Option 13) Connector</u>	Female connector for interface with external RS-232 compatible keyboard (Ref. appropriate Pin-Out Table in Appendix B).
44.	<u>AC Power Input Connector</u>	AC power input connector for 105-130/210-260 VAC supply at 50 to 400 Hz.
45.	<u>DC Power Input Connector</u>	DC power connector for 12 to 30 VDC supply.
46.	<u>External Reference Connector</u>	Allows monitoring of 10 MHz internal reference frequency or the application of an external 10 MHz reference frequency. The input and output are automatically switched.

NOTE

Automatic switching to external source occurs when an external 10 MHz reference frequency of +5 dB, or greater, is applied at External Reference Connector. DO NOT EXCEED 1/2 WATT INPUT.

3-3 KEYBOARD AND VFD DESCRIPTION

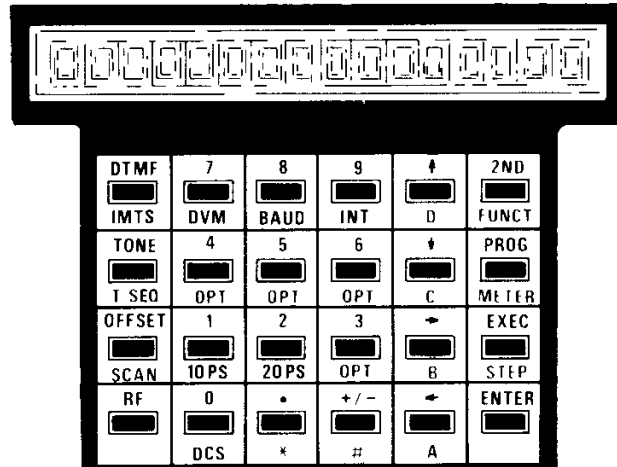

Figure 3-4 Keyboard and VFD Layout

The FM/AM-1200S/A Keyboard and VFD (Vacuum Fluorescent Display) provides a means of entering data into the microprocessor to control the various operating parameters of the RF frequency, tone generator and duplex generator offset frequency. Normal Keyboard operation involves the following three basic types of key entry sequences:

- A. "DIRECT" MODE
Key entries allow simultaneous programming and execution.
- B. PROGRAM MODE
PROG Key entries allow retrieval, edit and storage without the execution.
- C. EXECUTE MODE
EXEC Key entries allow retrieval and automatic execution without edit capability.

The primary objective of this subsection is to familiarize the operator with the methods of making keyboard entries. A complete description of the Keyboard and VFD operation is located in Section 4.

The FM/AM-1200S/A Keyboard consists of 24 keys which provide a means of entering data into the microprocessor to control the frequency of the signal generator, receiver, duplex generator offset and tone generator functions.

3-3-1 FUNCTION KEYS

These keys determine what FM/AM-1200S/A function is selected by the operator. Most keys have a dual function which will select either the 1st order functions (DTMF, TONE, OFFSET and RF) or 2nd order functions (IMTS, T SEQ, SCAN, DVM, DCS, BAUD, INT, STEP, METER, 10PS, 20PS and a selection of 4 additional options).

1st ORDER FUNCTIONS (Black Lettering on Keyboard)

These functions are used to set the operating parameters of:

- Dual Tone Multiple Frequency (DTMF)
- Variable Tone Generator (TONE)
- Duplex Offset Generator Frequency (OFFSET)
- Signal Generator or Receiver Frequencies (RF)

2nd ORDER FUNCTIONS (Blue Lettering on Keyboard)

All second order function keys must be preceded by the "2ND FUNCT" Key.

- FREQ ERROR and Modulation Meter Indications (METER)
- Mobile Pulse Dialing/IMTS (IMTS)
- Tone ON/OFF Duration Selection (TSEQ)
- RF Program Function (SCAN)
- Digitally Coded Squelch (DCS)
- Step Function (STEP)
- VFD Intensity (INT)
- Digital Voltmeter (DVM)
- Variable Pulsed Audio @ 10 PPS (10 PS)
- Variable Pulsed Audio @ 20 PPS (20 PS)
- BAUD Rate Set (BAUD)
- FM/AM-1200S/A Future Expansion (OPT)

NOTE

For a detailed explanation of the Variable Pulsed Audio Feature, based on the 2805/1500 type signalling system, refer to paragraph 4-4-9.

3-3-2 INSTRUCTION KEYS

These keys instruct the FM/AM-1200S/A processor to perform a specific operation or function to permit the execution of a key entry. Specific key functions are as follows:

2ND FUNCT Key - Conditions the FM/AM-1200S/A processor for a 2nd order function entry; this key must precede the 2nd function entry. When this key is depressed, the VFD will display "2ND FUNCTION".

PROG Key - Allows entry into the programming parameters of the FM/AM-1200S/A. All Keyboard entries are immediately displayed on the VFD but will not be executed by the processor.

EXEC Key - Retrieves stored data and automatically executes the data.

ENTER Key - Instructs processor that the preceding key-in sequence has been completed (i.e., RF Freq's, DTMF Sequences, etc.). Depress ENTER Key twice to exit from execute mode and return to the direct mode.

3-3-3 CURSOR CONTROL KEYS

The ← and → Keys will move the cursor laterally within the VFD viewing area for purposes of changing data values. To change a data value, the cursor must be positioned directly on the desired character position prior to making a value change. The ↑ and ↓ Keys are used to increment (↑) or decrement (↓) any value positioned in the cursor and any adjacent values which are affected by "carry" and "borrow" operations. In addition, the ↑ or ↓ keys are used to slew through the stored memory fields.

3-3-4 DATA ENTRY KEYS

These keys include standard numerical value keys from 0 through 9, as well as eight special symbol keys which are used to enter:

- A. Decimal point (Justifies Tone, Offset and RF Fields)
- B. A change of sign (+/-) (Used with Offset, DCS and DVM functions only)
- C. A, B, C, D, # and * (telephone associated symbols), used in conjunction with the DTMF or IMTS functions.

NOTE

A, B, C, D, # and * are also used for program preset position selections 10 through 15. These data entry keys must be preceded by the 2nd Function Key.

SECTION 4 - OPERATION

4-1 GENERAL

On power-up, the FM/AM-1200S/A initiates a memory check. If no error is indicated on VFD (37), the last RF Frequency is executed and displayed on VFD (37), indicating the test set is ready for direct operation.

The FM/AM-1200S/A has three modes of operation which are explained in the following paragraphs. The three modes of operation are:

- A. Direct Data Entry
- B. Programmed Data Entry into memory
- C. Executed Data Entry from memory

4-1-1 Mini-Index of Contents Within This Section. (Refer to Table of Contents in Front of Manual for a Complete Listing).

Paragraph	Title	Page
KEYBOARD AND VFD OPERATION		
4-2	Direct Data Entry.....	4-2
4-3	Programmed Data Entry Into Memory.....	4-8
4-4	Executed Data Entry.....	4-21
BASIC OPERATING PROCEDURES		
4-5	Receiver Operation.....	4-28
4-6	RF Signal Generator Operation (Simplex).....	4-34
4-7	Duplex Operation.....	4-40
4-8	Oscilloscope Operation.....	4-44
4-9	Spectrum Analyzer Operation.....	4-47
4-10	Tone Generator Operation.....	4-49
RS-232 OPERATION		
4-11	Basic RS-232 Operation.....	4-50

4-2 DIRECT DATA ENTRY

The following steps describe the methods of making direct keyboard entries to control the FM/AM-1200S/A RF Frequency, Offset Generator Frequency and Tone Generator Functions. Once a particular function key is depressed, the FM/AM-1200S/A assumes a programming/edit and execution mode of operation. In this mode, the FM/AM-1200S/A will execute each key entry, as it is selected, while allowing the operator the capability to edit programmed data indicated on the VFD (37).

CAUTION

ANY CHANGES IN DATA WHEN OPERATING IN THE DIRECT MODE WILL CAUSE CHANGES TO THE PRE-PROGRAMMED MEMORY SETTINGS.

4-2-1 Direct RF Data Entry

KEY ENTRY

VFD (37) INDICATES



FLASHING LOCATION IS CURSOR POSITION

Directly enter the desired RF Frequency using the keyboard digits.

EXAMPLE: Enter RF Frequency of 123.4567 MHz.

KEY ENTRY

VFD (37) INDICATES

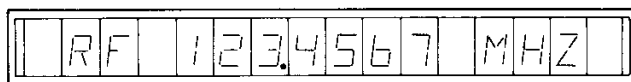
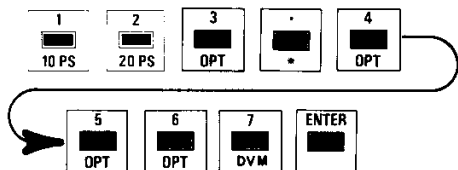

4-2-2 Direct Tone Entry

KEY ENTRY

ACTION

DEPRESS TONE Key Selected function appears on left side of VFD (37) and VFD cursor is positioned on first character.

NOTE

To monitor tone, select "SPKR" with VAR Tone Selector Switch (5) and adjust VAR Tone Level Control (6) to a comfortable listening level. If no key is depressed after approximately 6 seconds, selection will default to the RF function.

Operator's Choice: Selected number character will be displayed, in progression, on VFD (37).

NOTE

While each number key is depressed, its assigned tone will be generated and the selected characters will appear, in order of selection, on VFD (37). To terminate a completed entry, depress the "ENTER" Key.

EXAMPLE: Direct TONE Entry

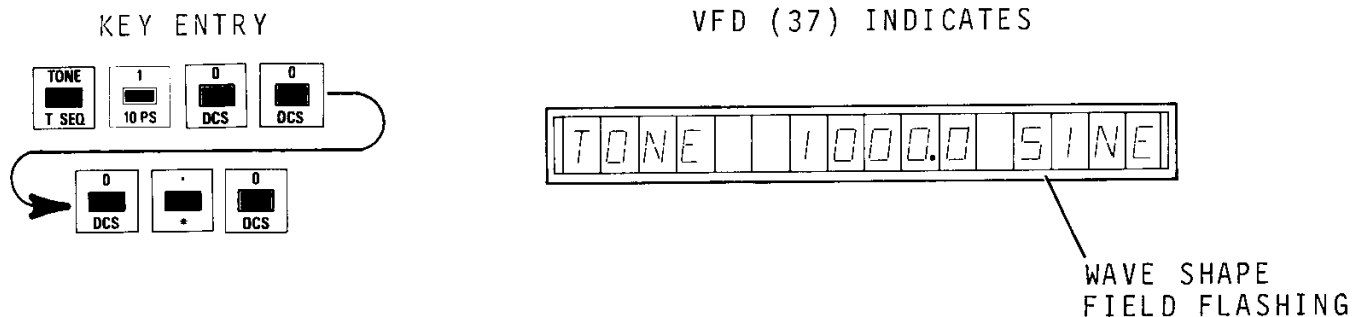

EXAMPLE: Wave Shape Selection

To change wave shape, use → Key to move cursor to the right until wave-form title flashes. Use the ↑ or ↓ Keys to change wave shape.

(See example on following page for sample wave shapes.)

Alternate Method For
Changing Wave Shape:

ENTER 0 for Sine Wave
1 for Square Wave
2 for Ramp Wave
3 for Triangle
Wave

SINE

SINE WAVE

SQU

SQUARE WAVE

RAMP

RAMP WAVE

TRI

TRIANGLE WAVE

Depress  Key.

NOTE

DTMF may be used simultaneously with the variable tone generator for audio tone encoding.

4-2-3 Direct DTMF and IMTS Entries

KEY ENTRY

ACTION

DTMF or IMTS

Selected function appears on left side of VFD (37) and VFD cursor is positioned on first character.

NOTE

If no key is depressed after approximately 6 seconds, selection will default to RF function.

The DTMF tone is set at a fixed level to modulate the generator at approximately 3.5 kHz.

Operator's Choice:
0 thru 9, A thru
D, # and/or *

Selected character (number, letter or symbol) will be displayed, in progression, on VFD (37).

EXAMPLE: Display DTMF 0123456789ABCD#*

KEY ENTRY

VFD (37) INDICATES

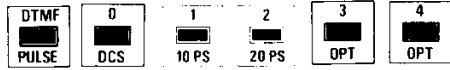

Displaying Five Digit Number



Displaying Ten Digit Number

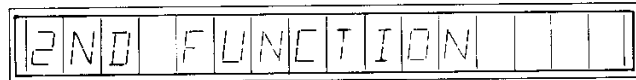

Displaying Eleven Digit Number

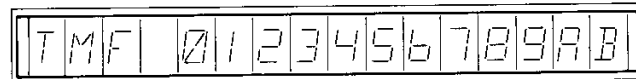
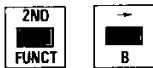

Displaying Twelve Digit Number

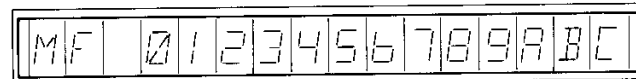
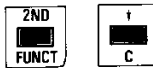

Displaying Thirteen Digit Number

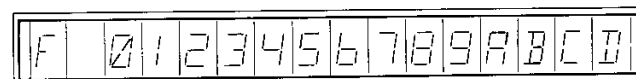

Displaying Fourteen Digit Number

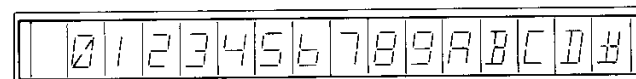
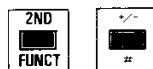

Displaying Fifteen Digit Number

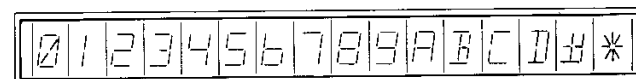
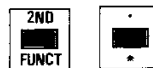

Displaying Sixteen Digit Number

EXAMPLE: Display IMTS (PULSE) 01234567890ABCD#*.

KEY ENTRY

VFD (37) INDICATES

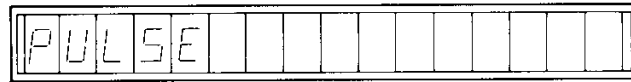

Proceed with sequence as in DTMF example.

Depress  Key.

NOTE

Initial pulse tone is the standard IMTS capture tone.

4-2-4 Direct OFFSET Entry

The OFFSET key is used to set the DUPLEX OFFSET Frequency. The duplex generator frequency is the receiver frequency plus the offset frequency.

KEY ENTRY

ACTION

OFFSET

OFFSET appears on left side of VFD (37) and VFD cursor is positioned on first character.

Operator's Choice:
0 thru 9, +/-

Selected character (number) will be displayed on VFD (37).

EXAMPLE: Enter DUPLEX OFFSET of +1.23 MHz.

KEY ENTRY

VFD (37) INDICATES

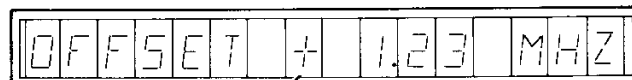

key is used to change sign.

Depress  Key.

4-2-5 Meter Function

VFD (37) will digitally indicate FREQ ERROR Meter (37) and MODULATION Meter (1) readings, as selected by FREQ ERROR Meter Range Selector Control (35) and Modulation METER Control (4).

KEY ENTRY

VFD (37) INDICATES

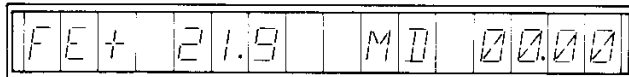
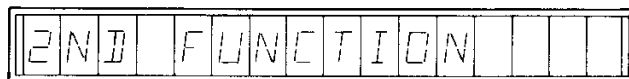

WATTS AVERAGE =

SINAD =

DISTORTION =

SIGNAL =

BATTERY TEST =

WATTS PEAK =

MODULATION =

4-2-6 Set Intensity (VFD)

1st Order Numbers 0 thru 9 will change VFD intensity to a preset level corresponding to number depressed (0 = minimum and 9 = maximum). ↑ or ↓ Keys will slew intensity from minimum to maximum in approximately 4 seconds.

KEY ENTRY

VFD (37) INDICATES

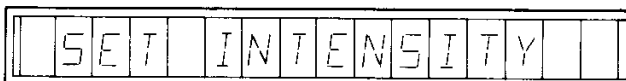

4-3 PROGRAMMED DATA ENTRY INTO MEMORY

The "PROG" Key is used to program up to sixteen different memory locations in the FM/AM-1200S/A. The following functions can be programmed:

RF	DTMF/IMTS
TONE	OFFSET

The following functions can only be programmed for one preset input:

T SEQ	STEP (RF)
SCAN	STEP (TONE)
DCS	

4-3-1 Programmed RF Memory

KEY ENTRY

VFD (37) INDICATES

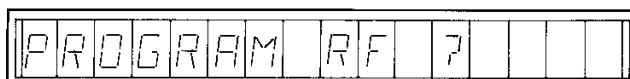
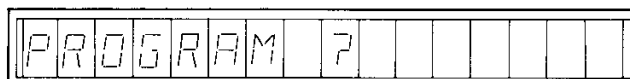

Program any one of the memory locations by selecting the number, letter, or symbol corresponding to that memory location as shown in Table 4-1.

Key	Memory Location
Ø	= Ø
1	= 1
2	= 2
3	= 3
4	= 4
5	= 5
6	= 6
7	= 7
8	= 8
9	= 9

Key	Memory Location
2nd/A	= 1Ø
2nd/B	= 11
2nd/C	= 12
2nd/D	= 13
2nd/#	= 14
2nd/*	= 15

Table 4-1 Program Memory Locations

KEY ENTRY

VFD (37) INDICATES

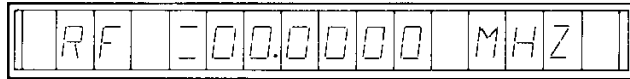

Enter desired frequency into memory.

NOTE

Leave memory location "0" for the direct mode operation because it will change the stored memory data.

EXAMPLE: Program Memory Location "10".

KEY ENTRY

VFD (37) INDICATES

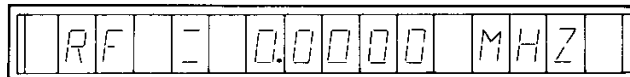
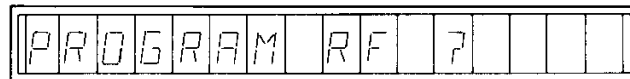

Enter desired frequency into memory.

Depress  Key.

4-3-2 Programmed Tone Memory

KEY ENTRY

VFD (37) INDICATES

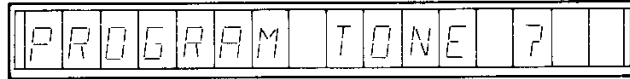
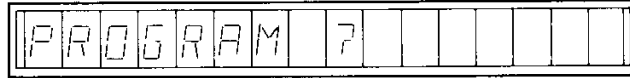

Program any one of the memory locations by selecting the number, letter or symbol corresponding to that memory location as shown in Table 4-1.

KEY ENTRY

VFD (37) INDICATES

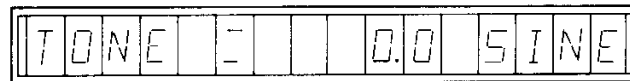

Enter desired 6-digit frequency into memory.

NOTE

After last digit of tone frequency is entered, cursor will flash over waveform.

Enter desired waveform.

KEY ENTRY

VFD (37) INDICATES



TONE 000000.0 SINE



TONE 000000.0 SQU



TONE 000000.0 RAMP



TONE 000000.0 TRI

NOTE

↑ and ↓ cursor can be used to scroll through waveforms.

EXAMPLE: Program Memory Location "15".

KEY ENTRY

VFD (37) INDICATES



PROGRAM ?



PROGRAM TONE ?



2ND FUNCTION



TONE 000000.0 SINE

Enter desired frequency and waveform.

Depress  Key.

NOTE

Leave memory location "0" for the direct mode operation because it will change the stored memory data.

4-3-3 Programmed DTMF and IMTS Memory

DTMF and IMTS (PULSE) functions use the SAME memory location.

KEY ENTRY

VFD (37) INDICATES

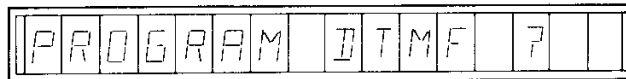
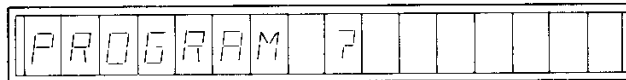

Program any one of the memory locations by selecting the number, letter or symbol corresponding to that memory location as shown in Table 4-1.

KEY ENTRY

VFD (37) INDICATES

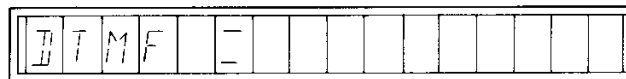

Enter the desired telephone number (16 digits available) into memory.

EXAMPLE: Program Telephone Number 1-316-522-4981 into Memory Location "3".

KEY ENTRY

VFD (37) INDICATES

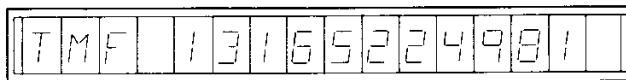
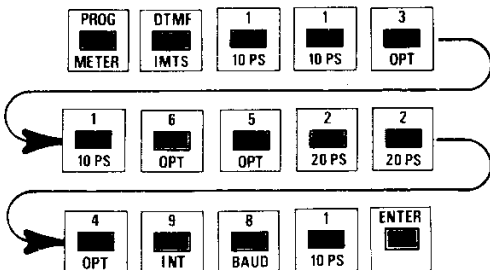

EXAMPLE: Program memory location "12".

KEY ENTRY

VFD (37) INDICATES

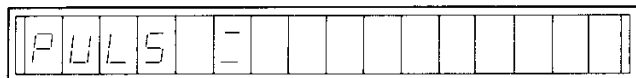
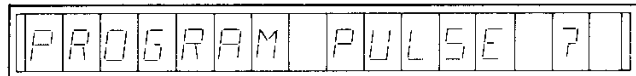
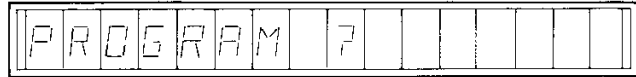

Enter desired IMTS telephone number.

Depress  Key.

NOTE

The digit under the cursor and all digits to the right of the cursor will be blanked upon depressing the  Key.

Leave memory location "0" for the direct mode operation because it will change the stored memory data.

4-3-4 Programmed OFFSET Memory

KEY ENTRY

VFD (37) INDICATES

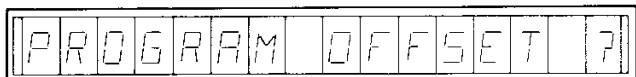

Program any one of the memory locations by selecting the number, letter or symbol corresponding to that memory location as shown in Table 4-1.

KEY ENTRY

VFD (37) INDICATES

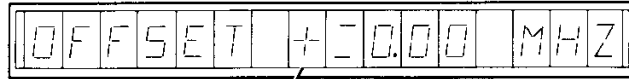

KEY IS USED TO CHANGE SIGN

Enter desired offset frequency into memory. Depress  Key.

NOTE

Maximum frequency is ± 49.99 . Any frequency above ± 49.99 will default to ± 49.99 although the entered frequency will be displayed on VFD (37).

NOTE

Leave memory location 0 for the direct mode operation because it will change the stored memory data.

4-3-5 Programmed DCS Memory

KEY ENTRY

VFD (37) INDICATES

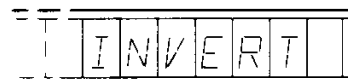
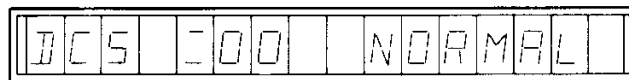
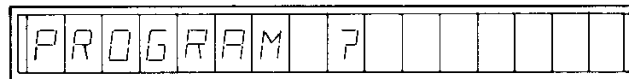

NOTE

 Key will change polarity between INVERT and NORMAL.

Enter desired DCS Code and Polarity into memory.

Depress  Key.

4-3-6 Programmed T SEQ Memory

T SEQ programs the ON time and OFF time of each of the 16 tone memory locations. All 16 (0 thru 15) locations must be programmed as all tone locations will be executed in sequential order. Any tone memory locations which are not to be executed by the T SEQ function must be given no "ON TIME" and no "OFF TIME".

KEY ENTRY

VFD (37) INDICATES

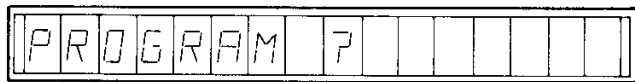

TONE MEMORY LOCATION NUMBER

ON TIME

OFF (DEAD) TIME

Use  Key to set tone memory location number to zero.

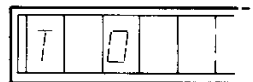

NOTE

↑ and ↓ Key in the T SEQ Mode are used to scroll through the tone memory location numbers only.

KEY ENTRY

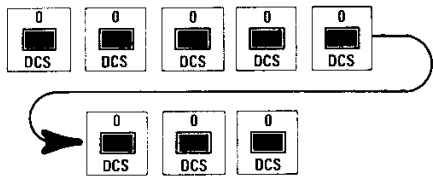

VFD (37) INDICATES

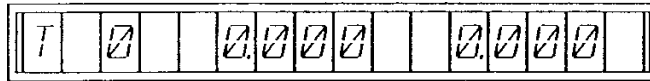

Tone memory location is now programmed for no "ON TIME" and no "OFF (DEAD) TIME" causing the FM/AM-1200S/A to ignore the tone stored in memory location "0" from the tone sequence.

KEY ENTRY

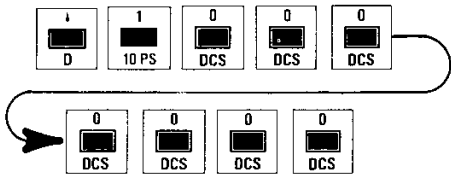

VFD (37) INDICATES

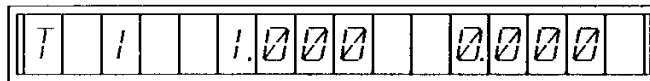

The above key entry sequence programmed tone "1" memory location for an "ON TIME" of 1.0 Sec. and for no dead time between execution of the next tone.

KEY ENTRY

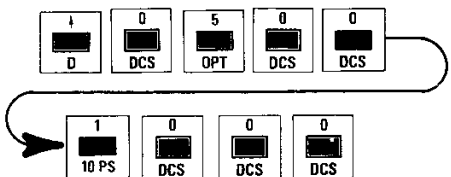

VFD (37) INDICATES

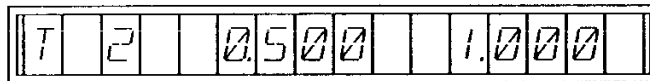

The above key entry sequence programmed tone "2" memory location for an "ON TIME" of 0.5 Sec. and an "OFF TIME" of 1.0 Sec before execution of next tone. The remainder of the tone locations (3 through 15) may be set to no "ON TIME" and no "OFF TIME". If so, when T SEQ function is executed (see paragraph 4-4-7), the tone entered into tone memory locations 1 and 2 will be executed and the rest ignored.

4-3-7 Programmed Two Tone Sequence Memory

Two tone sequence, programs the "ON TIME" for tone memory locations "1" and "2". Both memory locations for two tone sequence must be programmed with "ON TIME" only; all other tone memory locations (0 and 3 thru 15) must have the "ON TIME" zeroed out for two tone sequence to operate properly.

Example

Program a two-tone sequence of an 800 Hz tone of 1 second duration into memory location "1" and a 600 Hz tone of 3 seconds duration into memory location "2" by following these steps:

STEP _____ VFD (37) INDICATES _____

1. Enter the tone 1 frequency.

Press

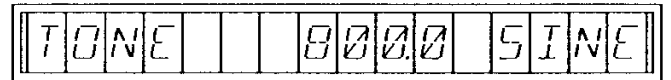
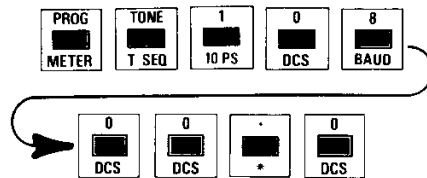

and ↑ until VFD displays:

2. Enter the tone 2 frequency.

Press

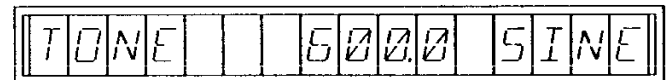
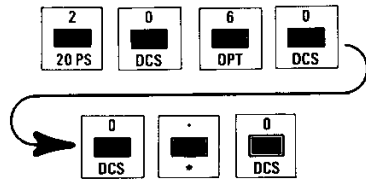

3. Enter the "ON TIME" for tone 2.

Press

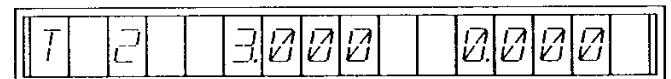
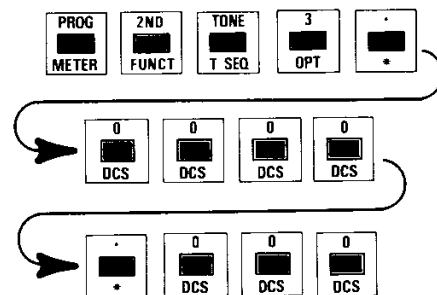

4. Enter the "ON TIME" for tone 1.

Press

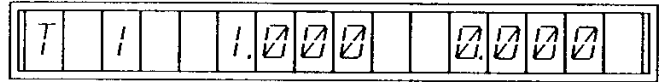
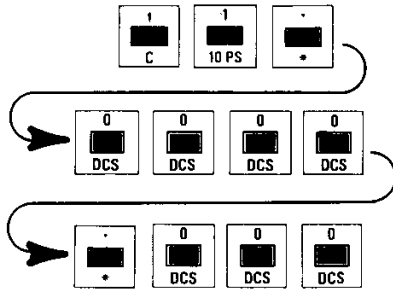

5. Zero out the "ON TIME" for memory location "0".

Press

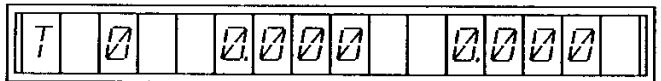
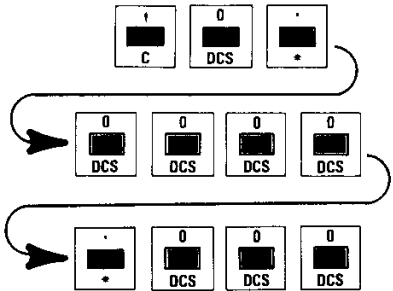

6. Use the ↑ to go to memory location 3 through 15 and set each "ON TIME" to zero.

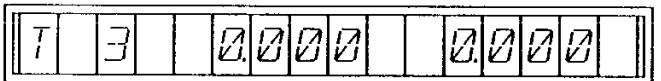

through

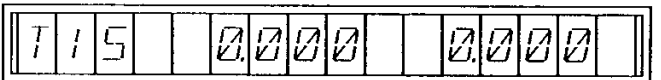

7. To execute two tone sequence,

press

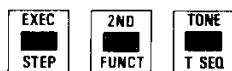

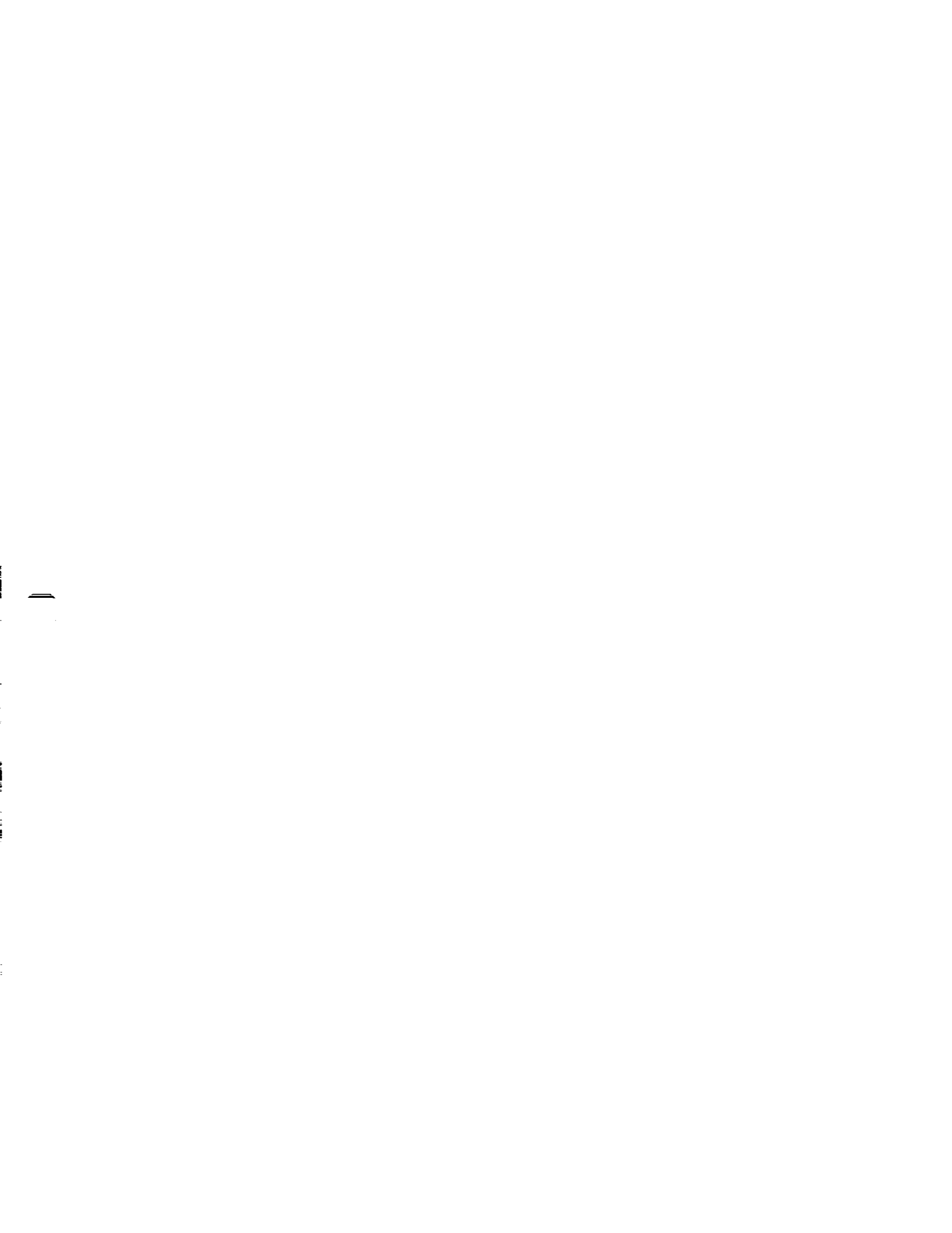

4-3-8 Programmed SCAN Memory

SCAN programs the section of RF memory locations 0 through 15.

KEY ENTRY

VFD (37) INDICATES



PROGRAM ?



2ND FUNCTION



SCAN 00 THRU 00

START MEMORY LOCATION STOP MEMORY LOCATION

The program will scan sequentially through the RF memory locations beginning with the start memory location entry and ending with the stop memory location. Upon reaching the programmed stop memory location, the scan sequence automatically repeats, beginning at the programmed start memory location.

KEY ENTRY

VFD (37) INDICATES



RESUME 0.0 SEC

The SCAN will remain at the RF memory location for the programmed resume time if squelch is broken.

4-3-9 Programmed STEP Memory

The STEP Key is used in conjunction with the RF and/or TONE functions. It provides a means of stepping the last executed frequency up or down at a pre-selected increment.

EXAMPLE: Programming STEP (RF)

KEY ENTRY

VFD (37) INDICATES

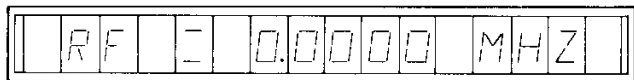
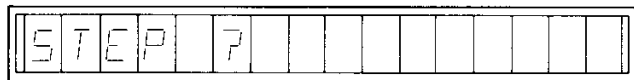
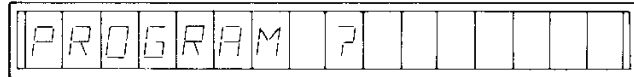

Enter desired step frequency.

Depress  Key.

EXAMPLE: Programming STEP (TONE)

KEY ENTRY

VFD (37) INDICATES

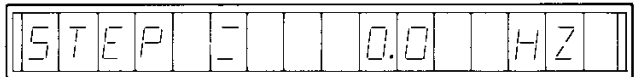
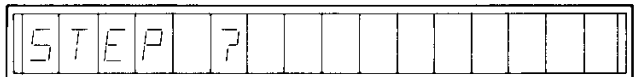
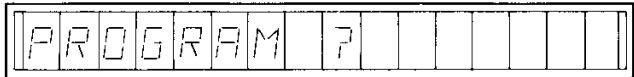

Enter desired step frequency.

Depress  Key.

NOTE

Do not depress ↑ or ↓ Key while programming STEP function.

4-4 EXECUTED DATA ENTRY

The "EXEC" Key retrieves and executes the programmed memory with no edit capability. To exit from this mode and return to the direct mode, depress ENTER Key twice.

4-4-1 EXECUTING RF Functions

KEY ENTRY

VFD (37) INDICATES

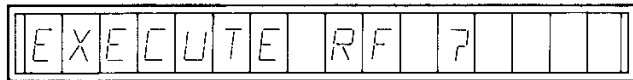
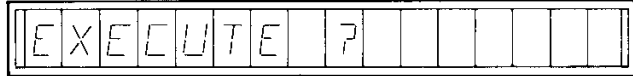

Select Desired RF memory location (Ref Table 4-1).

4-4-2 Executing TONE Functions

KEY ENTRY

VFD (37) INDICATES

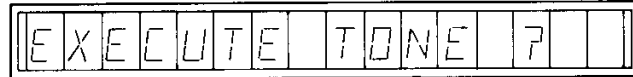
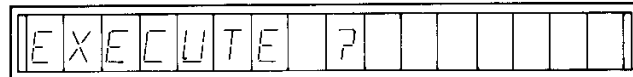

Select desired TONE memory location (Ref Table 4-1).

4-4-3 Executing DTMF/PULSE Functions

DTMF Function

KEY ENTRY

VFD (37) INDICATES



EXECUTE ?



EXECUTE DTMF ?

Select desired DTMF memory location (Ref Table 4-1).

IMTS (PULSE) Function

KEY ENTRY

VFD (37) INDICATES



EXECUTE ?



2ND FUNCTION



EXECUTE PULSE ?

Select desired IMTS memory location (Ref Table 4-1).

NOTE

The blinking digit is the one being executed.

4-4-4 Executing OFFSET Function.
(Active in DUP and DUP GEN Modes only).

KEY ENTRY

VFD (37) INDICATES

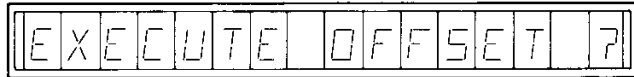
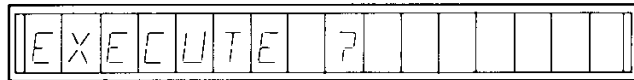

Select desired OFFSET memory location (Ref. Table 4-1).

4-4-5 Executing SCAN Function

KEY ENTRY

VFD (37) INDICATES

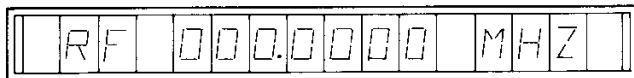
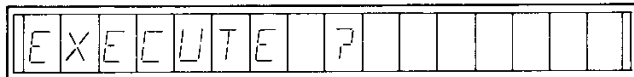

Reference paragraph 4-3-7 for a detailed explanation of the SCAN function.

4-4-6 Executing DCS Function

FM/AM-1200S/A will transmit entered DCS code only when MODE Selector Control (39) is in "GEN" position. With MODE Selector Control (39) in "REC" position, the VFD (37) will indicate any valid DCS code received in the program mode. It will not indicate an inverted code received or any alias codes. The VFD will display only DCS Standard codes listed in Table 4-2.

KEY ENTRY

VFD (37) INDICATES



EXECUTE ?



2ND FUNCTION



DCS 047 INVERT

Selected DCS Code Generated or Received

DCS --- INVERT

Prior to DCS Code Reception

023	$\overline{047}$	114	$\overline{712}$	147	$\overline{074}$	315	$\overline{423}$	445	$\overline{043}$	631	$\overline{606}$
025	$\overline{244}$	115	$\overline{152}$	205	$\overline{263}$	331	$\overline{465}$	464	$\overline{026}$	632	$\overline{624}$
026	$\overline{464}$	116	$\overline{754}$	223	$\overline{134}$	343	$\overline{532}$	465	$\overline{331}$	654	$\overline{743}$
031	$\overline{627}$	125	$\overline{365}$	226	$\overline{411}$	346	$\overline{612}$	466	$\overline{662}$	662	$\overline{466}$
032	$\overline{051}$	131	$\overline{364}$	243	$\overline{351}$	351	$\overline{243}$	503	$\overline{162}$	664	$\overline{311}$
043	$\overline{445}$	132	$\overline{546}$	244	$\overline{025}$	364	$\overline{131}$	506	$\overline{073}$	703	$\overline{565}$
047	$\overline{023}$	134	$\overline{223}$	245	$\overline{072}$	365	$\overline{125}$	516	$\overline{432}$	712	$\overline{114}$
051	$\overline{032}$	143	$\overline{412}$	251	$\overline{165}$	371	$\overline{734}$	532	$\overline{343}$	723	$\overline{431}$
054	$\overline{413}$	152	$\overline{115}$	261	$\overline{732}$	411	$\overline{226}$	546	$\overline{132}$	731	$\overline{155}$
065	$\overline{271}$	155	$\overline{731}$	263	$\overline{205}$	412	$\overline{143}$	565	$\overline{103}$	732	$\overline{261}$
071	$\overline{306}$	156	$\overline{265}$	265	$\overline{156}$	413	$\overline{054}$	606	$\overline{631}$	734	$\overline{371}$
072	$\overline{245}$	162	$\overline{503}$	271	$\overline{065}$	423	$\overline{315}$	612	$\overline{346}$	743	$\overline{654}$
073	$\overline{506}$	165	$\overline{251}$	306	$\overline{071}$	431	$\overline{723}$	624	$\overline{632}$	754	$\overline{116}$
074	$\overline{174}$	172		311	$\overline{064}$	432		627	$\overline{031}$		

Table 4-2 List of Current DCS Codes

NOTE

The bar above the number represents the binary complement. DO NOT use a number and its complement in the same system.

4-4-7 Executing T SEQ Function

Tone sequence will execute all preset tone memory locations (0 thru 15) which are programmed with an "ON TIME".

KEY ENTRY

VFD (37) INDICATES



E	X	E	C	U	T	E		P							
---	---	---	---	---	---	---	--	---	--	--	--	--	--	--	--



2	N	D		F	U	N	C	T	I	O	N				
---	---	---	--	---	---	---	---	---	---	---	---	--	--	--	--



T	O	N	E		0	0	0	0	0	0	.	S	I	N	E
---	---	---	---	--	---	---	---	---	---	---	---	---	---	---	---

NOTE

The tone displayed on the VFD (37) is the tone being executed. The last tone executed will remain displayed although the tone generator is turned off.

11/11/11

11/11/11

11/11/11

11/11/11

11/11/11

11/11/11

4-4-8 Executing STEP (RF and TONE) Function

This function steps the last executed frequency up or down at the pre-programmed increment.

RF STEP Function

KEY ENTRY

VFD (37) INDICATES

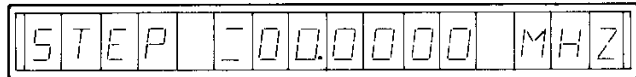
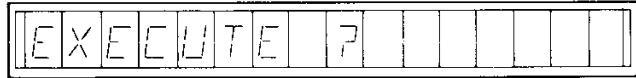

Depress ↑ or ↓ Key to step the RF Frequency up or down by the pre-programmed increment.

TONE STEP FUNCTION

KEY ENTRY

VFD (37) INDICATES



EXECUTE ?



2ND FUNCTION



STEP ?



STEP 00000.0 HZ

Depress \uparrow or \downarrow Key to step the Tone Frequency up or down by the pre-programmed increment.

NOTE

Once the STEP Function has been selected and the desired increment entered, the step function will remain valid until a Function Key is depressed.

4-4-9 Executing Variable IMTS Audio Function

NOTE

This function is based on the 2805/1500 type of signalling system, but allows any variable tone frequency and waveform to be used, including 2805/1500.

This function allows the variable tone entered in Tone Memory Location 0 to be used with any of the telephone numbers entered in DTMF/PULSE Memory Locations 0 through 15. The created pulse may be set at repetition rates of 10 or 20 pulses per second.

To use this function, program desired telephone numbers into DTMF/IMTS memory locations as shown in paragraph 4-3-3, and program desired variable tone frequency and waveform into Tone Memory Location 0 as shown in paragraph 4-3-2. Then perform the following steps:

KEY ENTRY

VFD (37) INDICATES

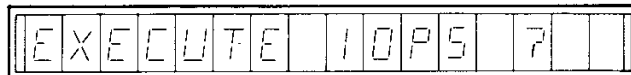
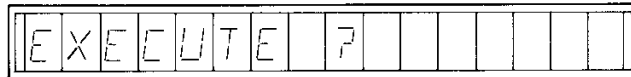

OR

OR



Press the key(s) corresponding to the desired DTMF/IMTS memory location (Ref. Table 4-1).

NOTE

The blinking digit is the one being executed.

If further telephone numbers are to be executed at the same pulse repetition rate and the same variable tone frequency and waveform, press the key(s) corresponding to the new DTMF/PULSE memory location.

4-5 RECEIVER OPERATION

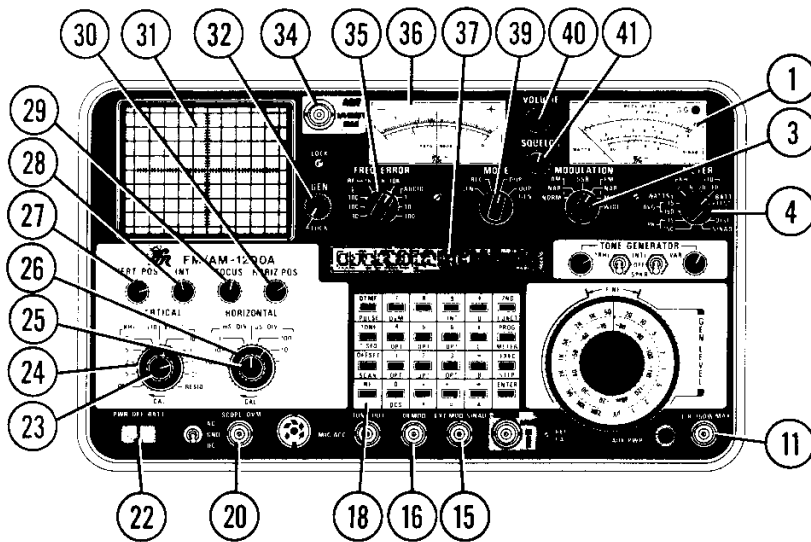

FM/AM-1200S/A CONNECTORS AND INDICATORS APPLICABLE TO RECEIVER OPERATION:

- 1 MODULATION Meter
- 11 T/R Connector
- 15 EXT MOD/SINAD Connector
- 16 DEMOD Connector
- 20 SCOPE/DVM Connector
- 31 CRT Display
- 34 ANT Connector
- 36 FREQ ERROR Meter
- 37 VFD

Figure 4-1 FM/AM-1200S/A Front Panel Controls
Applicable to Receiver Operation

CONTROL	SETTING
3 MODULATION Select Control	As req'd
4 Modulation METER Control	As req'd
18 Keyboard	As req'd
22 PWR/OFF/BATT Switch	"PWR" or "BATT"
23 Scope VERTICAL Attenuator Vernier Control	As req'd
24 VERTICAL Attenuator Selector Control	As req'd
25 Scope HORIZONTAL Sweep Vernier Control	As req'd
26 HORIZONTAL Sweep Selector Control	As req'd
27 VERT POS Control	As req'd
28 INT Control	As req'd
29 FOCUS Control	As req'd
30 HORIZ POS Control	As req'd
32 GEN/LOCK Control	Full ccw, detent
35 FREQ ERROR Meter Range Selector Control	As req'd
39 MODE Selector Control	"REC"
40 VOLUME Control	As req'd
41 Squelch Control	As req'd

Table 4-3 FM/AM-1200S/A Front Panel Controls
Applicable to Receiver Operation

4-5-1 GENERAL

The FM/AM-1200S/A contains a communications receiver capable of monitoring AM, FM, and SSB signals within a range of 250 kHz to 999.9999 MHz. Signals may be monitored "off-the-air" using an external antenna or by direct cable connection to the front panel T/R Connector (11). Table 4-4 defines the signal parameters which can be monitored using the receiver and associated monitoring functions.

SIGNAL CHARACTERISTIC(S):	MONITORING DEVICES	CONTROL SETTINGS:
Demodulated * AM, FM or SSB	MODULATION Meter (1) CRT (31) (Oscilloscope) VFD (37) Speaker	Modulation METER Control (4) to desired "kHz/%X10". MODULATION Select Control (3) as req'd. VERTICAL Attenuator Selector Control (24) to desired "kHz/%X10 position." Depress "2nd FUNCT" and "METER" Keys (in that order). Volume control (40) as req'd.
RF and AUDIO Error*	FREQ ERROR Meter (36) VFD (37)	FREQ ERROR Meter Range Selector Control (35) as req'd. Depress "2nd FUNCT" and "METER" Keys (in that order).
AUDIO Error* (Lissajou Pattern)	CRT (31)	HORIZONTAL Selector Control (26) to tone, VERTICAL Selector Control (24) to desired kHz/%X10.

* When the received signal input level is below the FM/AM-1200S/A squelch threshold, these monitoring functions will be disabled.

Table 4-4 Receiver Monitoring Capabilities

SIGNAL CHARACTERISTIC(S):	MONITORING DEVICE(S):	CONTROL SETTINGS:
Transmitter Power (WATTS) (T/R Connector (11) only)	MODULATION Meter (1) or VFD (37) CRT Display (31) (Spectrum Analyzer on FM/AM-1200S only)	Modulation Meter Control (4) to desired "WATTS" selection. Depress "2nd FUNCT" and "METER" Keys (in that order). HORIZONTAL Sweep Selector Control (26) clockwise to 1 MHz/DIV or less.
Relative Signal Strength	MODULATION Meter (1) VFD (37)	Modulation METER Control (4) to "SIG". Depress "2nd FUNCT" and "METER" keys (in that order)

Table 4-4 Receiver Monitoring Capabilities (Cont'd)

4-5-2 BASIC RECEIVER OPERATION

Basic operation of the FM/AM-1200S/A receiver is as follows:

STEP	PROCEDURE
1.	If signals are to be monitored "off-the-air", connect external antenna to ANT Connector (34); if signals are to be received by direct cable connection, apply signal to T/R Connector (11).

CAUTION

MAXIMUM CONTINUOUS INPUT TO ANTENNA CONNECTOR (34)
MUST NOT EXCEED 0.25 WATTS.

MAXIMUM INPUT TO T/R CONNECTOR (11) MUST NOT EXCEED
150 WATTS.

150 W = 1 minute "ON", 5 minutes "OFF".
50 W = Maximum continuous.

NOTE

For Accurate Power Meter measurements, set RF Level
Attenuator Control (9) to any position other than
-20 dBm.

STEP	PROCEDURE
2.	Using Keyboard (18), set FM/AM-1200S/A to desired RF frequency.

4-5-3 RECEIVING AM OR FM SIGNALS (OFF-THE-AIR)

STEP	PROCEDURE
1.	Perform "BASIC RECEIVER OPERATION" steps described in paragraph 4-5-2.
2.	Place MODULATION Select Control (3) to: <ol style="list-style-type: none"> "AM NORM" or "AM NAR" position, if receiving AM signals. "FM WIDE", "FM MID" or "FM NAR" position, if receiving FM signals.
3.	To aurally monitor received audio, adjust VOLUME Control (40) and SQUELCH Control (41) as required.
4.	Use monitoring features outlined in Table 4-4 to monitor desired signal parameters.

4-5-4 RECEIVING SSB SIGNALS (OFF-THE-AIR)

STEP	PROCEDURE
1.	Perform "BASIC RECEIVER OPERATION" steps described in paragraph 4-5-2.
2.	Place MODULATION Select Control (3) to "SSB" position.
3.	To aurally monitor audio, adjust VOLUME Control (40) and SQUELCH control (41) as required.
4.	Use GEN/LOCK Control (32) as a clarifier.

MODULATION SELECT CONTROL POSITION	DEMODULATION MODE	PRE-DETECTION BANDWIDTH	POST-DETECTION BANDWIDTH
AM			
NAR	AM	6 kHz	8 kHz
NORM	AM	15 kHz	8 kHz
SSB	SSB	6 kHz	8 kHz
FM			
NAR	FM	15 kHz	8 kHz
MID	FM	200 kHz	8 kHz
WIDE	FM	200 kHz	80 kHz

Table 4-5 Modulation Select Control Positions

4-5-5 TESTING AM OR FM TRANSMITTERS

STEP	PROCEDURE
------	-----------

CAUTION

MAXIMUM INPUT TO T/R CONNECTOR (11) MUST NOT EXCEED 150 WATTS.

MAXIMUM TIME LIMITS FOR MEASUREMENT OF TRANSMITTER OUTPUT USING T/R CONNECTOR (11) IS:

>150 W = 1 MINUTE "ON", 5 MINUTES "OFF".

↓

50 W = MAXIMUM CONTINUOUS.

1. Perform "BASIC RECEIVER OPERATION" steps described in paragraph 4-5-2.

NOTE

Connect 50Ω coaxial cable between output of transmitter under test and FM/AM-1200S/A T/R Connector (11).

2. Position MODULATION Select Control (3) to:
 - a. AM "NORM" or "NAR" position if testing AM transmitters.
 - b. FM "NAR", "MID" or "WIDE" position, if testing FM transmitters.
3. Use monitoring features outlined in Table 4-7 to monitor desired signal parameters.

4-5-6 MEASURING AM OR FM TRANSMITTER DISTORTION

STEP	PROCEDURE
------	-----------

1. Perform "BASIC RECEIVER OPERATION" steps described in paragraph 4-5-2.

NOTE

Connect 50Ω coaxial cable between output of transmitter under test and FM/AM-1200S/A T/R Connector (11).

STEP

PROCEDURE

2. Modulate transmitter under test with a fixed 1 kHz tone.

NOTE

FM/AM-1200S/A 1 kHz Tone Generator (fixed) function should be used as a modulation source.

Measurement accuracy is dependent on accuracy of 1 kHz tone.

3. Position Modulation METER Control (4) to "DIST".
4. Connect coax cable between FM/AM-1200S/A DEMOD Connector (16) and EXT MOD/SINAD Connector (15).
5. Monitor DIST Level on top scale of MODULATION Meter (1).
6. Place VERTICAL Attenuator Selector Control (24) to "RESID" position to observe residual distortion on oscilloscope.

4-6 RF SIGNAL GENERATOR OPERATION (SIMPLEX)

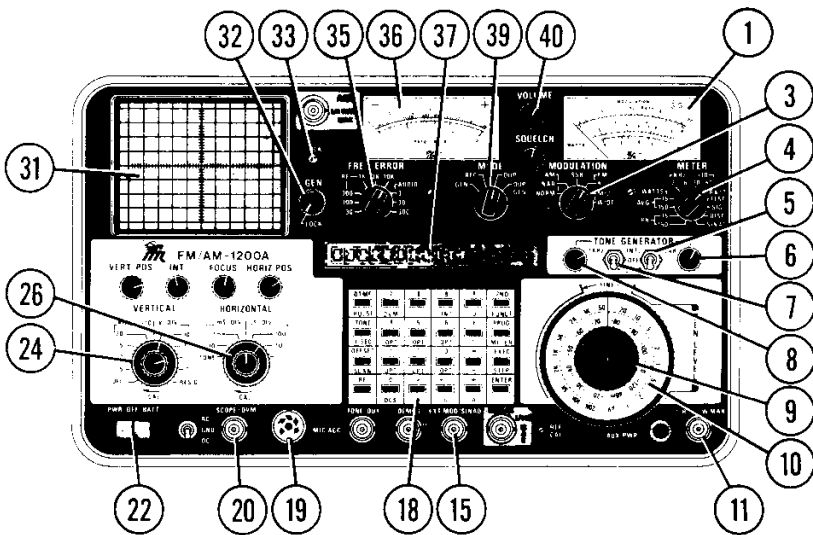

FM/AM-1200S/A CONNECTORS AND INDICATORS APPLICABLE TO RF SIGNAL GENERATOR OPERATION:

- 1 MODULATION Meter
- 11 T/R Connector
- 15 EXT MOD/SINAD Connector
- 19 MIC/ACC Connector
- 20 SCOPE/DVM Connector
- 31 CRT Display
- 33 LOCK Lamp
- 36 FREQ ERROR Meter
- 37 VFD

Figure 4-2 FM/AM-1200S/A Front Panel Controls Applicable to RF Signal Generator Operation

CONTROL	SETTING
3 MODULATION Select Control	"FM NAR"
4 Modulation METER Control	"kHz/%X10 position 6"
5 VAR Tone Selector Switch	"OFF"
6 VAR Tone Level Control	As req'd
7 1 kHz Tone Selector Switch	"OFF"
8 1 kHz Tone Level Control	As req'd
9 RF Level Attenuator	"-50 dBm"
10 RF Level Attenuator Vernier Control	".5K μ V"
18 Keyboard	"RF Frequency 150.2000 MHz"
22 PWR/OFF/BATT Switch	"PWR" or "BATT"
24 VERTICAL Attenuator Selector Control	"2 kHz/%X10"
26 HORIZONTAL Sweep Selector Control	"1 mS/DIV"
32 GEN/LOCK Control	"LOCK"
35 FREQ ERROR Meter Range Selector Control	"10K"
39 MODE Selector Control	"GEN"
40 VOLUME Control	As req'd

Table 4-6 FM/AM-1200S/A Front Panel Controls Applicable to RF Signal Generator Operation

4-6-1 GENERAL

The FM/AM-1200S/A RF signal generator is capable of generating calibrated amplitude signals within a range of 250 kHz to 999.9999 MHz, in 100 Hz steps. The signal generator can be used to stimulate external devices by generating modulated or unmodulated signals, while the FM/AM-1200S/A receiver is simultaneously monitoring the generator. Modulation signals for the generated carrier are available from the FM/AM-1200S/A internal tone generators or from external audio sources. A microphone input connector is also available for applying voice modulation. The generated signals are transmitted out the FM/AM-1200S/A front panel T/R Connector (11), at an output level which is continuously variable from -20 to -127 dBm (using RF Level Attenuator Controls (9) and (10)).

Table 4-7 outlines the parameters of the generated output, which can be monitored by the FM/AM-1200S/A receiver circuits during generator operation.

SIGNAL CHARACTERISTICS:	MONITORING DEVICE(S):	CONTROL SETTINGS:
Demodulated Audio	MODULATION Meter (1) CRT (31) (Oscilloscope) VFD (37) SPEAKER	Modulation METER Control (4) to desired "kHz/%X10". MODULATION Select Control (3) as required. VERTICAL Attenuator Selector Control (24) to kHz/%X10 position. HORIZONTAL Sweep Selector Control (26) to mS/DIV or μ S/DIV (FM/AM-1200A only) position. Depress "2ND FUNCT" and "METER" Keys (in that order.) Volume Control (40) as required.

Table 4-7 Receiver Monitoring Capabilities of Generated Output

Table 4-6 (Cont'd)

SIGNAL CHARACTERISTICS:	MONITORING DEVICE(S):	CONTROL SETTINGS:
#RF ERROR or *AUDIO ERROR	FREQ ERROR Meter (36) VFD (37)	FREQ ERROR Meter Range Selector Control (35) as req'd. Depress "2ND FUNCT" and "METER" Keys (in that order).

Used with GEN/LOCK Control (32)

* Audio error is measured through EXT MOD/SINAD Connector (15).

Table 4-7 Receiver Monitoring Capabilities of Generated Output

4-6-2 SIGNAL GENERATOR OPERATION (SIMPLEX)

STEP	PROCEDURE
------	-----------

1. Position front panel controls as indicated in Table 4-5.

NOTE

FM/AM-1200S/A is now generating a carrier signal at a frequency and output level of 150.2 MHz @ 500 μ V.

If a signal greater than 100 mW is applied to the T/R Connector (11) while the FM/AM-1200S/A is generating, the set will automatically switch to the receive mode and only monitor the signal(s) applied to this connector.

4-6-3 GENERATING AM OR FM MODULATED RF SIGNALS

STEP	PROCEDURE
------	-----------

1. Perform "STEPS IN SIGNAL GENERATOR OPERATION" (Ref. paragraph 4-6-2).
2. Apply FM modulation signal to carrier as follows:
 - a. Using Keyboard (18), depress "TONE" Key and enter desired modulation frequency and wave shape.

- b. Select "INTL" with VAR Tone Selector Switch (5) and adjust VAR Tone Level Control (6) for 5 kHz as displayed on MODULATION Meter (1) and Scope Display (31).
- c. If 1 kHz Tone Generator output is preferred, select "INTL" with 1 kHz Tone Selector Switch and adjust 1 kHz Tone Level Control (8) for 5 kHz as displayed on MODULATION Meter (1) and Scope Display (31).

NOTE

If both tone generators are used as modulation sources, the MODULATION Meter (1) and CRT Display (31) will display the composite modulation signal produced by both tone generators. To monitor either individual modulation signal, one generator must be turned off.

- d. The FM/AM-1200S/A is now generating a carrier signal with 5 kHz FM deviation. Use monitoring features outlined in Table 4-7 to monitor desired signal parameters.

NOTE

For AM modulation, place MODULATION Select Control (3) to "AM NORM" position. Adjust either the 1 kHz or VAR Tone Level Controls for proper percent modulation as viewed on MODULATION Meter (1) and Scope Display (31).

3. Modulating the FM/AM-1200S/A Generator with DTMF.
 - a. Program desired telephone number into DTMF memory location. When desired telephone number is executed, it will be modulated at approximately 3.5 kHz.
4. Modulating the FM/AM-1200S/A Generator with DCS.
 - a. Program DCS code number into memory. To monitor DCS code on FM/AM-1200S/A, place VAR Tone Selector Switch (5) to "INTL" and adjust VAR Tone Level Control for desired modulation level.

4-6-4 EXTERNALLY MODULATING RF SIGNAL GENERATOR

STEP	PROCEDURE
1.	Perform steps in "SIGNAL GENERATOR OPERATION".
2.	Apply external modulation signal to EXT MOD/SINAD Connector (15).

NOTE

Insure VAR Tone Selector Switch (5) and 1 kHz Tone Selector Switch (7) are positioned to "OFF".

3. Adjust output of applied modulation signal to desired modulation level, as reflected on MODULATION Meter (1) and Scope Display (31).

4-6-5 VOICE MODULATING RF SIGNAL GENERATOR

STEP	PROCEDURE
1.	Perform steps in "SIGNAL GENERATOR OPERATION".
2.	Connect external microphone to MIC/ACC Connector (19).
3.	Press PTT (Press-To-Talk) Switch (on microphone) and speak into microphone. Use monitoring features outlined in Table 4-7 to monitor voice modulation characteristics.

NOTE

Diode speech limiting is incorporated within FM/AM-1200S/A circuitry for control of peak modulation. The limiter is set for 6 kHz deviation.

Whenever microphone is keyed, the FM/AM-1200S/A will automatically switch to the generate mode of operation, if the MODE Selector Control (39) is in the "REC" or "DUP" position. The generate mode cannot be overridden by applying power transmission at the T/R Connector (11).

4-6-6 VARIABLE GENERATE

This feature allows the generator to be moved off center frequency a minimum of ± 10 kHz and the EXT MOD Connector (15) to be used for DC coupling.

STEP	PROCEDURE
1.	Set front panel controls to the positions listed in Table 4-6.
2.	(FM/AM-1200S only). Position HORIZONTAL Sweep Selector Control (26) to "10 kHz/Div" and center display using HORIZ POS Control (30).
3.	Rotate GEN/LOCK Control (32) out of the "LOCK" (detent) position and observe generator frequency change on FREQ ERROR Meter (36) and analyzer display (FM/AM-1200S only).
4.	Place GEN/LOCK Control (32) to "LOCK" (detent) and observe that FREQ ERROR Meter (36) goes back to zero and analyzer display is centered (FM/AM-1200S only).

4-6-7 MEASURING UUT RECEIVER SINAD SENSITIVITY

STEP	PROCEDURE
1.	Connect 50 Ω coaxial cable between FM/AM-1200S/A T/R Connector (11) and RF input of receiver under test.
NOTE	
For UUT SINAD measurements, the FM/AM-1200S/A internal tone generator (fixed) should be used as a modulation source. A modulation frequency of 1000.0 Hz is required.	
2.	Connect audio output of receiver under test to EXT/MOD/SINAD Connector (15) and place Modulation METER Control (4) to "SINAD" position.
3.	Adjust RF Level Attenuator Control (9) for an output level of 500 μ V.
4.	Slowly decrease FM/AM-1200S/A RF output level until MODULATION Meter (1) displays desired SINAD value.

NOTE

The setting of RF Level Attenuator Control (9) and RF Level Attenuator Vernier Control (10) represents SINAD sensitivity of receiver under test.

4-7 DUPLEX OPERATION

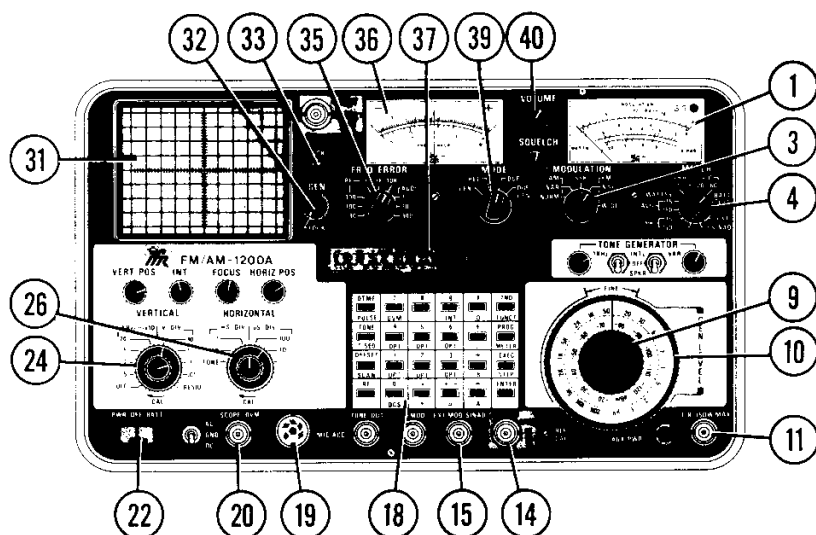

FM/AM-1200S/A CONNECTORS AND INDICATORS APPLICABLE TO DUPLEX OPERATION:

- 1 MODULATION Meter
- 11 T/R Connector
- 14 DUPLEX Output Connector
- 15 EXT MOD/SINAD Connector
- 19 MIC/ACC Connector
- 20 SCOPE/DVM Connector
- 31 CRT Display
- 33 LOCK Lamp
- 36 FREQ ERROR Meter
- 37 VFD

Figure 4-3 FM/AM-1200S/A Front Panel Controls Applicable to Duplex Operation

CONTROL	SETTING
3 MODULATION Select Control	"FM NAR"
4 Modulation METER Control	"kHz/%X10 position 6"
9 RF Level Attenuator Control	"-50 dBm"
10 RF Level Attenuator Vernier Control	".5 V"
18 Keyboard	"RF Frequency 150.2000 MHz"
22 PWR/OFF/BATT Switch	"PWR" or "BATT"
24 VERTICAL Attenuator Selector Control	"2 kHz/%X10"
26 HORIZONTAL Sweep Selector Control	"1 mS/Div"
32 GEN/LOCK Control	"LOCK"
35 FREQ ERROR Meter Range Selector Control	"10K"
39 MODE Selector Control	"GEN"
40 VOLUME Control	as req'd

Table 4-8 FM/AM-1200S/A Front Panel Controls Applicable to Duplex Operation

NOTE

For Accurate Power Meter measurements, set RF Level Attenuator Control (9) to any position other than -20 dBm.

4-7-1 GENERAL

In the Duplex mode of operation, the FM/AM-1200S/A has the capability of generating and receiving signals simultaneously. While the FM/AM-1200S/A receiver is monitoring the power, modulation and frequency characteristics of the UUT transmitter, the FM/AM-1200S/A offset generator is simultaneously transmitting to the UUT receiver with a signal at a fixed output level. This signal is not affected by the operation of the UUT transmitter. FM/AM-1200S/A duplexer accuracy (setting up on desired frequency) is ± 1.3 kHz

NOTE

The FM/AM-1200S/A contains a duplex system which is FM modulated only.

The FM/AM-1200A has an output level at the DUPLEX Output Connector of -60 dBm ± 10 dB.

The FM/AM-1200S has two output levels available at the DUPLEX Output Connector:

DUPLEX HIGH Mode: -15 dBm (± 10 dB) @ ± 49.99 MHz
from Receive Frequency

DUPLEX LOW Mode: -25 dB below DUPLEX HIGH at
the same frequency

Perform the procedure in paragraph 4-6-3 "GENERATING FM MODULATED SIGNALS" before continuing on with this procedure.

NOTE

4-7-2 through 4-7-6 apply to FM/AM-1200A Duplex operation only.

4-7-7 through 4-7-10 apply to FM/AM-1200S Duplex operation only.

4-7-2 DUPLEX TESTING USING SEPARATE TRANSMIT/RECEIVE LINES (FULL DUPLEX OPERATION) (FM/AM-1200A ONLY)

In this mode, the UUT transmitter output is applied to the FM/AM-1200A at the T/R Connector (11). The FM/AM-1200A offset generator output (available at the DUPLEX Output Connector (14)), at a fixed level, is applied to the RF input of the UUT receiver.

CAUTION

DO NOT TRANSMIT INTO DUPLEX OUTPUT CONNECTOR (14), AS CONNECTOR IS NOT PROTECTED AGAINST RF INPUTS ABOVE 0.25 WATTS.

4-7-3 "OFF-THE-AIR" DUPLEX TESTING (FM/AM-1200A ONLY)

In this mode, the output of the UUT transmitter is monitored "off-the-air" at the FM/AM-1200A ANT Connector (34), while the FM/AM-1200A offset generator output (available at the Duplex Output Connector (14) or T/R Connector (11)) is applied to the UUT receiver input.

CAUTION

DO NOT TRANSMIT INTO ANTENNA CONNECTOR (34);
RF INPUTS IN EXCESS OF 0.25 WATTS MAY CAUSE
DAMAGE TO FM/AM-1200A.

4-7-4 DUPLEX TESTING USING COMMON TRANSMIT/RECEIVE LINE (HALF DUPLEX OPERATION FM/AM-1200A ONLY)

When testing a duplex transceiver with a single transmit/receive I/O port, a common receive/transmit line is connected between the UUT RF I/O port and the FM/AM-1200A T/R Connector (11).

CAUTION

DO NOT TRANSMIT INTO DUPLEX OUTPUT CONNECTOR (14), AS CONNECTOR IS NOT PROTECTED AGAINST RF INPUTS ABOVE 0.25 WATTS.

NOTE

The offset transmitted out DUPLEX Output Connector (14) is a fixed -60 dB level.

The offset transmitted out T/R Connector (11) is a fixed -80 dB level.

The RF frequency entered in the FM/AM-1200A is the UUT transmit frequency. OFFSET = UUT receive frequency minus UUT transmit frequency. (OFFSET can be (-) negative.)

4-7-5 DUPLEX TESTING (FM/AM-1200A ONLY)

Place MODE Selector Control (39) to "DUP" Position.

EXAMPLE: Testing a Duplex transceiver
UUT XMT FREQ = 157.77 MHz
UUT REC FREQ = 152.51 MHz

ENTER:        (UUT XMT Freq)

NOTE

OFFSET = 152.51 MHz (UUT Rec Freq) - 157.77 MHz
(UUT XMT Freq) (OFFSET = -5.26 MHz)

ENTER:



NOTE

Use  Key until (-) sign appears in front of offset frequency.

NOTE

A generated RF frequency of 152.51 MHz with 5 kHz deviation @ -60 dBm is present at DUPLEX Output Connector (14). T/R Connector (11) is set to receive an RF frequency of 157.77 MHz. A signal of 152.51 MHz with 5 kHz deviation @ -80 dBm is also present at the T/R Connector (11).

4-7-6 DUPLEX GENERATE MODE (FM/AM-1200A ONLY)

In Duplex Generate Mode of operation, the signal is present at the T/R Connector (11) only. There is NO signal present at the DUPLEX Output Connector (14). The output frequency at the T/R Connector (11) is the RF setting plus the OFFSET frequency with the output level controlled by the RF Level attenuator control (9) and RF Level Attenuator Vernier Control (10). The FM/AM-1200A receiver will monitor the FM/AM-1200A generator.



NOTE

FM/AM-1200S/A is forced into the generate mode and will not switch to receive mode when transmitting into T/R Connector (11).

EXAMPLE: RF Setting = 157.77 MHz
OFFSET Setting: -5.26 MHz
Output Frequency @ T/R Connector (11) = 152.51 MHz

4-7-7 SELECTING "DUPLEX HIGH" OR "DUPLEX LOW" (FM/AM-1200S ONLY)

STEP _____ PROCEDURE _____

1. Place MODE Selector Control (39) to "DUP" position.
2. Press   to select DUPLEX HIGH (-15 dBm ±10 dB) or DUPLEX LOW (-40 dBm ±15 dB) output levels.



a. The VFD will display:

D	U	P	L	E	X		H	I	G	H					
---	---	---	---	---	---	--	---	---	---	---	--	--	--	--	--

or

D	U	P	L	E	X		L	O	W						
---	---	---	---	---	---	--	---	---	---	--	--	--	--	--	--

b. The word "ON" following one of these selections will indicate the presently selected DUPLEX operating mode.

3. Use the  and  to rotate between the two modes as displayed on the VFD.

4. Press  to change from the current operating mode to the one displayed on the VFD. The word "ON" will appear on that display.

NOTE

If no key is pressed within 5 seconds after the "DUPLEX HIGH" or "DUPLEX LOW" message appears on the VFD, the FM/AM-1200S will default to its last setting and VFD display.

4-7-8 DUPLEX TESTING METHODS (FM/AM-1200S ONLY)

Three possible methods of UUT Duplex Testing using the FM/AM-1200S are:

A. DUPLEX TESTING USING SEPARATE TRANSMIT/RECEIVE LINES (FULL DUPLEX OPERATION)

In this mode, the UUT transmitter output is applied to the FM/AM-1200S at the T/R Connector (11). The FM/AM-1200S offset generator output (available at the DUPLEX Output Connector (14)), at a fixed level, is applied to the RF input of the UUT receiver.

CAUTION

DO NOT TRANSMIT INTO DUPLEX OUTPUT CONNECTOR (14); CONNECTOR IS NOT PROTECTED AGAINST RF INPUTS ABOVE 0.25 WATTS.

B. "OFF-THE-AIR" DUPLEX TESTING

In this mode, the output of the UUT transmitter is monitored "off-the-air" at the FM/AM-1200S ANT Connector (34), while the FM/AM-1200S offset generator output (available at the Duplex Output Connector (14) or T/R Connector (11)) is applied to the UUT receiver input.

CAUTION

DO NOT TRANSMIT INTO ANTENNA CONNECTOR (34): RF INPUTS IN EXCESS OF 0.25 WATTS MAY CAUSE DAMAGE TO FM/AM-1200S.

C. DUPLEX TESTING USING COMMON TRANSMIT/RECEIVE LINE (HALF DUPLEX OPERATION)

When testing a duplex transceiver with a single transmit/receive I/O port, a common receive/transmit line is connected between the UUT RF I/O port and the FM/AM-1200S T/R Connector (11).

CAUTION

DO NOT TRANSMIT INTO DUPLEX OUTPUT CONNECTOR (14); CONNECTOR IS NOT PROTECTED AGAINST RF INPUTS ABOVE 0.25 WATTS.

NOTE

The offset transmitted out the DUPLEX Output Connector (14) of the FM/AM-1200S is at -15 dBm (± 10 dB) in the DUPLEX HIGH mode or -40 dBm (± 15 dB) in the DUPLEX LOW mode.

The offset transmitted out T/R Connector (11) is a fixed -85 dBm (± 10 dB) level.

The RF frequency entered in the FM/AM-1200S is the UUT transmit frequency. $\text{OFFSET} = \text{UUT receive frequency} - \text{UUT transmit frequency}$. (OFFSET can be (-) negative.)

4-7-9 DUPLEX TEST (FM/AM-1200S ONLY)

EXAMPLE: Testing a Duplex transceiver

UUT XMT FREQ = 157.77 MHz

UUT REC FREQ = 152.51 MHz

STEP _____ PROCEDURE _____

1. Place MODE Selector Control (39) to "DUP" position.

2. Enter:   and 







until VFD displays:







Press: 

VFD will display:



3. Enter        (UUT XMT Freq)

OFFSET = 152.51 MHz (UUT Rec Freq) = 157.77 MHz
(UUT XMT Freq) (OFFSET = -5.26 MHz)

4. Enter:     

Use  Key until (-) sign appears in front of offset frequency.

NOTE

A generated RF frequency of 152.51 MHz with a 5 kHz deviation @ -15 dBm (± 10 dB) (DUPLEX HIGH mode) or -40 dBm (± 15 dB) (DUPLEX LOW mode) is present at the DUPLEX Output Connector (14). T/R Connector (11) will receive an RF frequency of 157.77 MHz. A signal of 152.51 MHz with a 5 kHz deviation @ -85 dBm (± 10 dB) is also present at the T/R Connector (11).

4-7-10 DUPLEX GENERATE MODE (FM/AM-1200S ONLY)

In Duplex Generate Mode of operation, the signal is present at the T/R Connector (11) only. There is NO signal present at the DUPLEX Output Connector (14). The output frequency at the T/R Connector (11) is the RF setting plus the OFFSET frequency with the output level controlled by the RF Level Attenuator Control (9) and RF Level Attenuator Vernier Control (10). The FM/AM-1200S receiver will monitor the FM/AM-1200S generator.

NOTE

FM/AM-1200S is forced into the generate mode and will not switch to receive mode when transmitting into T/R Connector (11).

EXAMPLE: RF Setting = 157.77 MHz
OFFSET Setting = -5.26 MHz
Output Frequency @ T/R Connector (11) = 152.51 MHz

4-8 OSCILLOSCOPE OPERATION

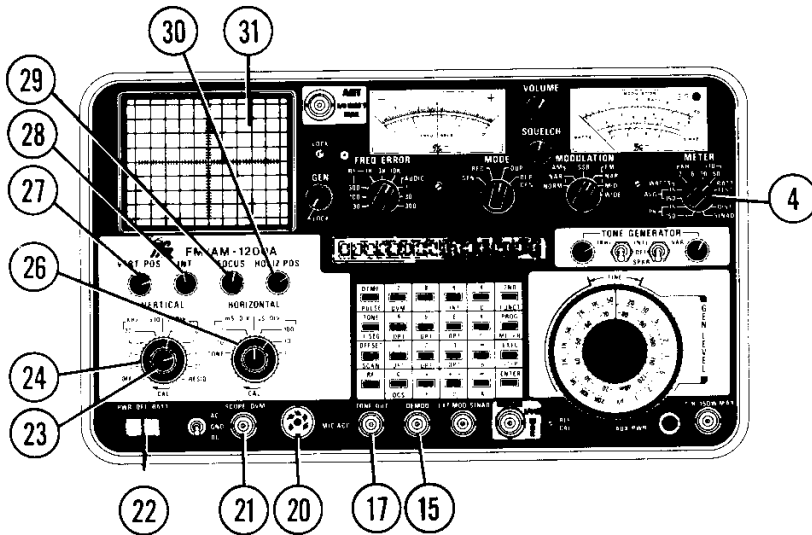

FM/AM-1200S/A CONNECTORS AND INDICATORS APPLICABLE TO OSCILLOSCOPE OPERATION:

- 15 EXT MOD/SINAD Connector
- 17 TONE OUT Connector
- 20 SCOPE/DVM Connector
- 31 CRT Display

Figure 4-4 FM/AM-1200S/A Front Panel Controls Applicable to Oscilloscope Operation

CONTROL	SETTING
4 Modulation METER Control	As req'd
21 AC/GND/DC Switch	As req'd
22 PWR/OFF/BATT Switch	"PWR" or "BATT"
23 VERTICAL Attenuator Vernier Control	"CAL"
24 VERTICAL Attenuator Selector Control	"1 V/Div"
26 HORIZONTAL Sweep Selector Control	"1 mS/Div"
27 VERT POS Control	Ctr Trace
28 INT Control	As req'd
29 FOCUS Control	As req'd
30 HORIZ POS Control	Ctr Trace

Table 4-9 FM/AM-1200S/A Front Panel Controls Applicable to Oscilloscope Operation

4-8-1 GENERAL

Table 4-9 lists the front panel controls which are used in the Oscilloscope function of the FM/AM-1200S/A. For oscilloscope operation, the HORIZONTAL Sweep Selector Control (26) must be in "mS/Div" or "μS/DIV" position. The VERTICAL Attenuator Selector Control (24) "kHz/%X10" position is for internal demodulated audio and "V/Div" position is for external scope inputs. All other controls are similar to those found on most conventional oscilloscopes.

4-8-2 EXTERNAL OSCILLOSCOPE OPERATION

The FM/AM-1200S/A Oscilloscope is a general purpose DC to 1 MHz bandwidth single trace oscilloscope with automatic triggering. Any external input to the scope must be applied at the front panel SCOPE/DVM Connector (20).

STEP	PROCEDURE
1.	Place the FM/AM-1200S/A front panel controls to the settings listed in Table 4-9.
2.	Connect TONE OUT Connector (17) to SCOPE/DVM Connector (20).
3.	Turn 1 kHz TONE Selector Switch (7) to "INTL" position.
4.	Adjust 1 kHz TONE LEVEL Control (8) for a viewed sine wave on CRT Display (31).

NOTE

When AC/GND/DC Switch (21) is in "GND" position, the external input is removed from the Oscilloscope.

4-8-3 INTERNAL OSCILLOSCOPE OPERATION

The VERTICAL Attenuator Selector Control (24) must be in one of the four "kHz/%X10" positions for internal oscilloscope operation.

STEP	PROCEDURE
1.	Place the FM/AM-1200S/A front panel controls to the settings listed in Table 4-9.
2.	Set Vertical Attenuator Selector Control (24) to "2 kHz/%X10" position.
3.	Set FM/AM-1200S/A controls for 5 kHz FM deviation. (Ref. paragraph 4-6, RF Signal Generation Operation (Simplex).)
4.	The CRT now displays (+) and (-) 5 kHz deviation.

NOTE

For AM modulation, the demodulated audio displayed on CRT will read twice the percentage of modulation.

4-8-4 RESIDUAL DISTORTION

The "RESID" position of the VERTICAL Attenuator Selector Control (24) allows the display of the residual distortion or noise of the UUT, as received at the EXT MOD/SINAD Connector (15). The "RESID" position is only valid when the Modulation METER Control (4) is in "SINAD" or "DIST" position.

4-8-5 TONE GENERATOR

The "TONE" position of the HORIZONTAL Sweep Selector Control (26) applies the output of the Programmable and/or Fixed (1 kHz) Tone Generators to the horizontal deflection circuits of the CRT. This function is useful for measuring the frequency of demodulated audio or externally applied audio signals, using the Lissajou method of frequency comparison.

4-9 SPECTRUM ANALYZER OPERATION (FM/AM-1200S ONLY)

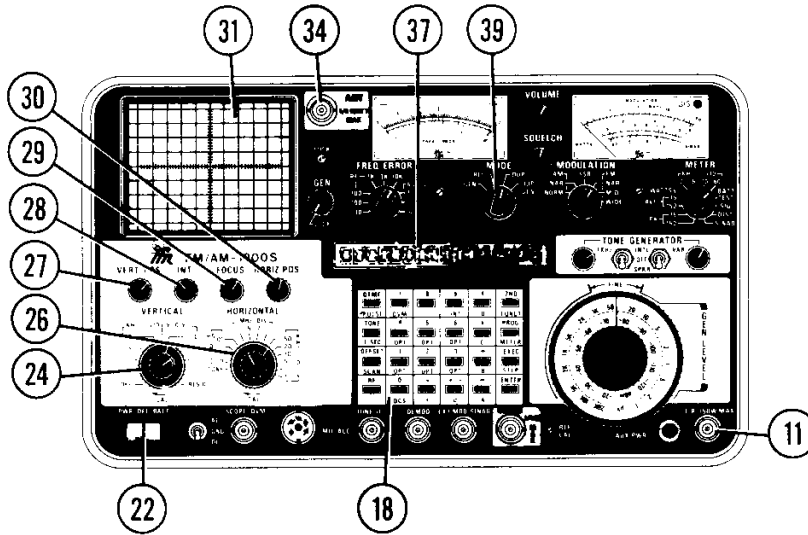

FM/AM-1200S CONNECTORS AND INDICATORS APPLICABLE TO SPECTRUM ANALYZER OPERATION:

- 11 T/R Connector
- 31 CRT Display
- 34 ANT Connector
- 37 VFD

Figure 4-5 FM/AM-1200S Front Panel Controls Applicable to Spectrum Analyzer Operation

CONTROL	SETTING
18 Keyboard	As req'd
22 PWR/OFF/BATT Switch	"PWR" or "BATT"
24 VERTICAL Attenuator Selector Control	Any position except "OFF"
26 HORIZONTAL Sweep Selector Control	"1 MHz/Div"
27 VERT POS Control	"Mid Range"
28 INT Control	As req'd
29 FOCUS Control	As req'd
30 HORIZ POS Control	"Mid Range"
39 MODE Selector Control	As req'd

Table 4-10 FM/AM-1200S Front Panel Controls Applicable to Spectrum Analyzer Operation

4-9-1 GENERAL

Table 4-10 lists the FM/AM-1200S front panel controls applicable to the Spectrum Analyzer function. The FM/AM-1200S Spectrum Analyzer is a general purpose analyzer capable of monitoring RF signals within a range of 250 kHz to 999.9999 MHz. The HORIZONTAL Sweep Selector Control (26) must be in one of the MHz/Div or kHz/Div positions for spectrum analyzer operation. The RF frequency displayed on VFD (37) is the spectrum analyzer center frequency. The spectrum analyzer bandwidth is automatically selected.

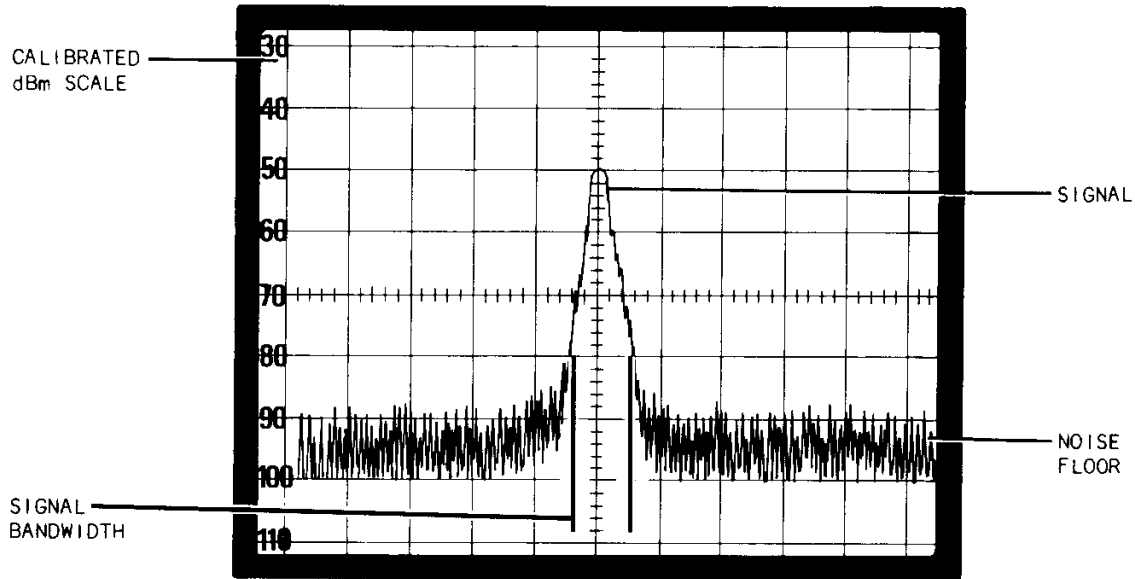

Figure 4-6 Typical Spectrum Analyzer Display

VERT POS Control (27)

Controls Spectrum Analyzer vertical position and allows adjustment of reference level by one scale division over range of vertical axis.

HORIZ POS Control (30)

Controls horizontal position of Spectrum Analyzer and limits this control to one division left or right.

HORIZONTAL Sweep Selector Control (26)

HORIZONTAL/DISPERSION	BANDWIDTH
1 kHz/DIV	300 Hz
2 kHz/DIV	300 Hz
5 kHz/DIV	3 kHz
10 kHz/DIV	3 kHz
20 kHz/DIV	3 kHz
50 kHz/DIV	30 kHz
.1 MHz/DIV	30 kHz
.2 MHz/DIV	30 kHz
.5 MHz/DIV	30 kHz
1 MHz/DIV	30 kHz

Table 4-11 Horizontal Sweep Selector Control (Analyzer Dispersion Control) Settings

4-9-2 Spectrum Analyzer Operation

To calibrate analyzer base line, perform the following steps:

STEP	PROCEDURE
1.	Place the FM/AM-1200S front panel controls to the settings listed in Table 4-10.
2.	Set HORIZONTAL Sweep Selector Control (26) to any mS/Div Position.
3.	Adjust VERT POS Control (27) to center trace directly over center horizontal graticule.
4.	Set HORIZONTAL Sweep Selector Control (26) to "1 MHz/Div" Position and MODE Selector Control (39) to "GEN" Position.
5.	Adjust HORIZ POS Control (30) to center signal directly over center vertical graticule.

With the spectrum analyzer baseline calibrated, a -30 dBm RF signal applied to ANT Connector (34) will indicate a full scale display.

4-10 TONE GENERATOR OPERATION

The FM/AM-1200S/A has two independently controlled tone generators (one variable and one fixed). The variable tone generator is capable of generating modulation sinewave signals within a range of 2 Hz to 30 kHz (in 0.1 Hz increments). All other waveform modulation signals are within a range of 2 Hz to 10 kHz (in 0.1 Hz increments). The fixed tone generator output is a 1 kHz sinewave. The frequency and wave shape of the variable tone generator is selected by the FM/AM-1200S/A Keyboard (18) and displayed on the VFD (37) when the Keyboard "TONE" key mode is selected. The output level of each tone generator can be individually controlled.

4-11 BASIC RS-232 OPERATION

This paragraph contains basic instructions for operating the FM/AM-1200S/A using an RS-232 or GPIB compatible external device. Using these instructions, the operator can select any available parameter of the following FM/AM-1200S/A functions:

DTMF TONE	OFFSET RF	IMTS (PULSE) TONE WAVEFORM	METER DCS	MODULATION
--------------	--------------	-------------------------------	--------------	------------



4-11-1 FM/AM-1200S/A INITIALIZATION

The initial communication between the FM/AM-1200S/A and the external controller consists of Baud Rate synchronization. The external controller can be set to any one of the following Baud Rates:



1 - 300	5 - 4800
2 - 600	6 - 9600
3 - 1200	7 - 19200
4 - 2400	

Use the following procedure to initialize the FM/AM-1200S/A for RS-232/GPIB operation:

STEP	PROCEDURE
------	-----------

1. Connect external controller to FM/AM-1200S/A at RS-232/GPIB Connector (43).
2. Check FM/AM-1200S/A Protocol (Appendix B).
3. Press   on the Keyboard (18), followed by the number corresponding to the desired Baud Rate as shown above.

Example: Set Baud Rate to 4800

Press   

"SET BAUD RATE 5" will be displayed on VFD (37).

4. Type two CR (carriage returns) on external controller. "RS-232 ENABLED" should be displayed on VFD (37).
5. If a computer is available, a program may be used for control. The following example will work on IBM-compatible types. Notice that Baud Rate is 9600 in the example.

```

10 OPEN "COM1:9600 ,N ,8 ,1 ,CS ,DS, LF" AS #1
20 PRINT #1, "2"+CHR$(13)
30 INPUT "CMD: ";CMD$
40 IF CMD$="QUIT" THEN 160
50 PRINT #1, CMD$
60 IF RIGHT$(CMD$,1)="?" THEN GOSUB 120
70 IF CMD$ = "MTR1" OR CMD$ = "MTR2" THEN GOSUB 120
80 IF CMD$ = "MDS" THEN GOSUB 120
90 IF CMD$ = "DVMAC" OR CMD$="DVMD" THEN GOSUB 120
100 IF CMD$ = "UOK" THEN GOSUB 120
110 GOTO 30
120 INPUT #1,RET$
130 PRINT RET$
140 IF RET$="**" GOTO 120
150 RETURN
160 END

```

4-11-2 RS-232 COMMAND PROCEDURE AND DATA STRUCTURE

All FM/AM-1200S/A functional commands and data information are transferred over the RS-232 as uppercase ASCII alphanumeric character strings designed to replace the front panel controls.

All input commands sent to the FM/AM-1200S/A are placed in an internal queue that will accommodate up to 128 bytes of data. Command strings may be packed together, but the individual commands must be separated by a colon ":" delimiter. The colon ":" may or may not cause the command to be executed immediately, depending upon the type of external controller being used. The following ASCII Characters will always terminate the command or series of commands:

ASCII Carriage Return (0D)	- CR
ASCII Line Feed (0A)	- LF

Maximum command string length including spaces and delimiters is 128 characters. If the command string exceeds 128 characters, everything up to the most recent delimiter will be accepted and the rest ignored. All spaces will be ignored except when using the "!" command.

Returned data to the external controller will not be packed together in a string. Instead, each set of data returned will be on an individual line and sent out in the order in which its command was sent. That is, the first "get" instruction sent in a command string will cause the returned data to be on the first line of the output; the second "get" instruction will cause the returned data to be on the second line of the output, and so on.

Data inputs that are out of specific range will generally default to the minimum values or initial condition values.

4-11-3 ALLOWABLE RS-232 COMMAND FORMATS

FM/AM-1200S/A communication with an external controlling device requires use of the allowable RS-232 command formats listed in Table 4-12.

COMMAND	DEFINITION	EXAMPLE
FUNC=VALUE (CR or Colon)*	Sets memory location 0 of selected function to value selected and executes it.	AFF=12345.6 Sets Tone Generator memory location 0 to 12345.6 Hz and executes it.
Func(nn)=VALUE*	Programs memory location (0 to 15) of selected function to value selected. Does not execute selection.	RFF6=345.6666 Programs RF Frequency memory location 6 to 345.6666 MHz.
FUNC (CR or Colon)*	Executes value of selected function stored in memory location 0.	DTMF: Executes value stored in DTMF memory location 0.
FUNC (nn) (CR or Colon)*	Executes value of selected memory location (0 to 15) of selected function.	PULSE 12: Executes value stored in memory location 12 of the PULSE function.
FUNC (nn)?*	Displays on VFD the value of selected memory location (0 thru 15) of the selected function.	RFF2? Displays value of RF memory location 2.
		AFF10? Displays value of Tone Generator memory location 10.

* FUNC = AFF, DPX, DCS, DTM, DTMF, MTR1, MTR2, PUL, PULS, PULSE, RFF or WAV.
 (nn) = function preset number (0 thru 15).
 Linefeed, Carriage Return or Colon = terminates command.
 Value = function command value field.

Table 4-12 Allowable Command Formats

4-11-4 RS-232 REMOTE COMMANDS

In the remote mode, remote commands override the FM/AM-1200S/A front panel controls and switches. RS-232 Remote Commands, listed in Table 4-13, must be preceded by the REM Command.

FUNCTION	RS-232 COMMAND	DESCRIPTION
RECEIVER	REM	Puts FM/AM-1200S/A in Remote Mode.
	REC	Puts FM/AM-1200S/A in Receive Mode.
	RFFn=x	Programs RF Frequency. n = 0 to 15 RF Memory Location. x = 000.0000 to 999.9999
	RFF=x	Programs and executes RF Frequency specified by Memory Location 0. x = 000.0000 to 999.9999
	RFFn?	Displays RF Frequency from Memory Location n on VFD. n = 0 to 15.
	RFFn	Executes RF Frequency specified by Memory Location n. n = 0 to 15
	RFEx	Sets FREQ ERROR Meter to RF range as specified by x. x = 1 to 6 1 = 30 Hz RF 2 = 100 Hz RF 3 = 300 Hz RF 4 = 1 kHz RF 5 = 3 kHz RF 6 = 10 kHz RF
	Rx	Sets Modulation Meter. (* indicates Full scale) x = 2, 6, 20, 60 2 = 2 kHz or 20% F.S.* 6 = 6 kHz or 60% F.S.* 20 = 20 kHz or 200% F.S.* 60 = 60 kHz or 600% F.S.*

Table 4-13 RS-232 Remote Commands

FUNCTION	RS-232 COMMAND	DESCRIPTION
RECEIVER (cont)	SIG	Sets Modulation Meter to measure relative signal strength (uncalibrated).
	15A	Sets the Modulation Meter to 15 Watt range to measure average power.
	15ØA	Sets the Modulation Meter to 150 Watt range to measure average power.
	15P	Sets the Modulation Meter to 15 Watt range to measure Peak power.
	15ØP	Sets the Modulation Meter to 150 Watt range to measure Peak power.
GENERATE	REM	Puts FM/AM-1200S/A in Remote mode.
	GEN	Puts FM/AM-1200S/A in Generate mode.
	RFFn=x	Programs RF Frequency. n = Ø to 15 RF Memory Location x = ØØØ.ØØØØ to 999.9999
	RFF=x	Programs and executes RF Frequency specified by Memory Location Ø. x = ØØØ.ØØØØ to 999.9999
	RFFn?	Displays RF Frequency from Memory Location n on VFD. n = Ø to 15
	RFFn	Executes RF Frequency specified by Memory Location n. n = Ø to 15
	AFFn=x	Programs Tone Generator Frequency. n = Memory Location Ø to 15 x = ØØØØØ.Ø to 99999.9
	AFF=x	Programs and executes Tone Generator Frequency specified by Memory Location Ø. x = ØØØØØ.Ø to 99999.9

Table 4-13 RS-232 Remote Commands (Continued)

FUNCTION	RS-232 COMMAND	DESCRIPTION
GENERATE (cont)	AFFn?	Displays Tone Generator Frequency from Memory Location n on VFD. n = 0 to 15
	AFFn	Executes Tone Generator Frequency specified by Memory Location n. n = 0 to 15
	WAVn=x	Programs the Tone Waveform. n = 0 to 15 x = SIN, SQU, RMP, TRI
	WAVn?	Displays Wave Shape from Tone Memory Location n on VFD. n = 0 to 15
DUPLEX	REM	Puts FM/AM-1200S/A in Remote mode.
	DUP	Puts FM/AM-1200S/A in Duplex mode.
	RFFn=x	Programs RF Frequency. n = 0 to 15 RF Memory Location x = 000.0000 to 999.9999
	RFF=x	Programs and executes RF Frequency specified by Memory Location 0. x = 000.0000 to 999.9999
	RFFn?	Displays RF Frequency from Memory Location n on VFD. n = 0 to 15
	RFFn	Executes RF Frequency specified by Memory Location n. n = 0 to 15
	DPXn=x	Programs Duplex Offset. n = 0 to 15 x = -49.99 to +49.99
	DPX=x	Programs and Executes Duplex Offset specified by Memory Location 0. x = -49.99 to +49.99

Table 4-13 RS-232 Remote Commands (Continued)

FUNCTION	RS-232 COMMAND	DESCRIPTION
DUPLEX (cont)	DPXn?	Displays Duplex Offset from Memory Location n on VFD. n = 0 to 15
	DPXn	Executes Duplex Offset specified by Memory Location n. n = 0 to 15
DUPLEX GENERATE	REM	Puts FM/AM-1200S/A in Remote mode.
	DPG	Puts FM/AM-1200S/A in Duplex Generate mode.
	RFFn=x	Programs RF Frequency. n = 0 to 15 x = 000.0000 to 999.9999
	RFF=x	Programs and executes RF Frequency specified by Memory Location 0. x = 000.0000 to 999.9999
	RFFn?	Displays RF Frequency from Memory Location n on VFD. n = 0 to 15
	RFFn	Executes RF Frequency specified by Memory Location n. n = 0 to 15
	DPXn=x	Programs Duplex Offset n = 0 to 15 x = -49.99 to +49.99
	DPX=x	Programs and executes Duplex Offset specified by Memory Location 0. x = 000.0000 to 999.9999
	DPXn?	Displays Duplex Offset from Memory Location n on VFD. n = 0 to 15
	DPXn	Executes Duplex Offset specified by Memory Location n. n = 0 to 15

Table 4-13 RS-232 Remote Commands (Continued)

FUNCTION	RS-232 COMMAND	DESCRIPTION
TONE FORMATS	REM	Sets FM/AM-1200S/A to Remote.
	DTMn=x or DTMFn=x	Programs DTMF Phone #. n = Memory Location 0 to 15 x = Up to 16 digits (0-9,A,B,C, D, #, or *)
	DTM=x or DTMF=x	Programs and executes DTMF Phone # specified by Memory Location 0. x = Up to 16 digits (0-9,A,B,C, D, #, or *)
	DTMn? or DTMFn?	Displays DTMF Phone # in Memory Location n on VFD. n = 0 to 15
	DTMn or DTMFn	Executes DTMF Phone # specified by Memory Location n. n = 0 to 15
	DTME	Sets FM/AM-1200S/A to DTMF Encode operation and returns DTMF value displayed on VFD after reception. (FM/AM-1200S/A must be set to Receive Mode and correct RF Frequency must be executed.)
	PULn=x or PULSn=x or PULSEn=x	Programs PULSE Phone #. n = 0 to 15 x = Up to 16 digits (0-9,A,B,C, D, #, or *)
	PUL=x or PULS=x or PULSEn=x	Programs and executes PULSE Phone # specified by Memory Location 0. x = Up to 16 digits (0-9,A,B,C,D, #, or *)
	PULn? or PULSn? or PULSEn?	Displays PULSE Phone # in Memory Location n on VFD. n = 0 to 15

Table 4-13 RS-232 Remote Commands (Continued)

FUNCTION	RS-232 COMMAND	DESCRIPTION
TONE FORMATS (cont)	PULn or PULSn or PULSEn	Executes PULSE Phone # specified by Memory Location n. n = 0 to 15
	DCS=x	Sets DCS to the Octal value specified by x. x = 0 ₈ TO 777 ₈
	DCS?	Displays the DCS value on VFD.
	DCS	Executes DCS value.
	VF1n	Executes Variable Frequency PULSE at 10 pulses per second. n = DTMF/PULSE Memory Location from 0 to 15.
		(Tone Generator Frequency Memory Location 0 must be programmed to desired frequency and waveform.)
	VF2n	Executes Variable Frequency PULSE at 20 pulses per second. n = DTMF/PULSE Memory Location from 0 to 15.
		(Tone Generator Frequency Memory Location 0 must be programmed to desired frequency and waveform.)
MEASUREMENT	REM	Sets FM/AM-1200S/A to Remote.
	MTR1?	Sets VFD display to meters and returns current value of FREQ ERROR as specified by range selected.
	RFEx	Sets FREQ ERROR Meter to RF range as specified by x. x = 1 to 6 1 = 30 Hz RF 2 = 100 Hz RF 3 = 300 Hz RF 4 = 1 kHz RF 5 = 3 kHz RF 6 = 10 kHz RF

Table 4-13 RS-232 Remote Commands (Continued)

FUNCTION	RS-232 COMMAND	DESCRIPTION
MEASUREMENT (cont)	AFEx	Sets the FREQ ERROR meter to audio range as specified below by x. x = 1 to 3 1 = 3 Hz 2 = 30 Hz 3 = 300 Hz
	MTR2?	Sets VFD display to meters and returns current value of modulation as specified by range and function selected.
	Rx	Sets Modulation Meter to kHz/%x10 range as specified by x. (* indicates Full Scale). x = 2, 6, 20, 60 2 = 2 kHz or 20% F.S.* 6 = 6 kHz or 60% F.S.* 20 = 20 kHz or 200% F.S.* 60 = 60 kHz or 600% F.S.*
	15A	Sets the Modulation Meter to 15 Watt range to measure average power.
	15ØA	Sets the Modulation Meter to 150 Watt range to measure average power.
	15P	Sets the Modulation Meter to 15 Watt range to measure Peak power.
	15ØP	Sets the Modulation Meter to 150 Watt range to measure Peak power.
	SIG	Sets Modulation Meter to measure relative signal strength (uncalibrated).
	DIS	Sets the Modulation Meter to measure distortion on 0% to 20% range.

Table 4-13 RS-232 Remote Commands (Continued)

FUNCTION	RS-232 COMMAND	DESCRIPTION
MEASUREMENT (cont)	SID	Sets the Modulation Meter to measure SINAD on 3 dB to 20 dB range.
	BAT	Sets the Modulation Meter to measure the internal battery voltage on 0 to 20 VDC range.
	MDS?	Gets Modulation control setting as shown below. 1 = AM NAR 2 = AM NORM 3 = SSB 4 = FM NAR 5 = FM MID 6 = FM WIDE
	AM1	Sets Modulation control to AM NAR.
	AM2	Sets Modulation control to AM NORM.
	SSB	Sets Modulation control to SSB.
	FM1	Sets Modulation control to FM NAR.
	FM2	Sets Modulation control to FM MID.
	FM3	Sets Modulation control to FM WIDE.
	DVMAC	Sets auto-ranging voltmeter to read AC volts.
DVMDC	Sets auto-ranging voltmeter to read DC volts.	
DVMRM?	Gets auto-ranging voltmeter reading. DVMAC or DVMDC must be executed prior to this command.	
DISPLAY MESSAGE ON VFD	!x	Will display up to 16 ASCII characters on VFD. x = Desired Message

Table 4-13 RS-232 Remote Commands (Continued)

FUNCTION	RS-232 COMMAND	DESCRIPTION
GO TO LOCAL	LOC	Sets operation to Local mode, returning switch control to the front panel.
IDENTIFY	UOK	Will return a percent sign (%) if on line.
REPLY IDENTIFY	RID=ON	Enables reply identify.
	RID=OFF	Disables reply identify.
	RID?	Returns the Reply Identifier setting, ON or OFF.
	VER?	Displays version number of FM/AM-1200S/A firmware.
	STAT?	Displays 0 or 1 to indicate command error. 0 = No Error 1 = System Error
	DEL=(decimal #)	Changes the colon (:) de-limiter to another character entered as the decimal equivalent of the ASCII character, range 1-127. Example: DEL = 44, changes the delimiter to comma C,1.
	DEL?	Displays the decimal value of the current delimiter.
SCAN	SCAN = (from) (delimiter) (to)	Sets SCAN start/stop using 0-15 RF Memory Locations.
	SCAN?	Displays current RF Memory Locations programmed for SCAN.
	SCAN	Executes SCAN function.
	RESUME=X.X	Sets resume time in seconds.
	RESUME?	Displays current resume time programmed.

Table 4-13 RS-232 Remote Commands (Continued)

FUNCTION	RS-232 COMMAND	DESCRIPTION
STEP	STEPR=X.XXXX MHz	Sets RF Step Increments.
	STEPR?	Displays current RF STEP setting.
	STEPT=X.X Hz	Sets Tone STEP Increment.
	STEPT?	Displays current Tone STEP setting.
	STEPR+	Increments RF by RF STEP setting.
	STEPR-	Decrements RF by RF STEP setting.
	STEPT+	Increments Tone by Tone STEP setting.
	STEPT-	Decrements Tone by Tone STEP setting.
SQUELCH	SQUELCH?	Returns 1 or 0, squelched (1) or unsquelched (0).

Table 4-13 RS-232 Remote Commands (Continued)

SECTION 5 - AVAILABLE OPTIONS

5-1 GENERAL

The .2 PPM Frequency Standard is standard equipment for the FM/AM-1200A S/N 1500 and on and for the FM/AM-1200S S/N 5412 and on.

5-2 .2 PPM FREQUENCY STANDARD - OPTION 01

In addition to the standard features of the FM/AM-1200S/A, several optional features are available. These include:

5-3 .05 PPM FREQUENCY STANDARD - OPTION 02

The .05 PPM Frequency Standard provides the most stable frequency standard available for the FM/AM-1200S/A.

NOTE

The .05 PPM oven oscillator is powered by the internal battery when the test set is switched to battery operation. The FM/AM-1200S/A will turn on and operate immediately in the battery mode but the oven oscillator will not be within specifications without a required 15-minute warm-up period (with the test set at room temperature). Since the operation period using battery power is limited to approximately 30 minutes, it is therefore recommended that the FM/AM-1200S/A be connected to an external AC or DC power source for the required 15-minute warm-up period.

5-4 BATTERY - OPTION 04

The Battery is standard equipment for the FM/AM-1200A S/N 1510 and on and for the FM/AM-1200S S/N 5562 and on.

5-5 GENERATE AMPLIFIER - OPTION 05

5-5-1 GENERAL

The Generate Amplifier is a 30 dB amplifier intended to increase the output level of a generated signal above the normal maximum level by the service monitor. It is not designed to receive any signal directly from a Unit Under Test (UUT); however, if properly installed, it can be used to transmit and receive signals "off the air", using the antenna.

CAUTION

DO NOT TRANSMIT FROM A UUT DIRECTLY INTO THE GENERATE AMPLIFIER, OR THROUGH AN EXTERNAL ATTENUATOR. DAMAGE TO THE GENERATE AMPLIFIER AND/OR THE SERVICE MONITOR WILL RESULT.

5-5-2 INSTALLATION

Insert the banana plug on the Generate Amplifier into the AUX PWR Jack on the Front Panel of the Service Monitor and connect the BNC connector to the T/R Jack (reference Figure 5-1).

For Direct Connection TO UUT:

Connect coax cable between the UUT Test Jack on the Generate Amplifier and the Microphone Jack or other audio input on the UUT.

For Radio Installation Checkout:

WARNING

THIS TEST MUST BE PERFORMED WITH THE SERVICE MONITOR AND UUT INSIDE A SHIELDED AREA TO PREVENT UNRESTRICTED RADIATION OF RF SIGNALS.

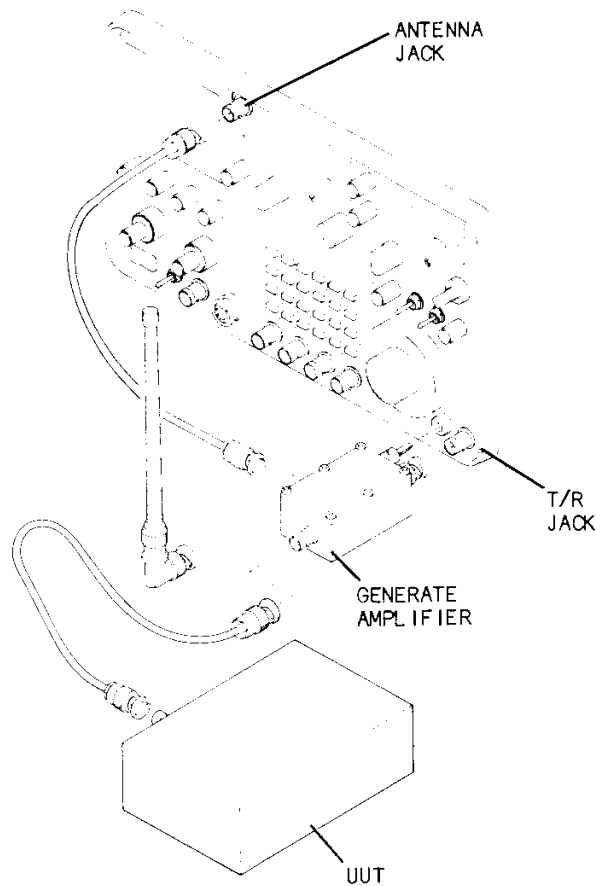

Figure 5-1 Generate Amplifier Installation

Connect coax between Antenna Jack on the Front Panel of the Service Monitor and the Antenna Jack on the Generate Amplifier. Connect accessory antenna to the UUT Test Jack on the Generate Amplifier.

5-5-3 OPERATION

Refer to Section 4 and perform the procedures for generating and receiving RF signals.

5-6 MICROPHONE - OPTION 06

This option provides a ceramic element microphone to use for voice modulation.

5-7 TELESCOPING ANTENNA - OPTION 07

This option provides a metal, telescoping antenna which will increase the distance at which a transmitted signal can be picked up at the antenna connector.

5-8 SOFT PADDED CARRYING CASE - OPTION 09

This option provides physical protection for the FM/AM-1200S/A if the need arises to transport the test set between job sites.

5-9 DIGITAL VOLTMETER AND DTMF DECODER — OPTION 10 (FM/AM1200A ONLY)

NOTE

The Digital Voltmeter is standard equipment for FM/AM-1200S units Serial Number 9267 and on.

5-9-1 GENERAL

The Digital Voltmeter and the DTMF Decoder are only functional if the optional DVM I/O PC Board (Option 10) is installed.

5-9-2 DIGITAL VOLTMETER OPERATION

FM/AM-1200S/A CONNECTORS AND INDICATORS APPLICABLE TO DIGITAL VOLTMETER OPERATION:

- 20 SCOPE/DVM Connector
- 37 VFD

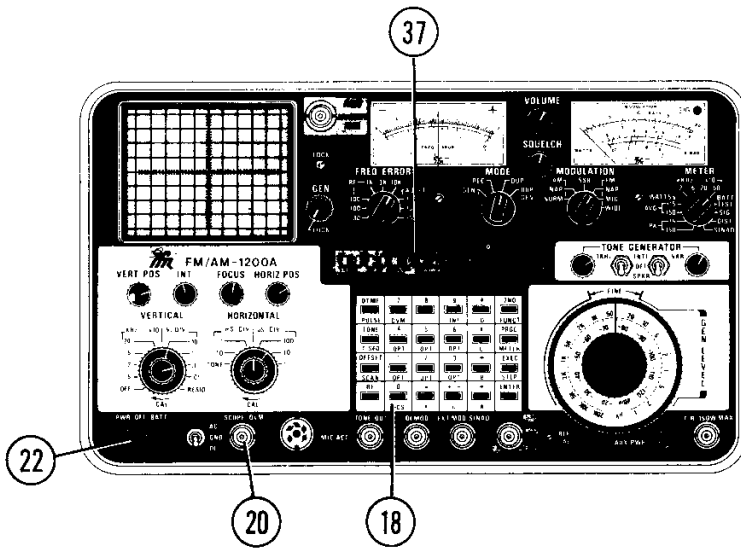

Figure 5-2 FM/AM-1200S/A Front Panel Controls Applicable to Digital Voltmeter Operation

CONTROL

- 18 Keyboard
- 22 PWR/OFF/BATT Switch

SETTING

As req'd
"PWR" or "BATT"



Table 5-2 FM/AM-1200S/A Front Panel Controls Applicable to Digital Voltmeter Operation

Table 5-1 lists the FM/AM-1200S/A front panel controls applicable to the Digital Voltmeter function. The Digital Voltmeter is capable of measuring AC or DC voltages up to a maximum of 100 volts. The VFD (37) displays the measured voltage. The scale displayed on the VFD (37) is auto-ranging, depending on the voltage input.

To use the digital voltmeter perform the following steps:
STEP PROCEDURE

CAUTION

DO NOT EXCEED 100 VDC OR 100 VRMS INPUT OR DAMAGE TO THE FM/AM-1200S/A MAY RESULT.

1. Connect unknown signal to SCOPE/DVM Connector (20).
2. Select digital voltmeter function by pressing:  
3. Select AC or DC mode by pressing:  for the desired display on the VFD (37).
4. Read voltage level of input signal on VFD (37).

NOTE

The input signal may also be displayed on the CRT Display (31) at the same time as a voltage reading is being taken. Refer to paragraph 4-8 for Oscilloscope Operation.

CAUTION

WHEN TAKING LOW VOLTAGE MEASUREMENTS (10 mV OR LESS) USING THE DVM, PLACE THE VERTICAL ATTENUATOR SELECTOR CONTROL (24) TO ANY "kHz/%X10" POSITION TO DISABLE.

5-9-3 DTMF DECODER OPERATION

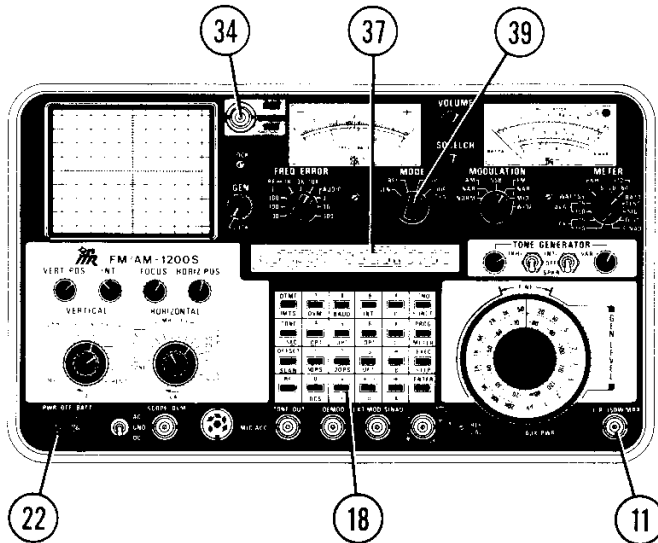

FM/AM-1200S/A CONNECTORS
AND INDICATORS APPLICABLE
TO DTMF DECODER OPERATION:

- 11 T/R Connector
- 34 ANT Connector
- 37 VFD

Figure 5-2 FM/AM-1200S/A Front Panel Controls
Applicable to DTMF Decoder Operation

CONTROL

SETTING

18	Keyboard	As req'd
22	PWR/OFF/BATT Switch	"PWR" of "BATT"
39	MODE Selector Control	"REC"

Table 5-2 FM/AM-1200S/A Front Panel Controls
Applicable to DTMF Decoder Operation

Table 5-2 lists the FM/AM-1200S/A front panel controls applicable to the DTMF Decoder function. The DTMF Decoder will decode up to sixteen digits and will display the digits on the VFD (37).

To use the DTMF Decoder, perform the following steps:

STEP	PROCEDURE
1.	Place the FM/AM-1200S/A front panel controls to the settings listed in Table 5-2.
2.	Using Keyboard (18), enter RF Frequency corresponding to frequency on which DTMF is to be transmitted.
3.	Connect an antenna or coax cable to the ANT Connector (34). If any transmitted signal is too strong for the ANT Connector power limitation (1/4 watt maximum), connect the coax cable to the T/R Connector (11).

STEP

PROCEDURE

4. Press:   on Keyboard (18).

5. Transmit DTMF tone sequence from source.

6. DTMF tone sequence (up to sixteen digits) will be decoded and displayed on the VFD (37).

7. If another DTMF tone sequence is to be decoded, again press:



5-10 EUROPEAN SIGNALING (ENCODE/DECODE) - OPTION 11

5-10-1 GENERAL

With the FM/AM-1200S/A European Signaling Option (Option 11) installed, the operator can select any of the following Sequential Tone Formats:

CCIR	ZVEI1	NATEL	2T
EEA	ZVEI2	EURO	
EIA	ZVEI3	5/6	

Once the desired tone format is selected, the user may edit, receive, or generate the tone sequence. This option automatically handles repeating digits so a repeat designator is not required for output.



5-10-2 FIVE DIGIT SIGNALING FORMAT OPERATION (INCLUDES CCIR, EEA, EIA, ZVEI1, ZVEI2, ZVEI3, NATEL AND EURO)

This option to the FM/AM-1200S/A allows the operator to check pager function using any of the above listed formats in either GENERATE or RECEIVE Mode. There is no direct mode with this option. The user may enter up to five digits when programming this format by utilizing the following procedure:

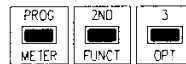

STEP PROCEDURE

1. Program the format by pressing:



2. Use the  and  cursor control keys to scroll through the

tone formats in the following sequence: CCIR, EEA, EIA, ZVEI1, ZVEI2, ZVEI3, NATEL, EURO, 5/6, 2T (Two Tone). Use the:

 and  cursor control keys to move the cursor desired position

and the  and  keys to increment and decrement the digits as

needed. Digits may be entered or edited regardless of the FM/AM-1200S/A GENERATE/RECEIVE Mode.

3. To execute the tone sequence (in either GENERATE or RECEIVE Mode), press:

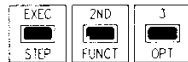

Paragraphs 5-10-3 thru 5-10-8 give examples of executing European Signaling formats.

SELECT:	CCIR	EEA	EIA	ZVEI1	ZVEI2	ZVEI3	NATEL	5/6	EURO
Tone #0	1981	1981	600	2400	2400	2200	1633	600	979.3
Tone #1	1124	1124	741	1060	1060	970	631	741	903.1
Tone #2	1197	1197	882	1160	1160	1069	697	882	832.5
Tone #3	1275	1275	1023	1270	1270	1160	770	1023	767.4
Tone #4	1358	1358	1164	1400	1400	1270	852	1164	707.4
Tone #5	1446	1446	1305	1530	1530	1400	941	1305	652.0
Tone #6	1540	1540	1446	1670	1670	1530	1040	1466	601.0
Tone #7	1640	1640	1587	1830	1830	1670	1209	1587	554.0
Tone #8	1747	1747	1728	2000	2000	1830	1336	1728	510.7
Tone #9	1860	1860	1869	2200	2200	2000	1477	1869	470.8
R Tone	2110	2110	459	2600	970	2400	1805	459	1062.9
Duration	100mS	40mS	33mS	70mS	70mS	70mS	70mS	33/ 52mS	33mS

Table 5-3 Toneset Frequency Table

5-10-3 PROGRAMMING AND EXECUTING ZVEI2 IN GENERATE MODE

To program and execute ZVEI2 in the GENERATE Mode, perform the following steps:



STEP PROCEDURE

1. Press:   

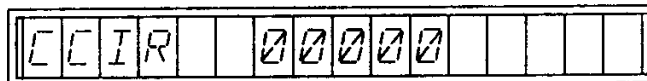





The VFD indicates:

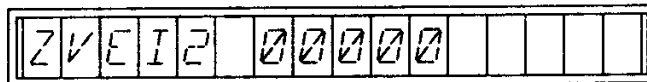

(or the last executed Encode/Decode function)

2. Press:  or  until the VFD indicates:





3. Press:       (or desired tone sequence).

The VFD indicates:



4. Press: 

The FM/AM-1200S/A is now programmed for ZVEI2 tone format with a tone sequence of 12345. To generate a tone sequence, ensure the FM/AM-1200S/A is in GENERATE Mode (ref paragraph 4-6).

5. Press:    to execute the tone sequence.

5-10-4 Executing Repeat Tones



Using the procedure in paragraph 5-10-3 will generate the programmed tone sequence once; it will not repeat itself. To restart the sequence, it must be executed again.



When repeating digits are found, however, the "R" (Repeat) tone is generated. For example, if:





is programmed, the FM/AM-1200S/A will generate "1R2R3".



Repeat tones may be entered and generated in either or two methods:

1. Press:   

2. Press  to move the cursor to the desired VFD digit and press  or  until the "R" character appears at that cursor location.

3. Alternatively, enter the "R" character by moving the cursor to the desired location in the tone sequence and pressing:  

The "R" character will appear in that cursor location.

4. Press    to execute the tone sequence. Where the "R" character appears, the repeat tone will be generated.

5-10-5 EXECUTING FIVE DIGIT FORMAT IN RECEIVE MODE

To receive a tone sequence, program the applicable tone format and perform the following steps:

STEP PROCEDURE

1. Turn MODE Select Control (39) to "REC".
2. Turn MODULATION Select Control (3) to "FM NAR".
3. Enter the applicable RF Frequency (ref. paragraph 4-2-1 and 4-3-1).
4. Press:



The VFD will display:

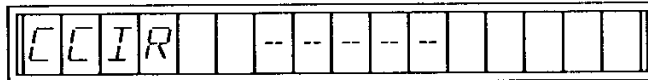

until a tone sequence is decoded. The decoded tone sequence will be displayed on the VFD until

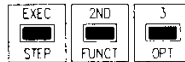

is pressed again.

NOTE

When decoding tone sequences, an "R" will only appear if the first tone received is the repeat tone:

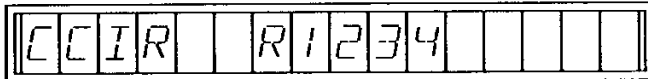

In all other sequences, the repeat tone will be automatically decoded as the preceding digit; e.g.:

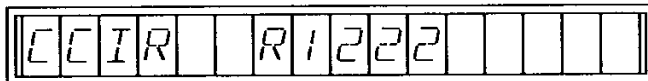

Compliance with the following will avoid confusion in the decoding process:

NOTE

1. Do not execute the receive option when there is activity on a receive channel.
2. When decoding sequential numbers or when a poor signaling environment is present, the code should be entered several times to eliminate the possibility of error.

5-10-6 EXECUTING NATEL IN RECEIVE MODE WITH RF SET TO 123.4567 MHz
 STEP PROCEDURE

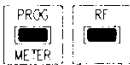
1. Press: 

The VFD indicates:

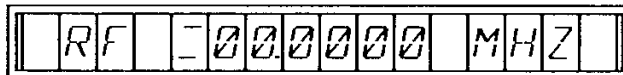

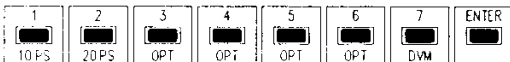
2. Press: 

The VFD indicates:

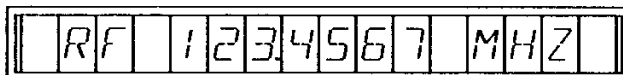



3. Press: 

The VFD indicates:

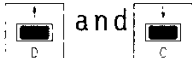

(Or other format, depending on last tone format programmed)

4. Press:  and  keys until the VFD indicates:

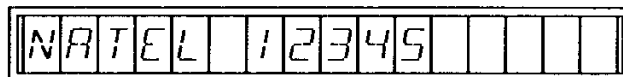

5. Press: 

The VFD indicates:

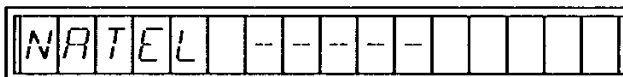

When a tone is received, the " - - - - " will be replaced with the decoded tone sequence.

6. Adjust squelch so frequency noise does not interfere with the decoding process.

NOTE

If an "E" appears on the VFD, the tone frequency for that digit is invalid or out of tolerance (± 50 Hz).

5-10-7 5/6 TONE SIGNALING FORMAT OPERATION

This format allows checking of pager function using a 5/6 tone encode/decode. This format will accept a preamble digit plus 5 or 6 trailing digits for signaling sequence. Program this tone format by the following steps:



STEP PROCEDURE

1. Press:   

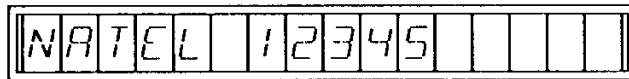





The VFD indicates:

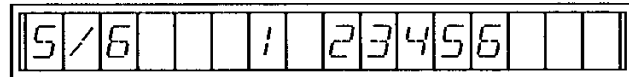

(Or other format, depending on last tone format programmed)

2. Press:  once, then  or  until the VFD indicates:



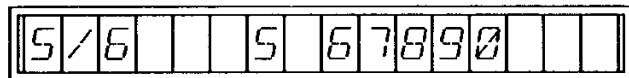

3. Press:       

The VFD indicates:



4. Press: 

5. To generate the tone sequence, press:   

6. Execute this tone format in Receive Mode as outlined in Paragraph 5-10-5.

5-10-8 TWO TONE SIGNALING FORMAT OPERATION

This format allows the setting of two tone frequencies, duration times for these frequencies and a GAP time between the generation of these two tones. The programming screen used to set these parameters is configured as:

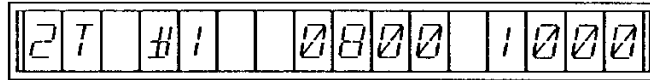

The segments of this programming screen and their ranges are:

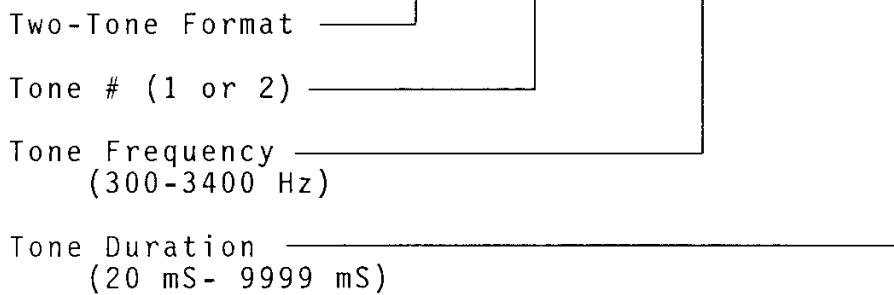

The and keys are used to move the cursor between the segments of the screen and the number keys or the and arrow keys are used to enter the required digits.

After the Tone #1 frequency and duration is entered, a screen will appear on the VFD which allows the entry of the GAP time, or interval between Tone #1 and Tone #2.

As an example, use the following steps to program a Two Tone format with an 800 Hz tone of 1 second duration for Tone #1, a 750 mS GAP time and a 600 Hz tone of 2 seconds duration for Tone #2:

STEP PROCEDURE

1. Press:

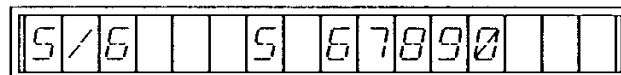

The VFD indicates:



(Or other format, depending on last tone format programmed)

STEP



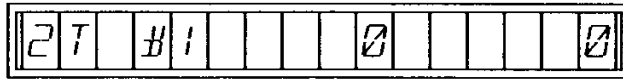

PROCEDURE

2. Press:  once, then  or  until the VFD indicates:





3. Press:       to move the cursor and enter the Tone #1 frequency. The VFD indicates:





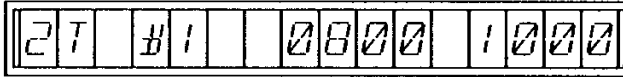

4. Press:     to enter the Tone #1 duration.

The VFD indicates:

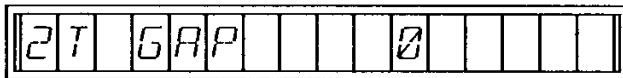



5. Press:  to place the Tone #1 information into the FM/AM-1200S/A memory. The VFD Display will switch to the GAP time programming screen:



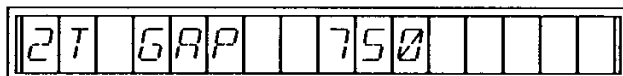

6. Press:     to enter the GAP (time delay) between Tone #1 and Tone #2.



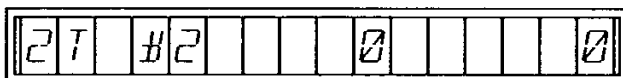

The VFD indicates:



7. Press:  to place the GAP information into the FM/AM-1200S/A memory. The VFD display will switch to the Tone #2 programming screen:



8. Press:  twice to move the cursor to the frequency field and

    to enter the Tone #2 frequency. The VFD indicates:

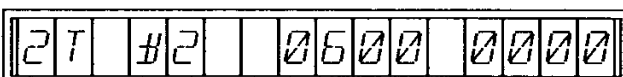

STEP PROCEDURE

9. Press:

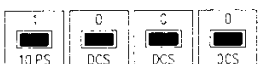

to enter the Tone #2 duration.

10. Press:



to enter the Tone #2 information into the FM/AM-1200S/A memory.

11. Press:

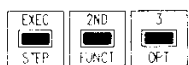

to execute the Two Tone sequence. To repeat the sequence, press:

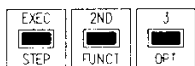

To execute the Two Tone sequence in the Receive Mode, reference the Notes in paragraph 5-10-5, then perform these steps:

STEP PROCEDURE

1. Set MODE Select Switch (39) to "REC".

2. Press:

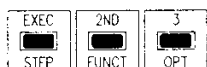

The VFD indicates:

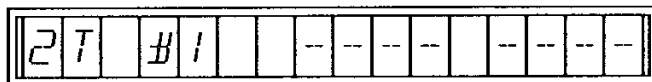

When a Two Tone Format signal is received, the "---- ----" will be replaced by the received Tone #1 Frequency and Duration.

3. Use the cursor control keys to access a read the GAP time and the frequency and duration of Tone #2.

5-10-9 ENHANCED EUROPEAN SIGNALING (ENCODE/DECODE) - OPTION 11 W/SOFTWARE VERSION 4.0-04 (OR HIGHER) INSTALLED

The FM/AM-1200S/A with Software version 4.0-04 (or higher) installed has two new signalling formats available:

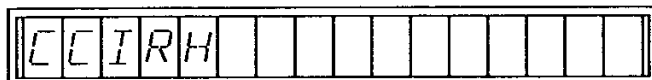

(20mS duration) and:

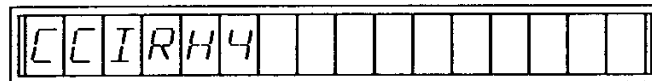

(40mS duration), plus a Deviation Set:

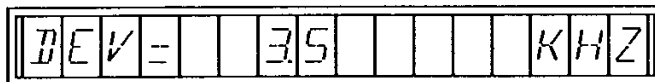

In addition to the two new formats, all encode/decode signalling formats have up to eight (8) digits available on the VFD screen for programming (although default programming will still only show five (5) digits.)

5-10-10 PROGRAMMING EIGHT DIGIT SIGNALING FORMAT OPERATION (INCLUDES CCIR, EEA, EIA, ZVEI1, ZVEI2, ZVEI3, NATEL, EURO CCIRH AND CCIRH4)

Program the formats in eight digits by the following steps:

STEP PROCEDURE

1. Press:

PROG METER	2ND FUNCT	3 OPT
---------------	--------------	----------

The following will appear on the VFD:



2. Press:

1 10PS	2 20PS	3 OPT	4 OPT	5 OPT	6 OPT	7 DVM	8 BAUD
-----------	-----------	----------	----------	----------	----------	----------	-----------

The VFD will show:

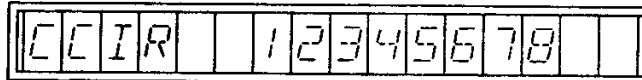

3. Press:

EXEC STEP	2ND FUNCT	3 OPT
--------------	--------------	----------

to execute the tone format.

5-10-11 ENHANCED 5/6 TONE FORMAT

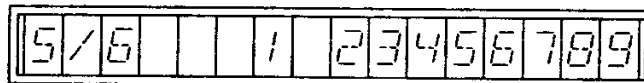

The enhanced 5/6 Tone signaling format will accept a preamble digit plus up-to eight trailing digits for signaling sequence; e.g.:





5-10-12 DEVIATION SET SELECT



The deviation set select allows the operator to program a deviation of up to 7.0 kHz by the following steps:

STEP _____ PROCEDURE _____

1. Press:   

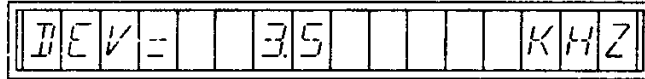
2. Use the  or  keys until the following appears on the VFD:





Deviations of up to 7.0 kHz may be set with the  or  keys or by entering the desired numbers using the Keyboard (18).

5-10-13 "G" CHARACTER ADDED TO PROGRAMMING

A "G" (for group) character is now available in programming in the enhanced ENCODE/DECODE. The operation of the FM/AM-1200S/A encode/decode with the "G" allows the operator to designate groups of three tones. Program the "G" character by the following steps:

STEP _____ PROCEDURE _____

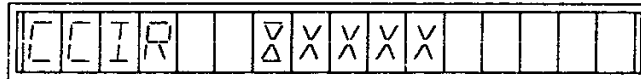

1. Press:   

2. Use the  or  keys until the following appears on the VFD:



NOTE

The cursor will appear, as shown, around the first character of the tone set.

3. Enter a "G" character by pressing:  

A letter "G" will appear and the cursor will move to the next tone character, e.g.:

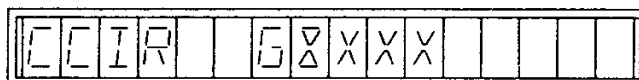

4. Additional tones may now be entered and output in the normal manner.

REMOTE COMMANDS	DESCRIPTION	RANGE OF VALUES
CCIR=	Set/Execute CCIR Encode	8 (Max) Euro-code digits
CCIR?	Return CCIR Decoded digits	8 (Max) Euro-code digits
CCIR	Execute CCIR Encode	
EEA=	Set/Execute EEA Encode	8 (Max) Euro-code digits
EEA?	Return EEA Decoded digits	8 (Max) Euro-code digits
EEA	Execute EEA Encode	
EIA=	Set/Execute EIA Encode	8 (Max) Euro-code digits
EIA?	Return EIA Decoded digits	8 (Max) Euro-code digits
EIA	Execute EIA Encode	
ZV1=	Set/Execute ZVEI1 Encode	8 (Max) Euro-code digits
ZV1?	Return ZVEI1 Decoded digits	8 (Max) Euro-code digits
ZV1	Execute ZVEI1 Encode	
ZV2=	Set/Execute ZVEI2 Encode	8 (Max) Euro-code digits
ZV2?	Return ZVEI2 Decoded digits	8 (Max) Euro-code digits
ZV2	Execute ZVEI2 Encode	
ZV3=	Set/Encode ZVEI3 Encode	8 (Max) Euro-code digits
ZV3?	Return ZVEI3 Decoded digits	8 (Max) Euro-code digits
ZV3	Execute ZVEI3 Encode	
NAT=	Set/Execute NATEL Encode	8 (Max) Euro-code digits
NAT?	Return NATEL Decoded digits	8 (Max) Euro-code digits
NAT	Execute NATEL Encode	
EUR=	Set/Execute EURO Encode	8 (Max) Euro-code digits
EUR?	Return EURO Decoded digits	8 (Max) Euro-code digits
EUR	Execute EURO Encode	
5/6=	Set/Execute 5/6 Encode	9 (Max) Euro-code digits
5/6?	Return 5/6 Decoded digits	9 (Max) Euro-code digits
5/6	Execute 5/6 Encode	
CCH=	Set/Execute CCIRH Encode	8 (Max) Euro-code digits
CCH?	Return CCIRH Decoded digits	8 (Max) Euro-code digits
CCH	Execute CCIRH Encode	

Table 5-3A European Encode/Decode GPIB/RS-232 Commands

REMOTE COMMANDS	DESCRIPTION	RANGE OF VALUES
CCH4=	Set/Execute CCIRH4 Encode	8 (Max) Euro-code digits
CCH4?	Return CCIRH4 Decoded digits	8 (Max) Euro-code digits
CCH4	Execute CCIRH4 Encode	
2T=	Set/Execute 2-Tone Encode	F1, D1, G, F2 or D2 [F1 = 0-9999 Hz (Freq #1) F2 = 0-9999 ms (Time #1) D1 = 0-9999 ms Gap) F2 = 0-9999 Hz (Freq #2) D2 = 0-9999 ms (Time #2)
2T?	Return 2-Tone Decoded digits	F1, D1, G, F2 or D2
2T	Execute 2-Tone Encode	
EDEV=	Set Encode Amplitude	0.00 - 9.99 kHz Dev.
EDEV?	Return programmed Encode Amplitude	0.00 - 9.99 kHz Dev.

Table 5-3A European Encode/Decode GPIB/RS-232 Commands

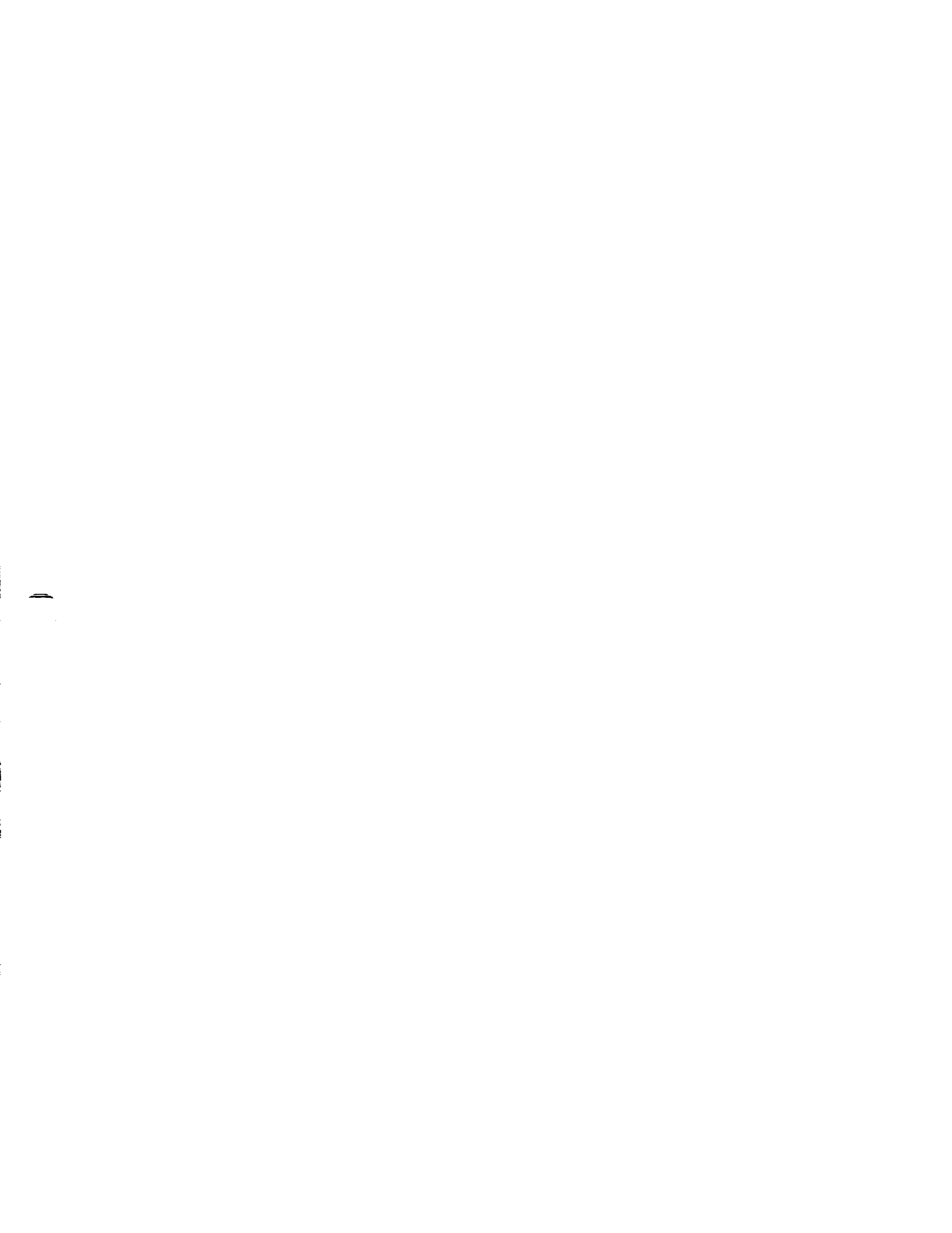

5-11 TRACKING GENERATOR - OPTION 12 (FM/AM-1200S ONLY)

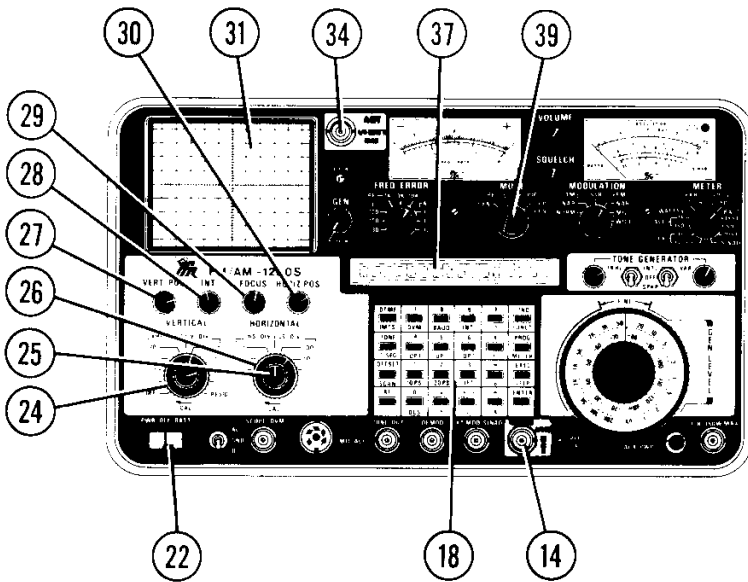

FM/AM-1200S CONNECTORS AND INDICATORS APPLICABLE TO TRACKING GENERATOR OPERATION:

- 14 DUPLEX Output Connector
- 31 CRT Display
- 34 ANT Connector
- 37 VFD

Figure 5-4 FM/AM-1200S Front Panel Controls Applicable to Tracking Generator Operation

18	Keyboard	"As req'd"
22	PWR/OFF/BATT Switch	"PWR" or "BATT"
24	VERTICAL ATTENUATOR Selector Control	Any position except "OFF"
25	HORIZONTAL Sweep Vernier Control	Fully cw
26	HORIZONTAL Sweep Selector Control	"1 MHz/Div"
27	VERT POS Control	"Mid Range"
28	INT Control	As req'd
29	FOCUS Control	As req'd
30	HORIZ POS Control	"Mid Range"
39	MODE Selector Control	DUP

Table 5-4 FM/AM-1200S Front Panel Controls Applicable to Tracking Generator

5-11-1 GENERAL

The Tracking Generator option allows operators to accomplish the tuning and alignment of radio communications components such as notch duplexers, circulators, combiners, isolators, etc. The device under test is connected between the swept RF output present at the DUPLEX Output Connector (14) and the input to the Spectrum Analyzer at the ANTENNA Connector (34).



5-11-2 SELECTING TRACKING GENERATOR MODE OF OPERATION

Table 5-4 lists the FM/AM-1200S front panel controls applicable to the Tracking Generator operation. To use the Tracking Generator, perform the following steps:

STEP	PROCEDURE
1.	Set the FM/AM-1200S front panel controls to the settings listed in Table 5-4.
2.	Connect the input of the unit under test to the DUPLEX Output Connector (14) of the FM/AM-1200S.
3.	Connect the output of the unit under test to the ANTENNA Connector (34) of the FM/AM-1200S.

CAUTION

MAXIMUM CONTINUOUS INPUT TO THE ANTENNA CONNECTOR (34) MUST NOT EXCEED 0.25 WATTS.

- Enter the center frequency of the UUT using the procedure outlined in paragraph 4-2-1.
- Press:  . One of the following displays will appear on the VFD:

DUPLEX HIGH



DUPLEX LOW

TRACK HIGH

TRACK MED

TRACK LOW

-  following one of these displays will indicate the currently selected mode of operation. Use the

 and  keys to scroll through the modes until the desired selection appears on the VFD.

NOTE

Output levels at the DUPLEX Output Connector (14) with the Tracking Generator installed are:

Track High: -3 dBm \pm 5 dB
 Track Med: -15 dBm \pm 7 dB
 Track Low: -40 dBm +5/-10 dB

7. Press  to select the desired output level.

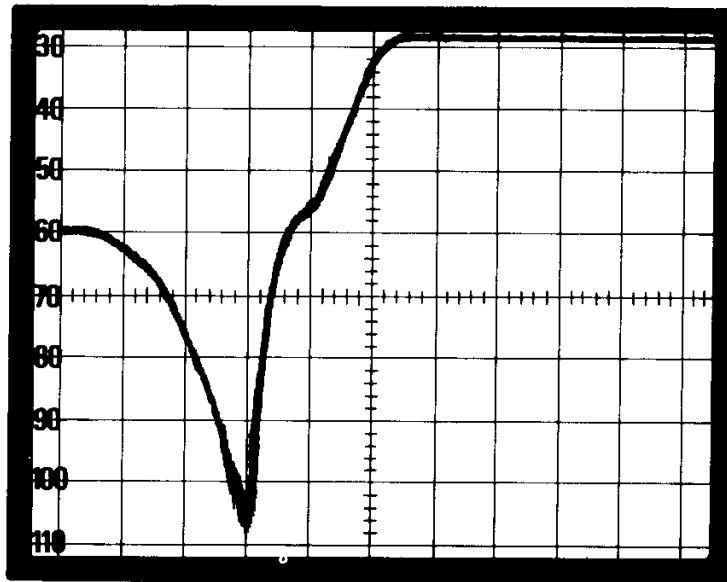

Figure 5-5 Typical Tracking Generator Display of a Notch Filter notch

HORIZONTAL/DISPERSION	BANDWIDTH	HORIZONTAL SWEEP SPEED*
1 kHz/DIV	300 Hz	10 mS/Div
2 kHz/DIV	300 Hz	10 mS/Div
5 kHz/DIV	3 kHz	5 mS/DIV
10 kHz/DIV	3 kHz	5 mS/DIV
20 kHz/DIV	30 kHz	5 mS/DIV
50 kHz/DIV	30 kHz	5 mS/DIV
.1 MHz/DIV	30 kHz	5 mS/DIV
.2 MHz/DIV	30 kHz	5 mS/DIV
.5 MHz/DIV	30 kHz	5 mS/DIV
1 MHz/DIV	30 kHz	5 mS/DIV

Table 5-5 Horizontal Sweep Selector Control (Analyzer Dispersion Control) Settings and Horizontal Sweep Speed

*All Sweep Speeds are variable by using the Horizontal Sweep Vernier Control (25).

5-11-3 TRACK ADJUST

While using the 3 kHz or 300 Hz resolution band, whenever dispersion, sweep speed or bandwidth is changed or when sweeping an external narrow band filter, the signal tracking may need to be adjusted.

Press the + or - key to set the FM/AM-1200S to the Track Adjust mode. The following display will appear on the VFD:

TRACK ADJ

This display will be followed by a number from

+50

to

-50

By continuing to press or hold the + or - key, the waveform trace on the Spectrum Analyzer screen may be adjusted to maximum amplitude. At the same time, the relative number following the words TRACK ADJ will increment or decrement accordingly. Continue to press or hold the + or - key until the trace reaches maximum amplitude.

Press  . This will set the TRACK ADJ relative number to "0". Any further adjustment to the trace using the TRACK ADJ mode will then be incremented from this "0" setting.

To leave the TRACK ADJ mode, simply press any other key on the Keyboard (18).

5-11-4 VARIABLE SWEEP SPEED

The horizontal sweep speed of the Tracking Generator may be varied to allow better resolution of frequency and amplitude components by use of the HORIZONTAL Sweep Vernier Control (25) in a manner similar to that used to vary the sweep speed of the Oscilloscope.

When the HORIZONTAL Sweep Vernier Control (25) is in the CAL position (fully cw), the horizontal sweep speed (see Table 5-5) is divided by a factor of one (1). As the control is turned ccw, the horizontal sweep is divided by a factor of from one (1) to ten (10).

5-11-5 RS-232 COMMANDS FOR TRACKING GENERATOR

RS-232 Command	Definition	Range of Values
DPL=	Set Duplex Level	HIGH, LOW (Tracking Generator disabled)
DPL?	Return Current Duplex Level	HIGH, LOW, OFF (OFF returned if Tracking Generator enabled)
TGL=	Set Tracking Generator Level	HIGH, MED, LOW (Duplex disabled)
TGL=	Return Current Tracking Generator Level	HIGH, MED, LOW, OFF (OFF Returned if Duplex enabled)
TGA=	Enable/Disable Tracking Generator Adjust. (Tracking Generator Level must be set.) Note: Tracking Generator Adjust must be disabled when adjustments are complete.	ON, OFF
TGA+	Tracking Generator Adjust Positive (Tracking Generator Adjust must be enabled)	
TGA-	Tracking Generator Adjust Negative (Tracking Generator Adjust must be enabled)	
TGR	Reset Tracking Generator Adjust Reference Number	

Table 5-6 Tracking Generator RS-232 Commands

5-12 GPIB OPERATION - OPTION 13

5-12-1 GENERAL

This section contains basic instructions for operating the FM/AM-1200S/A with the optional General Purpose Interface Buss (GPIB) compatible external device. Using these instructions, the operator can select any available parameter of the following FM/AM-1200S/A functions:



DTMF	OFFSET	IMTS (PULSE)	METER	
TONE	RF	TONE WAVEFORM	DCS	MODULATION

5-12-2 PREPARATION FOR USING GPIB

When the GPIB option is installed, a 24-pin GPIB connector is provided on the rear panel in place of the standard RS-232 connector. Pinouts for the GPIB connector are shown in Appendix B, Table B-4. The operator should insure proper interface between the FM/AM-1200S/A and the external controller. Once the proper connection is made, the FM/AM-1200S/A can be initialized with the proper address by using the GPIB Menu.

5-12-3 FM/AM-1200S/A INITIALIZATION

Use the following procedure to initialize the FM/AM-1200S/A for GPIB operation:

STEP	PROCEDURE
1.	Connect the external controller to the FM/AM-1200S/A at the GPIB Connector.
2.	Press:   on the Keyboard (18).
3.	Using the scroll keys and numbers, select: 9600 BAUD RATE (Selection 6) NO PARITY (0 = NONE, 1 = ODD, 2 = EVEN) 8 DATA Bits (7 or 8) 1 STOP Bit (1 or 2) GPIB ADDRESS (00 thru 31)

5-12-4 REMOTE CONTROL (GPIB) OPERATION

Remote communication with the FM/AM-1200S/A is provided by use of the GPIB, which conforms to the latest IEEE Standard 488-1978. The FM/AM-1200S/A has the following capabilities using ASCII encoded character strings:

Complete Source and Acceptor Handshake

Talker

Listener

Remote/Local (No local lockout capability)

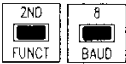
The GPIB Address is set through the  selection.

All communication with the FM/AM-1200S/A over the GPIB is implemented with ASCII-encoded character strings. Invalid or improperly formatted characters are discarded and two asterisks (**) will be returned to the controller. The ASCII String Commands are stored in a Buffer until receipt of a Carriage Return, Line Feed, Null Character or "END" message.

MNEMONIC MESSAGE	ASCII CODE (HEX)	IEEE 488 INSTRUCTION
ATN	bus signal line	ATTENTION
DAB	00-7F	Data Byte
DAC	bus signal line	Data Accepted
DAV	bus signal line	Data Valid
END	bus signal line	End
IDY	bus signal line	Identify
MLA	20-3F	My Listen Address
MTA	40-5F	My Talk Address
RFD	bus signal line	Read For Data
UNL	3F	Unlisten
UNT	5F	Untalk

Refer to the IEEE Standard 488-1978 for further explanation.
Table 5-7 IEEE 488-1978 BUS Messages

5-12-5 FM/AM-1200S/A AND GPIB MESSAGE INTERFACE DEFINITIONS

MESSAGE	DEFINITION
ATN	The FM/AM-1200S/A GPIB I/O device responds immediately to process the incoming GPIB controller commands.
DAB	The FM/AM-1200S/A GPIB microprocessor responds by status testing of the GPIB I/O device to accept data byte.
DAC	The FM/AM-1200S/A GPIB I/O device responds immediately to signal the talker it has accepted the data byte.
DAV	The FM/AM-1200S/A responds immediately to signal the interceptor it has put valid data on the BUS.
END	The FM/AM-1200S/A responds to terminate the command input from the source and to begin processing the commands available up to the last valid delimiter.
IDY	Same as "END".
MLA	The FM/AM-1200S/A GPIB I/O device responds immediately by comparing its address with the listen address given. If the two are the same, it instructs the processor to listen.
MTA	The FM/AM-1200S/A GPIB I/O device compares its address with the talk address given. If the two are the same, it instructs the processor to talk.
RFD	The FM/AM-1200S/A GPIB I/O device signals the source it is ready for data to be transmitted on the bus.
UNL	The FM/AM-1200S/A GPIB I/O device and the processor respond to unlisten the test set.
UNT	The FM/AM-1200S/A GPIB I/O device and the processor respond to untalk the test set.

Table 5-8 GPIB Message Definitions

5-12-6 GPIB TRANSACTIONS

Two examples of GPIB transactions showing the ASCII Character String to be transmitted followed by the necessary BUS operations to complete the transactions are shown below. These examples were generated and executed using a GPIB controller that uses an ANSI Standard Basic Interpreter with enhancements allowing direct communication over GPIB using special GPIB interface hardware. In the examples, the ASCII Character String to be transmitted is shown first, followed by the bus operations required to complete the transaction.

A. Example No. 1 - Instruct the FM/AM-1200S/A to set the RF to 500 MHz.

1. ASCII String: "RFF = 500" (Followed by carriage return and line feed.)
2. BUS Transaction: UNT, UNL, MTA, DAB "R", DAB "=", DAB "5", DAB "0", DAB "0", DAB CR, DAB LF.

B. Example No. 2 - Instruct the FM/AM-1200S/A to return the RF Attenuation.

1. ASCII String: "RFF?"
2. BUS Transaction:
 - a. Output Cycle - UNT, UNL, MLA, MTA, DAB "R", DAB "F", DAB "?", DAB CR, DAB LF.
 - b. Input Cycle - UNT, UNL, MLA, MTA, DAB "1", DAB "0", DAB CR, DAB LF.

The Input Cycle shows the RF Attenuation to be -10 dB.

5-12-7 ASCII OUTPUT COMMANDS TO THE FM/-1200S/A

All input commands sent to the FM/AM-1200S/A are placed in an internal queue that will accommodate up to 128 bytes of data. Command Strings may be packed together, but the individual commands must be separated by delimiters. The delimiters are:

ASCII COLON ":"

ASCII PERIOD "."

ASCII QUESTION MARK "?"

NOTE

The Question Mark ("?") will be accepted at any time and ignored unless it follows a command. This allows the user to continually interrogate the output buffer when waiting for a measurement.

The Colon (":") is a general delimiter and may be used after the Period or Question Mark. Care must be exercised in using the Period or Question Mark at the end of a command as they may change the interpretation of that command.

The following ASCII Characters will terminate the output command or series of commands:

ASCII Carriage Return (0D) - CR

ASCII Line Feed (0A) - LF

NULL Character (0) - NL

When the FM/AM-1200S/A is the assigned talker, the EOI line will be set when a line feed (0A) is sent.

NOTE

The user's GPIB controller must be programmed to expect an ASCII line feed (0A) character as the input string termination.

5-12-8 ASCII OUTPUT COMMAND DATA FORMAT

All spaces will be ignored. Below are some examples of commands which are valid.

RFF = 100: RFF?

RFF1 = 10:

The above commands set the Reply Identifier Flag which caused the command label following "RID=ON" to be attached to the response.

5-12-9 RETURN DATA FORMAT

The returned data format convention is similar to the Output Command Data Format in that all returns will be packed together and separated by ASCII Colon (":") delimiters. The number of responses returned is determined by the number of commands transferred in one block. If the number of responses required causes the internal response buffer to overflow by being larger than 128 bytes, only the responses up to the most recent delimiter will be returned.

Data inputs that are out of specific range will generally default to the minimum values or initial condition values.

5-12-10 REPLY IDENTIFIER

When the Reply Identifier is activated by the command "RID=ON", the returned information for data or status requests will be preceded by the command mnemonic and an "=" character. This will continue until the command "RID=OFF" is given or the FM/AM-1200S/A power is cycled. This feature is especially useful for identifying measured data that is returned after a time delay, or data returned from a string of commands.

5-12-11 ALLOWABLE GPIB COMMAND FORMATS

The following list defines the Commands used to control the FM/AM-1200S/A under GPIB operation. Qualifiers for each command are used throughout the following paragraphs and are defined as follows:

- An "=" represents a "set" operation for that command.
- A "?" represents a "get" operation for that command.
- A "." represents an "enable" operation for that command.

Data listed under the range column reflects input/output data of the FM/AM-1200S/A. Data shown in parentheses is input data. Data not enclosed in parentheses is output data. A dash is used for commands having no input/output data.

FM/AM-1200S/A communication with an external controlling device requires use of the allowable GPIB command formats listed in Table 5-7.

COMMAND	DEFINITION	EXAMPLE
FUNC=VALUE (CR or Colon)	Sets memory location 0 of selected function to value selected and executes it.	AFF=12345.6 Sets Tone Generator memory location 0 to 12345.6 Hz and executes it.
Func (nn)=Value*	Programs memory location (0 to 15) of selected function to value selected. Does not execute function.	RFF6=345.666 Programs RF Frequency memory location 6 to 345.6666 MHz.
FUNC (CR or Colon)	Executes value of selected function stored in memory location 0.	DTMF: Executes value stored in DTMF memory location 0.
Func (nn) (CR or Colon)	Executes value of selected memory location (0 to 15) of selected function.	PULSE 12: Executes value stored in memory location 12 of the PULSE function.
FUNC (nn)?*	Displays on VFD the value of selected memory location (0 thru 15) of the selected function.	RFF2? Displays value of RF memory location 2. AFF10? Displays value of Tone Generator memory location 10.

* FUNC = AFF, DPX, DCS, DTM, DTMF, MTR1, MTR2, PUL, PULS, PULSE, RFF or WAV.
 (nn) = function preset number (0 thru 15).
 Linefeed, Carriage Return or Colon = terminates command.
 Value = function command value field.

Table 5-9 GPIB Command Format

5-12-12 GPIB REMOTE COMMANDS

In the remote, remote commands override the FM/AM-1200S/A front panel controls and switches. GPIB Remote Commands must be preceded by the REM Command.

FUNCTION	GPIB COMMAND	DESCRIPTION
RECEIVER	REM	Puts FM/AM-1200S/A in Remote Mode.
	REC	Puts FM/AM-1200S/A in Receive Mode.
	RFFn=x	Programs RF Frequency. n = 0 to 15 RF Memory Location. x = 000.0000 to 999.9999
	RFF=x	Programs and executes RF Frequency specified by Memory Location 0. x = 000.0000 to 999.9999
	RFFn	Executes RF Frequency specified by Memory Location n. n = 0 to 15
	RFE _x	Sets FREQ ERROR Meter to RF range as specified by x. x = 1 to 6 1 = 30 Hz RF 2 = 100 Hz RF 3 = 300 Hz RF 4 = 1 kHz RF 5 = 3 kHz RF 6 = 10 kHz RF
	R _x	Sets MODULATION Meter to kHz/%x10 range as specified by x. x = 2, 6, 20, 60 2 = 2 kHz or 20% Full Scale 6 = 6 kHz or 60% Full Scale 20 = 20 kHz or 200% Full Scale 60 = 60 kHz or 600% Full Scale
	SIG	Sets MODULATION Meter to measure relative signal strength (uncalibrated).

Table 5-10 GPIB Commands

FUNCTION	GPIB COMMAND	DESCRIPTION
RECEIVER (Cont)	15A	Sets the MODULATION Meter to 15 Watt range to measure average power.
	150A	Sets the MODULATION Meter to 150 Watt range to measure average power.
	15P	Sets the MODULATION Meter to 15 Watt range to measure Peak power.
	150P	Sets the MODULATION Meter to 150 Watt range to measure peak power.
GENERATE	REM	Puts the FM/AM-1200S/A in Remote mode.
	GEN	Puts the FM/AM-1200S/A in Generate mode.
	RFFn=x	Programs RF Frequency. n = 0 to 15 RF Memory Location. x = 000.0000 to 999.9999
	RFF=x	Programs and executes RF Frequency specified by Memory Location 0. x = 000.0000 to 999.9999
	RFFn?	Displays RF Frequency from Memory location n on VFD. n = 0 to 15
	RFFn	Executes RF Frequency specified by Memory Location n. n = 0 to 15
	AFFn=x	Programs Tone Generator Frequency. n = 0 to 15 x = 00000.0 to 99999.9
	AFF=x	Programs and executes Tone Generator Frequency specified by Memory Location 0. x = 00000.0 to 99999.9

Table 5-10 GPIB Commands (Continued)

FUNCTION	GPIB COMMAND	DESCRIPTION
GENERATE (Cont)	AFFn?	Displays Tone Generator Frequency from Memory Location n on VFD. n = 0 to 15
	AFFn	Executes Tone Generator Frequency specified by Memory Location n. n = 0 to 15
DUPLEX	REM	Puts the FM/AM-1200S/A in Remote mode.
	DUP	Puts FM/AM-1200S/A in Duplex Mode.
	RFFn=x	Programs RF Frequency. n = 0 to 15 RF Memory Location. x = 000.0000 to 999.9999
	RFF=x	Programs and executes RF Frequency specified by Memory Location 0. x = 000.0000 to 999.9999
	RFFn?	Displays RF Frequency from Memory location n on VFD. n = 0 to 15
	RFFn	Executes RF Frequency specified by Memory Location n. n = 0 to 15
	DPXn=x	Programs Duplex Offset. n = 0 to 15 x = -49.99 to +49.99
	DPX=x	Programs and Executes Duplex Offset specified by Memory Location 0. x = -49.99 to +49.99
	DPXn?	Displays Duplex Offset from Memory Location n on VFD. n = 0 to 15
	DPXn	Executes Duplex Offset specified by Memory Location n. n = 0 to 15

Table 5-10 GPIB Commands (Continued)

FUNCTION	GPIB COMMAND	DESCRIPTION
DUPLEX GENERATE	REM	Puts the FM/AM-1200S/A in Remote mode.
	DPG	Puts FM/AM-1200S/A in Duplex Generate Mode.
	RFFn=x	Programs RF Frequency. n = 0 to 15 RF Memory Location. x = 000.0000 to 999.9999
	RFF=x	Programs and executes RF Frequency specified by Memory Location 0. x = 000.0000 to 999.9999
	RFFn?	Displays RF Frequency from Memory location n on VFD. n = 0 to 15
	RFFn	Executes RF Frequency specified by Memory Location n. n = 0 to 15
	DPXn=x	Programs Duplex Offset. n = 0 to 15 x = -49.99 to +49.99
	DPX=x	Programs and Executes Duplex Offset specified by Memory Location 0. x = -49.99 to +49.99
	DPXn?	Displays Duplex Offset from Memory Location n on VFD. n = 0 to 15
	DPXn	Executes Duplex Offset specified by Memory Location n. n = 0 to 15
TONE FORMATS	REM	Puts the FM/AM-1200S/A in Remote mode.
	DTMn=x or DTMF=x	Programs DTMF Phone # n = 0 to 15 x = Up to 16 digits (0-9, A,B,C,

Table 5-10 GPIB Commands (Continued)

FUNCTION	GPIB COMMAND	DESCRIPTION
TONE FORMATS (cont)	DTM=x or DTMF=x	Programs and executes DTMF Phone # specified by Memory Location 0. x = Up to 16 digits (0-9, A,B,C, D, # or *)
	DTMn? or DTMFn?	Displays DTMF Phone # in Memory Location n on VFD. n = 0 to 15
	DTMn or DTMFn	Executes DTMF Phone # specified by Memory Location n. n = 0 to 15
	DTME	Sets FM/AM-1200S/A to DTMF Encode operation and returns DTMF value displayed on VFD after reception. (FM/AM-1200S/A must be set to Receive Mode and correct RF Frequency must be executed.)
	PULn=x or PULS=x or PULSE=x	Programs IMTS (PULSE) Phone #. n = 0 to 15 x = Up to 16 digits (0-9, A, B, C, D, # or *)
	PUL=x or PULS=x or PULSE=x	Programs and executes IMTS (PULSE) Phone # specified by Memory Location 0. x = Up to 16 digits (0-9, A, B, C, D, # or *)
	PULn? or PULSn? or PULSEn?	Displays IMTS (PULSE) Phone # in Memory Location n on VFD. n = 0 to 15
	PULn or PULSn or PULSEn	Executes IMTS (PULSE) Phone # specified by Memory Location n. n = 0 to 15

Table 5-10 GPIB Commands (Continued)

FUNCTION	GPIB COMMAND	DESCRIPTION
TONE FORMATS (Cont)	DCS=x	Sets DCS to the Octal value specified by x. x = 0 ₈ to 777 ₈
	DCS?	Displays the DCS value on VFD.
	DCS	Executes DCS value.
	VF1n	Executes Variable Frequency IMTS (PULSE) at 10 pulses per second. n = DTMF/IMTS (PULSE) Memory Location from 0 to 15 (Tone Generator Frequency Memory Location 0 must be programmed to desired frequency and waveform.)
	VF2n	Executes Variable Frequency IMTS (PULSE) at 20 pulses per second. n = DTMF/IMTS (PULSE) Memory Location from 0 to 15 (Tone Generator Frequency Memory Location 0 must be programmed to desired frequency and waveform.)
MEASUREMENT	REM	Puts the FM/AM-1200S/A in Remote mode.
	MTR1	Sets VFD display to meters and returns current value of FREQ ERROR as specified by range selected.
	RFEx	Sets FREQ ERROR Meter to RF range as specified by x. x = 1 to 6 1 = 30 Hz RF 2 = 100 Hz RF 3 = 300 Hz RF 4 = 1 kHz RF 5 = 3 kHz RF 6 = 10 kHz RF

Table 5-10 GPIB Commands (Continued)

FUNCTION	GPIB COMMAND	DESCRIPTION
MEASUREMENT (Cont)	AFEx	Sets FREQ ERROR Meter to Audio range as specified by x. x = 1 to 3 1 = 3 Hz 2 = 30 Hz 3 = 300 Hz
	MTR2	Sets VFD display to meters and returns current value of MODULATION as specified by range selected.
	Rx	Sets MODULATION Meter to kHz/%x10 range as specified by x. x = 2, 6, 20, 60 2 = 2 kHz or 20% Full Scale 6 = 6 kHz or 60% Full Scale 20 = 20 kHz or 200% Full Scale 60 = 60 kHz or 600% Full Scale
	15A	Sets the MODULATION Meter to 15 Watt range to measure average power.
	150A	Sets the MODULATION Meter to 150 Watt range to measure average power.
	15P	Sets the MODULATION Meter to 15 Watt range to measure Peak power.
	150P	Sets the MODULATION Meter to 150 Watt range to measure peak power.
	SIG	Sets MODULATION Meter to measure relative signal strength (uncalibrated).
	DIS	Sets the MODULATION Meter to measure Distortion on 0% to 20% range.
	SID	Sets the MODULATION Meter to measure SINAD on 3 dB to 20 dB range.

Table 5-10 GPIB Commands (Continued)

FUNCTION	GPIB COMMAND	DESCRIPTION
MEASUREMENT (Cont)	BAT	Sets the MODULATION Meter to measure the internal battery voltage on 0 to 20 VDC range.
	MDS	Sets MODULATION control settings as shown: 1 = AM NAR 2 = AM NORM 3 = SSB 4 = FM NAR 5 = FM MID 6 = FM WIDE
	AM1	Sets MODULATION control to AM NAR.
	AM2	Sets MODULATION control to AM NORM.
	SSB	Sets MODULATION control to SSB.
	FM1	Sets MODULATION control to FM NAR.
	FM2	Sets MODULATION control to FM MID.
	FM3	Sets MODULATION control to FM WIDE.
	DVMAC	Sets auto-ranging voltmeter to read volts AC.
	DVMDC	Sets auto-ranging voltmeter to read volts DC.
	DVMRM	Gets auto-ranging voltmeter reading. DVMAC or DVMDC must be executed prior to this command.
DISPLAY MESSAGE ON VFD	!x	Will display up to 16 ASCII characters on VFD. x = Desire Message
GO TO LOCAL	LOC	Sets operation to Local Mode, returning switch control to the front panel.
IDENTIFY	UOK	Will return a percent sign (%) if on line.

Table 5-10 GPIB Commands (Continued)

FUNCTION	GPIB COMMAND	DESCRIPTION
REPLY IDENTIFY	RID = ON	Enables Reply Identify
	RID = OFF	Disables Reply Identify
	RID?	Returns the Reply Identifier setting, ON or OFF
	VER	Displays version number of FM/AM-1200S/A firmware.
	STAT	Displays 0 or 1 to indicate command error. 0 = No Error 1 = System Error
	DEL=(decimal #)	Changes the colon (:) delimiter to another character entered as the decimal equivalent of the ASCII character, range 1-127. Example: DEL=44 change delimiter to comma (,)
	DEL?	Displays the decimal value of the delimiter character.
SCAN	SCAN = (from) (delimiter) (to)	Sets SCAN start/stop using 0-15 RF Memory Locations.
	SCAN?	Displays current RF Memory Locations programmed for SCAN.
	SCAN	Executes SCAN Function.
	RESUME = X.X	Sets resume time in seconds.

Table 5-10 GPIB Commands (Continued)

FUNCTION	GPIB COMMAND	DESCRIPTION
STEP	STEPR = X.XXX MHz	Sets RF Step Increments.
	STEPR?	Displays current RF STEP setting.
	STEPT = X.X Hz	Sets Tone STEP Increment.
	STEPT?	Displays current Tone STEP setting.
	STEPR+	Increments RF by RF STEP setting.
	STEPR-	Decrements RF by RF STEP setting.
	STEPT+	Increments Tone by Tone STEP setting.
	STEPT-	Decrements Tone by Tone STEP setting.
SQUELCH	SQUELCH?	Returns 1 for 0, squelched (1) or unsquelched (0).

Table 5-10 GPIB Commands (Continued)

5-13 TRUNKING – OPTION 14 (FM/AM-1200S ONLY)

5-13-1 GENERAL

The Trunking Option allows operators to test mobile communications radios and repeaters using the Johnson Trunked Radio operating system. The software-controlled test functions utilize the FM/AM-1200S T/R Connector (11), Duplex Output Connector (14) and ANT Connector (34) to test the Encode/Decode, Repeater Access and Handoff functions of Trunking Radio mobile units and the Handshake and Handoff functions of repeaters.

5-13-2 Trunking Operational Theory

Trunking is the sharing of all available channels in a repeater system by remote or mobile units with access to that repeater. A trunking system is composed of up to 20 repeaters, with each repeater assigned up to 250 separate ID codes. Trunking is based on the theory that an individual mobile unit, with access to several communication channels at once, has a low probability of being blocked from transmitting since the other subscribers to the system will use it only a small percentage of the time and that a large number of other subscribers will not use it at exactly the same instant. Hence, at least one channel will be free at any given time.

Each mobile unit in a trunking system is assigned a "Home Repeater" from which it receives digital control information. A listening mobile unit monitors data from its home repeater to determine on which channel it is being called by another mobile unit or which channel it may use if it wants to transmit.

Trunking systems are allocated 999 channel pairs in two separate bands by the FCC. In the lower band of 600 channel pairs, 806 MHz to 821 MHz is used for mobile transmit and 851 MHz to 866 MHz is used for mobile receive, with a 45 MHz offset between the transmit and receive frequency in each channel pair. In the upper band of 399 channel pairs, 896 MHz to 901 MHz is used for mobile transmit and 935 MHz to 940 MHz is used for mobile receive with a 39 MHz offset maintained between transmit and receive in each channel pair.

Each repeater in a trunking system uses only one channel pair to communicate with each of the mobile units assigned to it. If a mobile unit is instructed to use a different repeater, another channel pair is used.

Home repeaters can only exchange data with mobile units that have ID numbers assigned to that repeater. Other mobile units are ignored by a repeater unless the mobile unit has received permissions from a separate repeater to access the first repeater. This is known as a "Handoff". All repeaters in a trunking system are physically connected by coax so all repeaters in the community can be informed of accesses and handoffs.

Mobile units in the trunking system work in a simplex or push-to-talk manner. Some radios automatically handle push-to-talk and receive functions in a manner that makes them appear to be duplex in nature, yet these units are only half duplex. Mobile units can only hear messages transmitted through a repeater from mobiles in the ID number group assigned to that repeater. Likewise, mobile units can only transmit to other mobiles in the ID number group assigned to the same home repeater. Through a logic lock-out in the units, only one mobile at a time is allowed to transmit through a home repeater to other units assigned to that repeater.

Mobile units can change their ID numbers to either listen or talk to other mobiles, groups of mobiles or subgroups. These mobile units change their ID numbers with either manual controls or by scanning. The organization of mobile units is arbitrary and done differently by different mobile transmitter-receiver companies.

Signaling between mobile units and repeaters occurs at a subaudible 100 Hz frequency and occurs continuously and concurrently with the audio portion of the transmission. Updates are transmitted every 7-8 seconds by repeaters to mobile units to keep them informed as to which channel is available to them or when other mobile units are calling.

5-13-3 Accessing The Trunking System

Before a mobile unit can access the system, a data "handshake" with a repeater must be accomplished. When the mobile unit's push-to-talk is pressed, the mobile uses a repeater's data packet to determine if there is a free repeater channel available. If there is, that repeater becomes that mobile unit's "home" repeater. The mobile transmitter is enabled and the mobile unit transmits a data message to the repeater containing the ID code for broadcast. The mobile unit then listens for a response from the repeater for the go-ahead to transmit. When this handshake is received, transmission is enabled. Also, all listening mobiles with that repeater's ID number detect their ID, select the directed channel and unsquelch to receive voice transmission.

A. The Trunking Data Packet

The trunking data packet is a 40-bit word formatted as:

SYNC : AREA : GOTO (IN USE) : HOME : ID CODE : FREE : CHECK

SYNC (9 bits): A bit pattern used to initialize the receive data circuitry. These bits are compared by the trunking hardware to a known bit pattern. If the pattern matches, the remaining bits of the word are checked for acceptance. Patterns used by the industry at the present time are:

101011000 101010000 001010000

AREA (1 bit): Repeater systems in close proximity to others may use the same channel frequencies. These systems use this area or intermod bit as an "us-them" comparison for data acceptance. This bit is usually "0" unless two systems are in close proximity to one another.

GOTO (IN USE) CHANNEL (5 bits): These bits represent either the repeater being used or the repeater to which a mobile unit is being transferred for a transmission. These bits must be the same number (1 thru 20) as that assigned to the repeater for data acceptance in a mobile-to-repeater message. In a repeater-to-mobile message, this is the number of the repeater to be used. The mobile translates this number through a look-up table into an FCC channel pair.

NOTE

A "31" code in this location indicates a "turn-off" code for the end of transmission.

HOME CHANNEL (5 bits): In a mobile-to-repeater data message, this slot is the home repeater assigned to that mobile for the current group selection and is used for system accounting. In a repeater-to-mobile message, this contains the home repeater number of the mobile making the call, no matter which repeater is being used--the home repeater or another repeater.

ID CODE (8 BITS): In a mobile-to-repeater message, this slot contains the ID code (1-250) being used by the mobile unit for calling the receiver. In a repeater-to-mobile message, the same ID is reflected so a mobile can decide if it needs to unsquelch its receiver to listen to the voice transmission.

FREE CHANNEL (5 bits): In a repeater-to-mobile message, this slot tells a mobile which repeater (1-20) to use when it transmits. This can be the same number as the home repeater. If all repeaters are busy, this field contains a zero (0), indicating "In Use." In a mobile-to-repeater message, this contains a 31, used to fill the slot since mobiles do not use this information.

CHECK (7 bits): This field contains error check bits that are derived from all the message after (but not including) the sync. When the message is sent, a special parity operation is performed on the data and inserted into these seven bits. A receiver (mobile or repeater) performs its own computation to produce what it thinks the check should be. If the two separately derived check codes do not agree, the message is rejected by the receiver.

B. Repeater Channel Numbers

A mobile radio is programmed with a set of valid repeater numbers from 1 to 20. An RF channel number is associated with each of these repeater numbers in a mobile radio look-up table. One of these repeaters is designated the home repeater for the mobile radio.

For Example:

REPEATER LIST	CHANNEL NUMBER	MOBILE RECEIVE FREQUENCY	MOBILE TRANSMIT FREQUENCY*
3	39	851.9625	806.9625
7	79	852.9625	807.9625
11	119	853.9625	808.9625
15	159	854.9625	809.9625
19	199	855.9625	810.9625

*These channel numbers and frequencies reflect those used in the lower Trunking band. For a complete list of channel numbers and frequencies, see Appendix F.

Given a channel number, the mobile unit can compute the transmit and receive frequencies according to the following formulae:

Low Frequency Band

$$\begin{aligned} \text{Transmit RF} &= 806.0125 + [.025 \times (\text{Channel \#} - 1)\text{MHz}] \\ \text{Receive RF} &= \text{Transmit RF} + 45 \text{ MHz} \end{aligned}$$

High Frequency Band

$$\begin{aligned} \text{Transmit RF} &= 896.0000 + (.0125 \times \text{Channel \#}) \text{ MHz} \\ \text{Receive RF} &= \text{Transmit RF} + 39 \text{ MHz} \end{aligned}$$

NOTE

Radios operating in the Low Trunking Frequency Band within range of Mexico or Canada must employ a -12.5 kHz offset as required by the FCC.

Repeaters, in turn, are programmed to recognize a set of ID codes. Any received data stream from mobiles with IDs not in a repeater's table are discarded.

C. Mobile Calling a Free Repeater

The following illustrates a simple repeater/mobile handshake. The bit transmissions are formatted as:

SYNC (S): AREA: GOTO: HOME: ID CODE: FREE: CHECK (C)

The following illustrates a Handshake sequence:

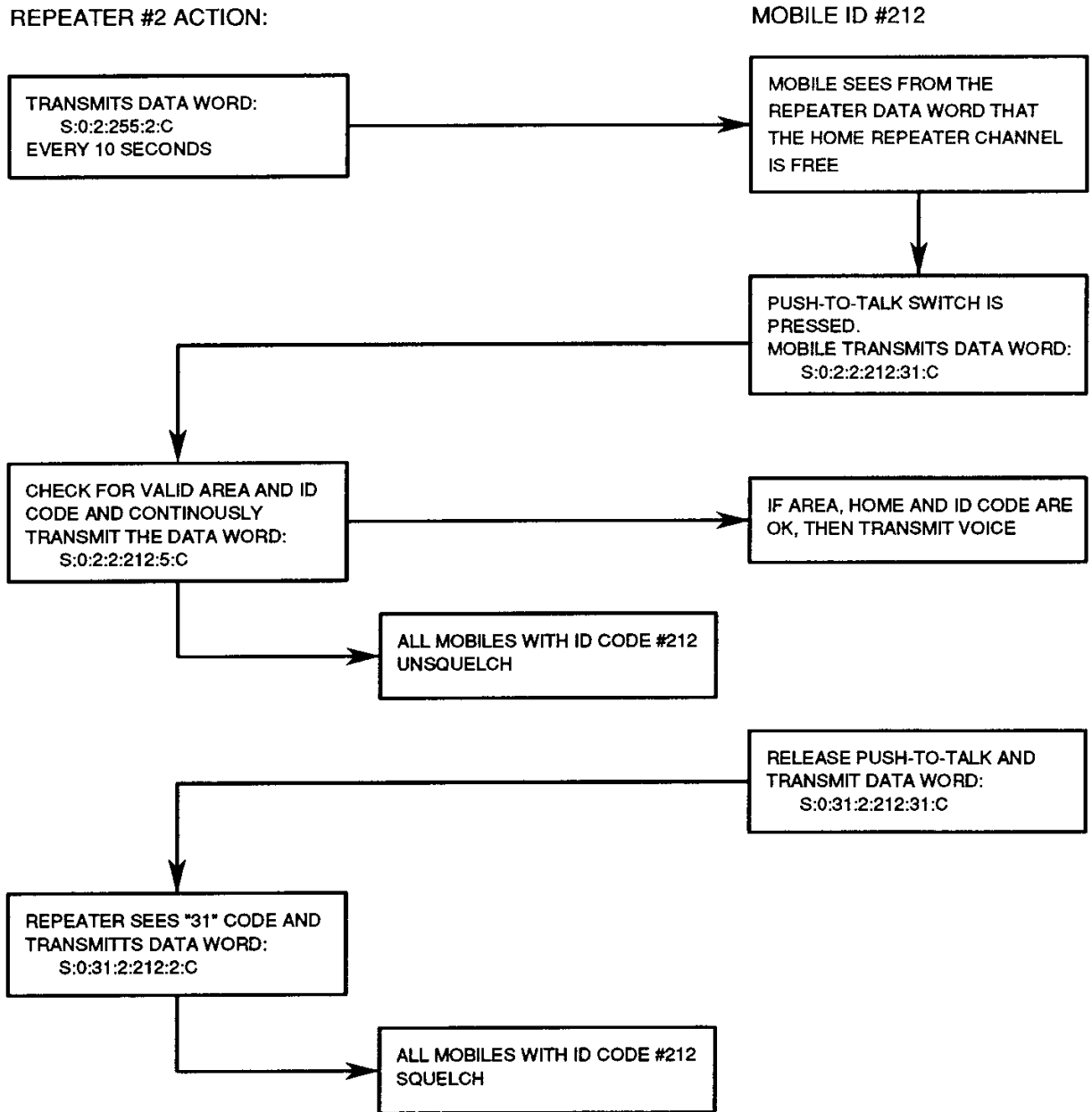

Figure 5-6 Simple Handshake Sequence

6104001

D. Mobile Handoff

When a home repeater is busy, it will instruct a mobile unit to change its channel to the next free repeater in the system. A handoff will occur in this manner:

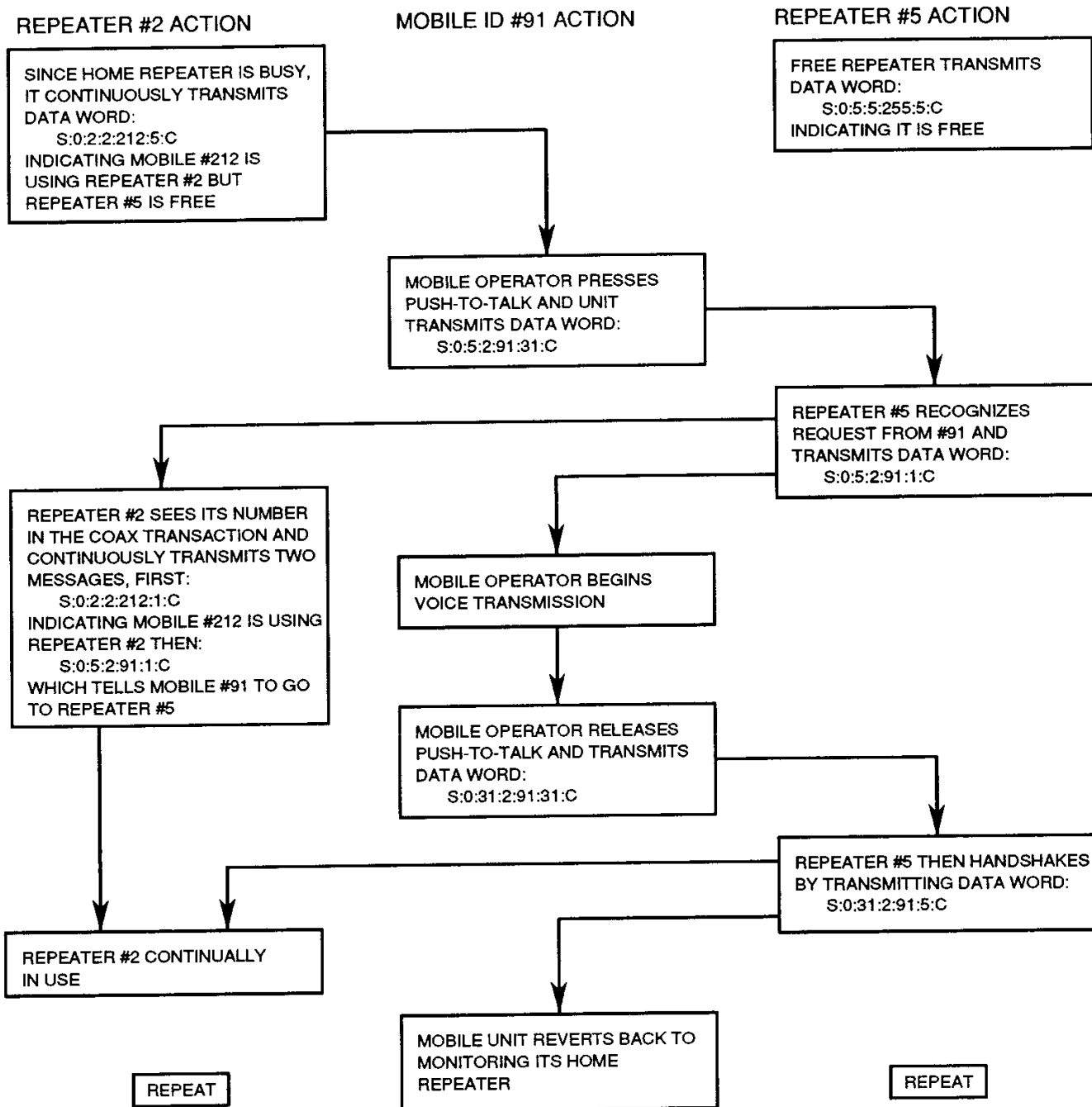
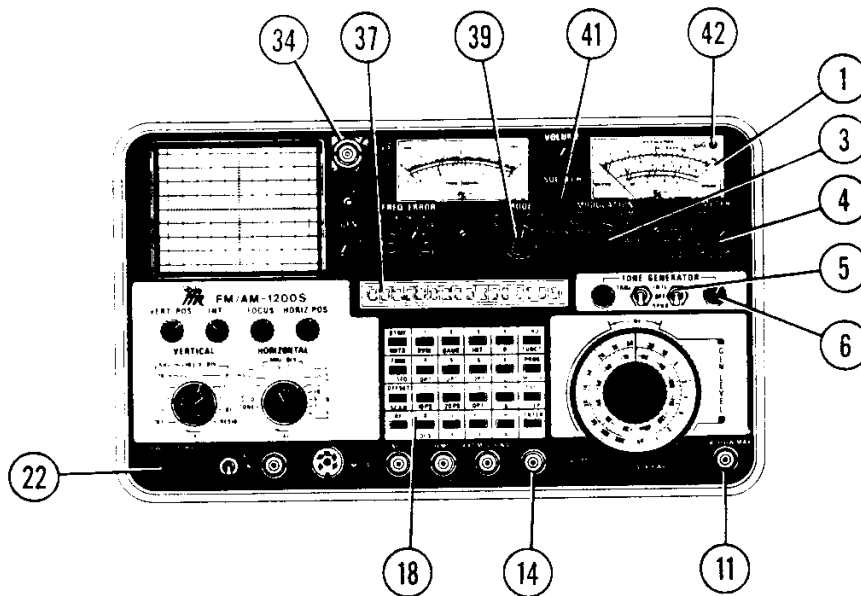

Figure 5-7 Handoff Sequence

6104002





FM/AM-1200S CONNECTORS AND INDICATORS APPLICABLE TO TRUNKING TEST OPERATION:

- 1 MODULATION METER
- 6 VAR Tone Level Control
- 11 T/R Connector
- 14 DUPLEX Connector
- 34 ANT Connector
- 37 VFD
- 41 SQUELCH Control
- 42 SIG Indicator Lamp

Figure 5-8 FM/AM-1200S Front Panel Controls Applicable to Trunking Radio Tests

CONTROL	SETTING
3 MODULATION Selector Control	"FM MID"
4 Modulation METER Control	"2 kHz/%x10"
5 VAR Tone Selector Switch	"INTL"
18 Keyboard	As required
22 PWR/OFF/BATT Switch	"PWR" or "BATT"
24 VERTICAL Attenuator Selector Control	2 kHz/%x10
26 HORIZONTAL Sweep Selector Control	10 mS/DIV
39 MODE Selector Control	GEN

Table 5-11 FM/AM-1200S Front Panel Controls Applicable to Trunking Radio Tests

The FM/AM-1200S has three (3) trunking tests operating modes available to it. Each of these modes is entered by pressing:   .

After the Trunking Test Mode is accessed, the following message appears on the VFD:

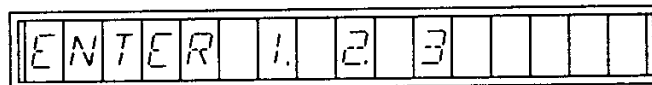





By pressing the appropriate number key, the following test modes will be executed:

- 1 = Simple Encode/Simple Decode Modes for both mobile units and repeaters and Repeater Access Test.
- 2 = Repeater Simulation Mode to test mobile units and handoffs.
- 3 = Mobile Radio Simulation Mode to test repeaters and handoffs. (Requires two or more repeaters).

NOTE

If the UUT uses the lower band of trunking frequencies (806 MHz to 866 MHz) proceed to the desired tests from this point.

If the UUT uses the upper band of trunking frequencies (896 MHz to 940 MHz), press:     . The following screen appears on the VFD:

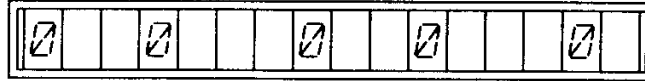

The first programming location on the screen:

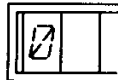

flashes on and off, indicating this is the cursor position. Press:  . This programming location now shows:

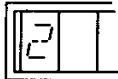

Press:  . The desired tests Trunking systems using the upper frequency band may now be performed.

5-13-4 Simple Encode/Simple Decode Modes And Repeater Access Test

This mode is used to determine if a transmitter/receiver UUT is properly receiving and utilizing a signal from the FM/AM-1200S, which simulates the encoding and decoding processes of either a mobile unit or a repeater (both can be tested in a similar fashion). To test these modes, perform the following steps:

STEP	PROCEDURE
------	-----------

1.	Set the FM/AM-1200S front panel controls to the setting as listed in Table 5-11.
----	--

2.	Connect the UUT to the FM/AM-1200S as indicated:
----	--

For testing mobile unit Encode or Decode, connect UUT to T/R Connector (11).

For testing repeater Encode, connect UUT receiver to T/R Connector (11) and UUT transmitter to 50 Ω load.

For testing repeater Decode, connect UUT receiver to DUPLEX Connector (14) and UUT transmitter to T/R Connector (11).

NOTE



RF #0 is the mobile Transmit/Receive frequency for Encode/Decode operations.

3. Adjust the VAR Tone Level Control (6) for a reading of 800 Hz on the MODULATION Meter (1).

NOTE

If no tone is being generated, enter a 100 Hz tone as described in section 4-10 of this manual.

4. Set Mode Selector Control (39) to REC.
5. Adjust SQUELCH Control (41) until SIG Indicator Lamp (42) goes out.
6. Simple Encode Mode Test
 - a. Program RF Memory #0 to UUT receive frequency
 - b. Place the MODE Selector Control (39) to GEN.

- c. Press:   

The following display appears on the VFD:

E	N	T	E	R	1.	2.	3				
---	---	---	---	---	----	----	---	--	--	--	--

- d. Press:  . An open programming format for encode appears on the VFD in the following configuration:

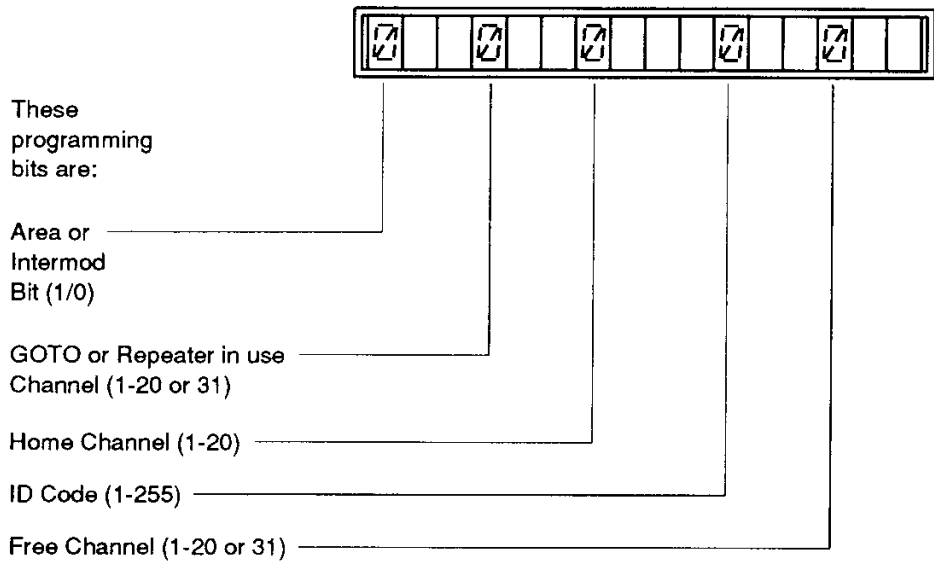



6103002

NOTE



When testing a repeater, the "Repeater in Use" number and the "Home Channel" is the same (the repeater number.) The "Free Channel" number is "31."

e. Place Programming Template 1 over the FM/AM-1200S front panel.

f. Use the  and  keys to move the cursor to the desired location on the VFD and enter each digit of the data required.

NOTE

The fields shown are limited to the maximum values indicated. If a number higher than the maximum value is entered, the field will show the maximum allowable number; i.e., if "50" is entered for the "GOTO Channel", the maximum number of "31" will display.

- g. Press:    . The following display appears:

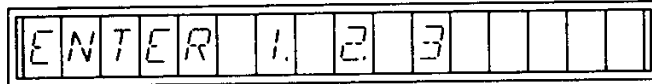





- h. Press:  . The FM/AM-1200S outputs the programmed bit pattern about once every 150 ms. This bit pattern opens the squelch of the UUT.

NOTE

It may be necessary to turn the GEN/LOCK control (32) to the "1 o'clock" position while watching for flatness of the trace on the CRT (31). Continue to turn the control until the UUT decodes.

7. Simple Decode Test

- a. Program RF Memory #0 to UUT transmit frequency
 b. Set the MODE Selector Control (39) to REC.

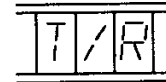

- c. Press:     . An "RF INPUT" programming message appears on the VFD:



The RF INPUT location will flash.

NOTE

For testing repeaters and mobile units by direct cable transmission, program "RF INPUT" to "T/R" and connect mobile or repeater transmitter to T/R Connector (11). For testing mobile unit "Off-the-Air" transmissions, program the "RF INPUT" to "ANT" and install an antenna to the ANT Connector (34).

- d. If necessary, press the  key to toggle the RF INPUT to the desired setting, then press  . The VFD shows:

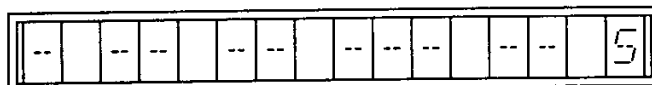

- e. Press and hold down the UUT "Push-to-Talk" switch. When the UUT output is received, the blank screen is replaced by one containing values determined by UUT output. For example:

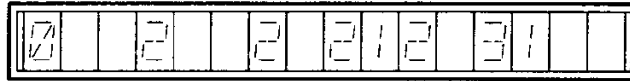

This would translate as:

Area or Intermod
Bit (0, 1)

GOTO Channel or
Repeater in Use
(1-20 or 31)

Home Channel (1-20)

ID Code (1-255)

Free Channel (1-20 or 31)

Error Code

6103004

NOTE

"S" (Sync Code Error) will flash at the Error Code location during mobile transmit and will not appear during repeater transmit. If "S" appears and stays on, it indicates a Sync Code Error (no sync code found). If "C" appears, it designates check bits error (sync code found but check bits in error). A "(blank)" in this area indicates no error found.

When the UUT is in idle mode, the "ID CODE" shows "255," indicating a "Free Repeater."





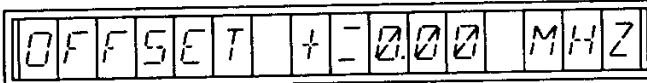

- f. Release the UUT "Push-to-Talk" switch. The mobile unit transmits a data message informing the Repeater (the FM/AM-1200S) of the release of the PTT. The Repeater then orders other mobile units listening on the channel to squelch.

8. Repeater Access Test.

This test measures a mobile unit's performance by simulating a repeater's sequence of idle and Push-to-Talk acknowledgement. To perform a Trunking equipment test, the FM/AM-1200S (acting as a repeater) must be informed of the offset used between the Trunking Receive and Transmit frequencies.

- a. Press:  . The following appears on the VFD:







- b. If the UUT operates in the lower band of Trunking frequencies (806 MHz to 866 MHz), press:    .
- c. If the UUT operates in the high band of Trunking frequencies (896 MHz to 940 MHz), press:    .

NOTE

RF #0 must be set to the UUT's transmit frequency.





- d. Place the MODE Selector (39) to DUP.
- e. Program the Trunking parameters of the UUT as described for the "Simple Encode Test", Section 5-13-4, Step 6-d.

- f. Press:     . The VFD displays the programmed parameters entered in step "e." above.

- g. Press the Push-to-Talk switch (PTT) on the UUT. When the FM/AM-1200S detects a transmission, it continuously transmits a Push-to-Talk acknowledge message, causing the UUT to lock on (unsquelch) its transmitter and allow voice transmission. Transmitted sound deflects the MODULATION Meter (1).

NOTE



The FM/AM-1200S only allows one repeater access. The test will end with the release of the PTT. To repeat

the test, press     again.

5-13-5 Repeater Simulation Mode

This test may be used to check the operation of a mobile radio unit by using the FM/AM-1200S to simulate the workings of a repeater to perform such tests as a "Simple Handshake" or a "Repeater Handoff". For this test, the FM/AM-1200S must be programmed for several parameters relating to repeater functions using these steps:

STEP PROCEDURE

1. Press:    . The following display will appear on the VFD:

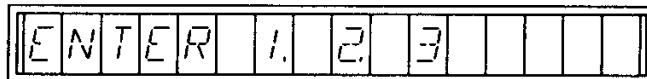

2. Press:  . An open programming format for the repeater simulation will appear on the VFD in the following configuration:

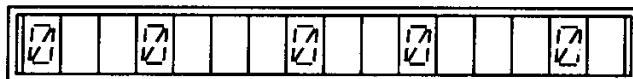

These programming bits are:

Border Offset (0,1 or 2 See NOTE Below)

Home Repeater Number (1-20)

Home Repeater Channel Number (1-600 with Border Offset 0 or 1, 1-399 with Border Offset 2)

Free Repeater Number (1-20)

Free Channel Number (1-600 with Border Offset 0 or 1, 1-399 with Border Offset 2)

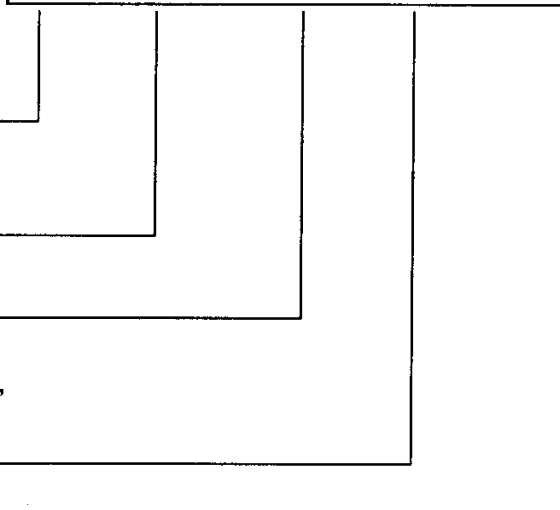



6103003

NOTE

A "2" entered as the "Border Offset" bit allows testing of Trunking radio equipment utilizing the High Trunking Frequency Band (896 MHz to 935 MHz) in Tests 1, 2 and 3.

3. Place Programming Template 2 over the FM/AM-1200S front panel.



4. Use the  and  keys to move the cursor to the desired location on the VFD and enter each digit of the data required.

STEP

PROCEDURE

5. Simple Handshake Test. To simulate the FM/AM-1200S making a Simple Handshake with a mobile unit, perform the following steps:

a. Place the MODE Selector Control (39) to DUP.

- b. Press:    . The following display appears on the VFD:

ENTER 1 2 3

- c. Press:  . The following display appears:

ENTER TEST 1-2

- d. Press:  . As the FM/AM-1200S begins transmitting the programmed data word to the UUT, the VFD displays:

HOME IDLE

The simulated repeater unit (the FM/AM-1200S) looks for a valid mobile push-to-talk request.

- e. Press the UUT's "Push-to-Talk" switch. If the incoming data word is valid, the VFD displays:

PUSH TO TALK

Voice transmission may now take place.

- f. Release the UUT's "Push-to-Talk" switch. The UUT transmits a data word containing the end code and the VFD displays:





RELEASED PTT

The FM/AM-1200S now sends the last handshake message once.

NOTE

If any of the above VFD displays fail to appear, the test has failed.

6. Repeater Handoff

- a. Press:     . This will make the FM/AM-1200S simulate a repeater making a "Handoff". The following message should appear on the VFD:

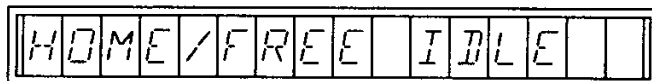

This indicates the FM/AM-1200S is acting as a "Home Repeater".

- b. The operator presses the mobile unit's PTT. The Mobile UUT should switch RF frequencies to the free channel as indicated by the preprogrammed information. Upon receiving the PTT message at the free repeater frequency, the following will be displayed on the VFD:

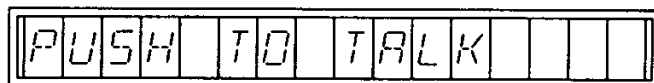

NOTE

Two or more interrogations from the mobile may be required before the above message is displayed on the VFD.

- c. The Free Repeater (the FM/AM-1200S) will acknowledge the PTT from the mobile unit by transmitting the proper handshake word. At this time, the free repeater (the FM/AM-1200S) is looking for a release of the mobile unit's PTT.
- d. The operator releases the mobile unit's Push-to-Talk switch. The UUT will then transmit the Push-to-Talk release message to the FM/AM-1200S. When it is received, the VFD will display:

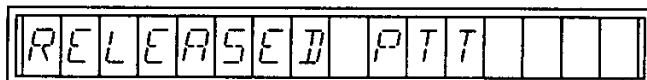

NOTE

If any of the above steps fail to occur, the test has failed.

5-13-6 Repeater Handshake Test (Mobile Unit Simulation Mode)





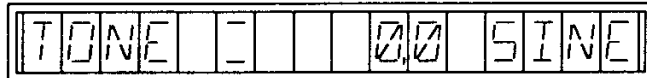

This test is used to check the operation of a repeater or repeater system. Handshake capability of a repeater is tested by using the FM/AM-1200S to simulate the workings of a mobile unit. To perform this test, follow these steps:

STEP PROCEDURE

1. Set up FM/AM-1200S as shown in Table 5-11.

2. Press:  . The following appears on the VFD:





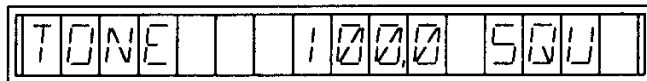

3. Press:      , then  again to set the tone to:



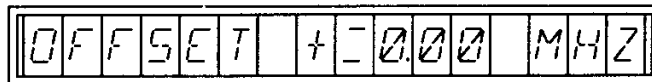



4. Set VAR Tone Selector Control (5) to "INTL," then adjust VAR Tone Level Control (6) for a 1 kHz reading on the MODULATION METER (1).

5. Press:  . The following appears on the VFD:



a. If the UUT operates in the lower band of Trunking frequencies (806 MHz to 866 MHz), press:   and  , if necessary, to toggle OFFSET to "-", then press  .



b. If the UUT operates in the high band of Trunking frequencies (896 MHz to 940 MHz), press:   and  , if necessary, to toggle OFFSET to "-", then press  .

7. Program RF #0 to the UUT's transmit frequency.

8. Set the MODE Selector Control (39) to DUP. Adjust SQUELCH Control (41) until SIG Indicator Lamp (42) just goes out.

9. Connect coax between repeater transmitter and FM/AM-1200S T/R Connector (11).

10. Connect coax between repeater receiver and FM/AM-1200S DUPLEX Connector (14).

11. Press    . The following display appears on the VFD:

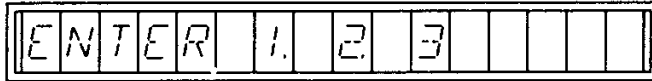

12. Press:  . An open programming format for encode appears on the VFD in the following configuration:



These programming bits are:

Area or Intermod Bit (1/0)

GOTO or Repeater in use Channel (1-20 or 31)

Home Channel (1-20)

ID Code (1-255)

Free Channel (1-20 or 31)

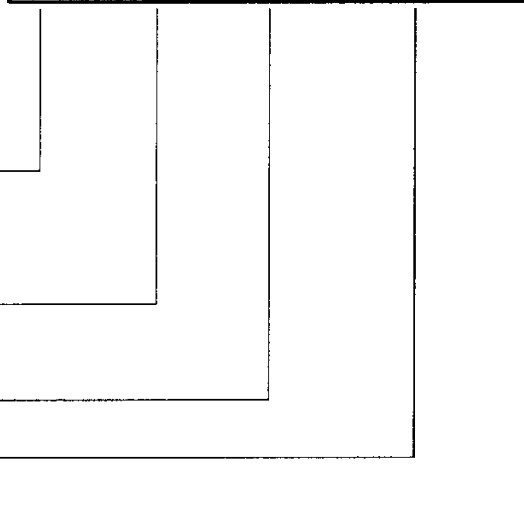



6103002

NOTE



When testing a repeater, the "Repeater in Use" number and the "Home Channel" is the same (the repeater number.) The "Free Channel" number is "31."

13. Place Programming Template 1 over the FM/AM-1200S front panel.

14. Use the  and  keys to move the cursor to the desired location on the VFD and enter each digit of the data required.

NOTE

The fields shown are limited to the maximum values indicated. If a number higher than the maximum value is entered, the field will show the maximum allowable number; i.e., if "50" is entered for the "GOTO Channel", the maximum number of "31" will display.

15. Press:    . The following display will appear on the VFD:



16. Press:  . An open programming format for the repeater simulation will appear on the VFD in the following configuration:



These programming bits are:

Border Offset (0,1 or 2 See NOTE Below)

Home Repeater Number (1-20)

Home Repeater Channel Number (1-600 with Border Offset 0 or 1, 1-399 with Border Offset 2)

Free Repeater Number (1-20)

Free Channel Number (1-600 with Border Offset 0 or 1, 1-399 with Border Offset 2)

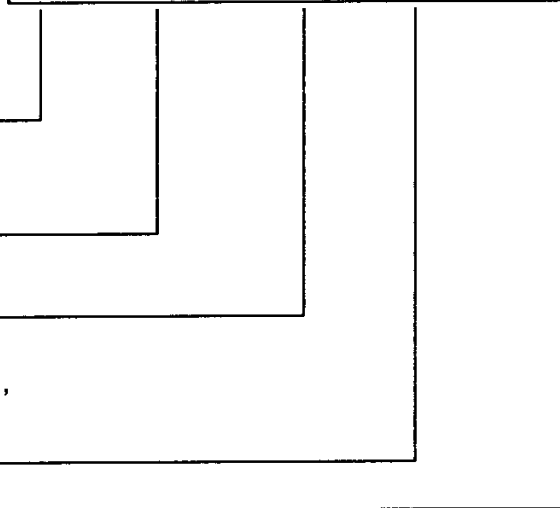





6103003

NOTE

A "2" entered as the "Border Offset" bit allows testing of Trunking radio equipment utilizing the High Trunking Frequency Band (896 MHz to 935 MHz) in Tests 1, 2 and 3.

17. Place Programming Template 2 over the FM/AM-1200S front panel.

18. Use the  and  keys to move the cursor to the desired location on the VFD and enter each digit of the data required.

19. Press    . The following appears on the VFD

```
ENTER 1 2 3
```

20. Press  to select the Mobile Unit Simulation Mode. At this time, the FM/AM-1200S is monitoring the incoming digital data from the repeater UUT and looking for a valid data word containing its ID code. The following message displays:

```
HOME WAITING
```

When the correct data word is found, the following displays on the VFD:

```
HOME IDLE
```

21. Press:  to simulate a Push-to-Talk.

The FM/AM-1200S continuously transmits this PTT message to the repeater UUT. Simultaneously, the FM/AM-1200S will monitor the UUT's output looking for a valid return message containing the simulated mobile unit's ID Code. When this message is received, the following will display on the VFD:

```
H/S RECEIVED
```

22. Press:  . The FM/AM-1200S transmits a PTT release data word to the UUT. In return, the incoming data from the UUT is monitored by the FM/AM-1200S, looking for the handshake message. When the message is found, the following is displayed on the VFD:

```
HOME COMPLETED
```

This indicates the repeater recognized the mobile unit's (the FM/AM-1200S's) PTT released message.

NOTE

If any of the above steps fail to occur, the test has failed.

5-13-7 Repeater Handoff Test (Mobile Unit Simulation Mode)

Handoff capability is tested using the FM/AM-1200S to simulate a mobile unit in need of a handoff to a second repeater while a mobile unit or a second FM/AM-1200S is used to keep the Home Repeater channel busy. Set up the Repeater system and FM/AM-1200S as show in Figure 5-8.

CAUTION

DO NOT EXCEED 1/4 WATT INPUT TO FM/AM-1200S ANTENNA CONNECTOR. DAMAGE TO TEST SET WILL RESULT.

NOTE

If a sample port is not available on combiner, use of a directional coupler is required to obtain the desired 1 mW signal at the FM/AM-1200S ANT connector.

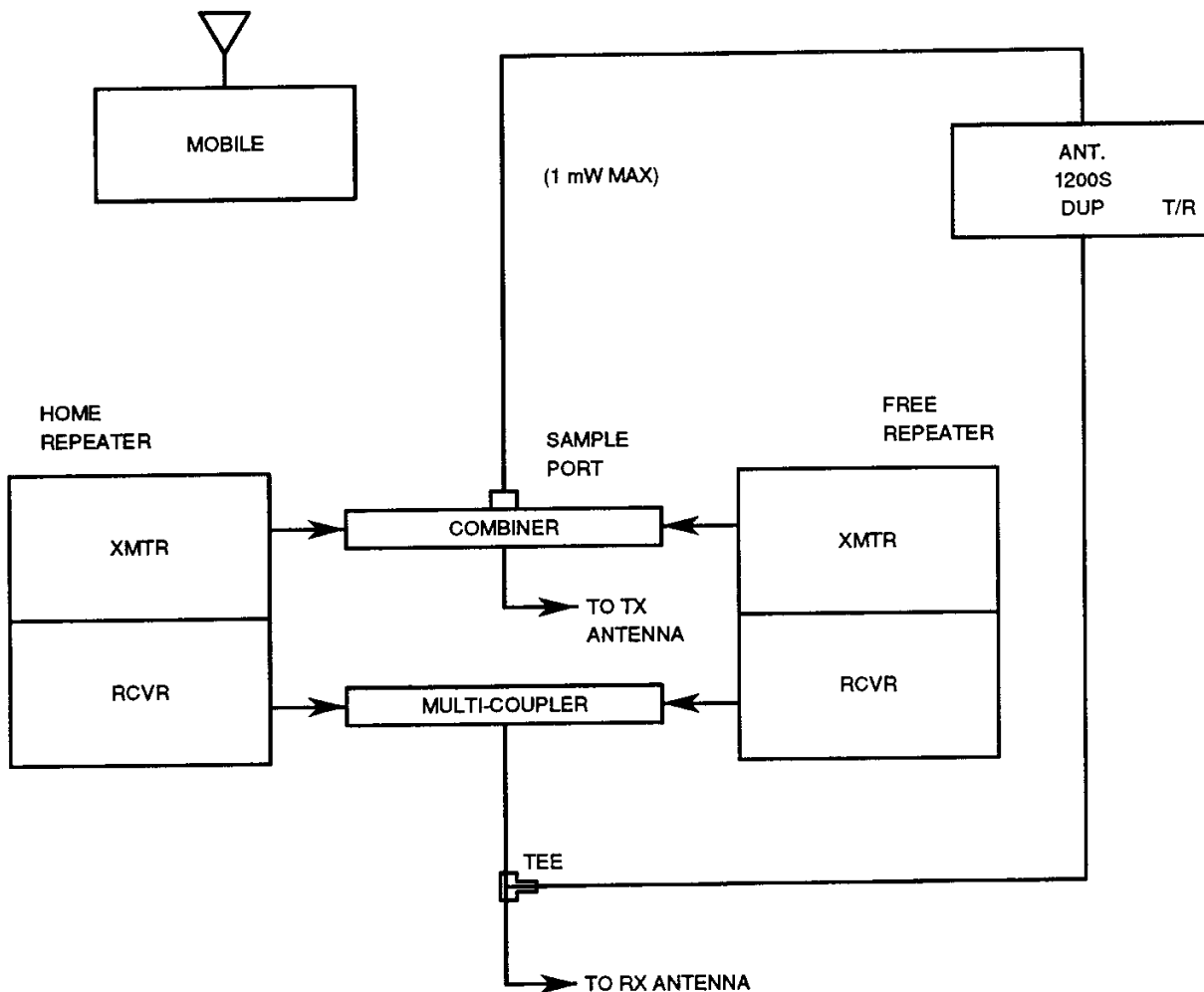

Figure 5-8 Repeater Handoff Test Setup

6104003

STEP

PROCEDURE

1. Set up FM/AM-1200S as shown in Table 5-11.
2. Program FM/AM-1200S (used to test the handoff capability of Repeater #1 as follows:

a. Press:    .





b. Enter the digits of the Home Repeater's transmit frequency, then press  .



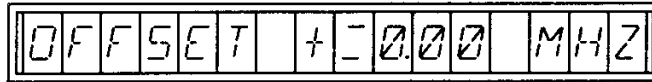

NOTE











Use Appendix F to find mobile transmit and receive frequencies for the Channel Number used.

c. Since the FM/AM-1200S will both transmit and receive, Offset is needed. Press:  . The following appears on the VFD:



If the UUT operates in the lower band of Trunking frequencies (806 MHz to 866 MHz), press:   and  , if necessary, to toggle OFFSET to "-", then press  .









If the UUT operates in the high band of Trunking frequencies (896 MHz to 940 MHz), press:   and  , if necessary, to toggle OFFSET to "-", then press  .

d. Press:         , then  (for square wave)  .

e. Press:    .





f. Place VAR Tone Selector Switch (5) in "INTL" position.

g. Adjust VAR Tone Level Control (6) for 1.0 kHz Deviation.

- h. Press:     and program the parameters of the simulated mobile unit (FM/AM-1200S) used to call the UUT (Repeater #1) on its busy Home Repeater channel.
- i. Press:     and program the parameters of the Home (#1) and Free (#2) Repeater so the FM/AM-1200S will handoff to the Free Repeater.

NOTE

It may be necessary to use the FM/AM-1200S to perform repeater encode and decode tests (5-13-6) on Repeater #2 to determine the assigned repeater system number of Repeater #2.

- j. Turn MODE Switch (39) to "DUP."
- k. Adjust SQUELCH Control (41) until SIG Indicator Lamp (42) just goes out.
3. If a mobile unit is used to keep the Home Repeater Channel of Repeater #1 busy, press and hold its PTT switch..
4. On FM/AM-1200S, press:     . The VFD shows the following message as Repeater #1 waits for a mobile access:



When the FM/AM-1200S attempts to call the busy Home Repeater, the following message is seen briefly on its VFD to indicate the fact that the channel is in use:

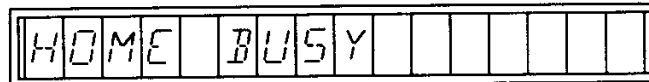

The UUT then attempts a "Handoff" of the mobile unit (the FM/AM-1200S) by transmitting a handoff message to it. The FM/AM-1200S will change frequencies (channels) to one derived from the channel information contained in the last handoff message and preprogrammed channel values in the FM/AM-1200S.

When the free repeater idle message is found, the VFD displays:

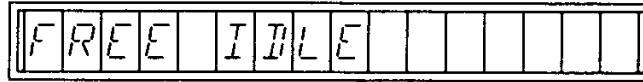

F	R	E	E	I	D	L	E		
---	---	---	---	---	---	---	---	--	--

After the free repeater idle message is received, press:
on the Keyboard (18) to simulate PTT. The VFD displays:



H	/	S		R	E	C	E	I	V
E	D								

indicating the new (handed off) repeater recognized the output from the FM/AM-1200S.

5. Press:  on the Keyboard (18) to simulate PTT release. The VFD message:



F	R	E	E		C	O	M	P	L
E	T	E	D						

displays on the VFD to indicate mobile completion.

NOTE

If any of the above steps fail to occur, the test has failed.

**5-14 CELLULAR TESTING – AMPS: OPTION 15 (FM/AM-1200S ONLY)
 ETACS: OPTION 16 (FM/AM-1200S ONLY)**

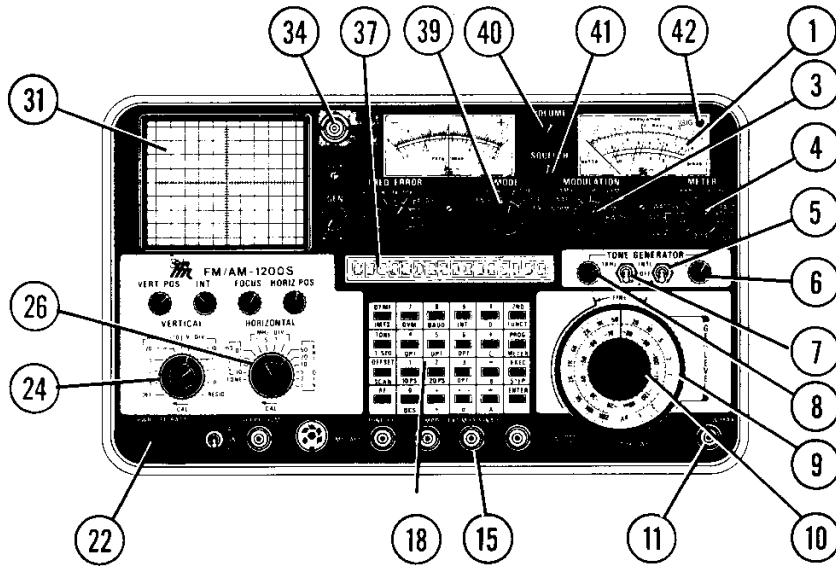

FM/AM-1200S CONNECTORS AND INDICATORS APPLICABLE TO CELLULAR TEST OPERATIONS:

- 1 MODULATION METER
- 6 VAR Tone Level Control
- 8 1 kHz Tone Level Control
- 9 RF Level Attenuator Vernier Control
- 11 T/R Connector
- 14 DUPLEX Output Connector
- 15 EXT MOD/SINAD Connector
- 24 Scope VERTICAL Attenuator Selector Control
- 31 CRT Display
- 34 ANT (Antenna) Connector
- 37 VFD
- 40 VOLUME Control
- 41 SQUELCH Control
- 42 SIG Indicator Lamp

Figure 5-9 FM/AM-1200S Front Panel Controls Applicable to Cellular Testing Operations

CONTROL	SETTING
3 MODULATION Selector Control	"FM MID"
4 Modulation METER Control	"6 kHz %x10"
5 VAR Tone Selector Switch	"INTL"
7 1 kHz Tone Selector Switch	"OFF"
10 RF Level Attenuator Control	50 dBm
18 Keyboard	As required
22 PWR/OFF/BATT Switch	"PWR" or "BATT"
26 HORIZONTAL Sweep Selector Control	.1 MHz/Div
39 MODE Selector Control	"GEN"

Table 5-12 FM/AM-1200S Front Panel Controls Applicable to Cellular Testing Operations

5-14-1 GENERAL

The AMPS (Advanced Mobile Phone System) Cellular Option (Option 15) and the TACS (Total Area Communications System) or ETACS (Enhanced Total Area Communications) Cellular Option (Option 16) for the FM/AM-1200S allows an operator to test Cellular Telephones by using the FM/AM-1200S to simulate a Cell Site. The Cellular Test procedures for the FM/AM-1200S include instructions for Parameter Setup, Manual/Auto Test Procedures, Test Result Review and a section on Remote Cellular Test Commands for use with an RS-232 compatible external device.

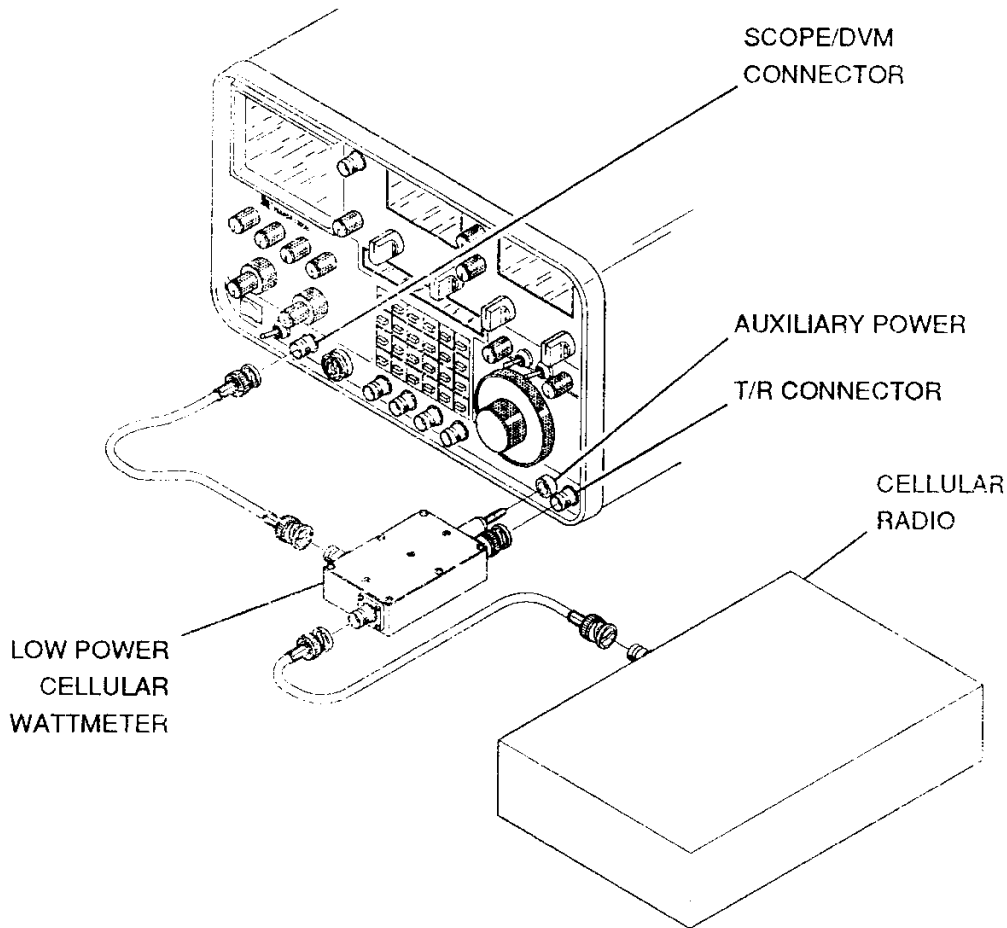

Figure 5-9A Cellular Powermeter Test Hookup Diagram

The Low Power Cellular Wattmeter is used in the following tests:

- 5-14-3 Manual Mobile-to-Cell Call
- 5-14-4 Meter Displays During Cellular Testing
- 5-14-9 Manual Cell-to-Mobile Call and Auto Handoff Test
- 5-14-15 Cellular Auto Test Procedure
- 5-14-18 RS-232 Remote Cellular Commands

NOTE

When measuring power, using the external Cellular Power Meter, remember the cellular telephone may not have a 50Ω impedance at the antenna. These connector and cable losses may cause a mismatch and false readings. The coupler specification is $\pm 15\%$ for power and $< 3\%$ for voltage output. The AMPS specification for power output is $\pm 15\%$. The E-TACS specification for power output is ± 3 dB. The DVM specification is $\pm 10\%$. The technician must make individual judgement about the failure of a UUT.

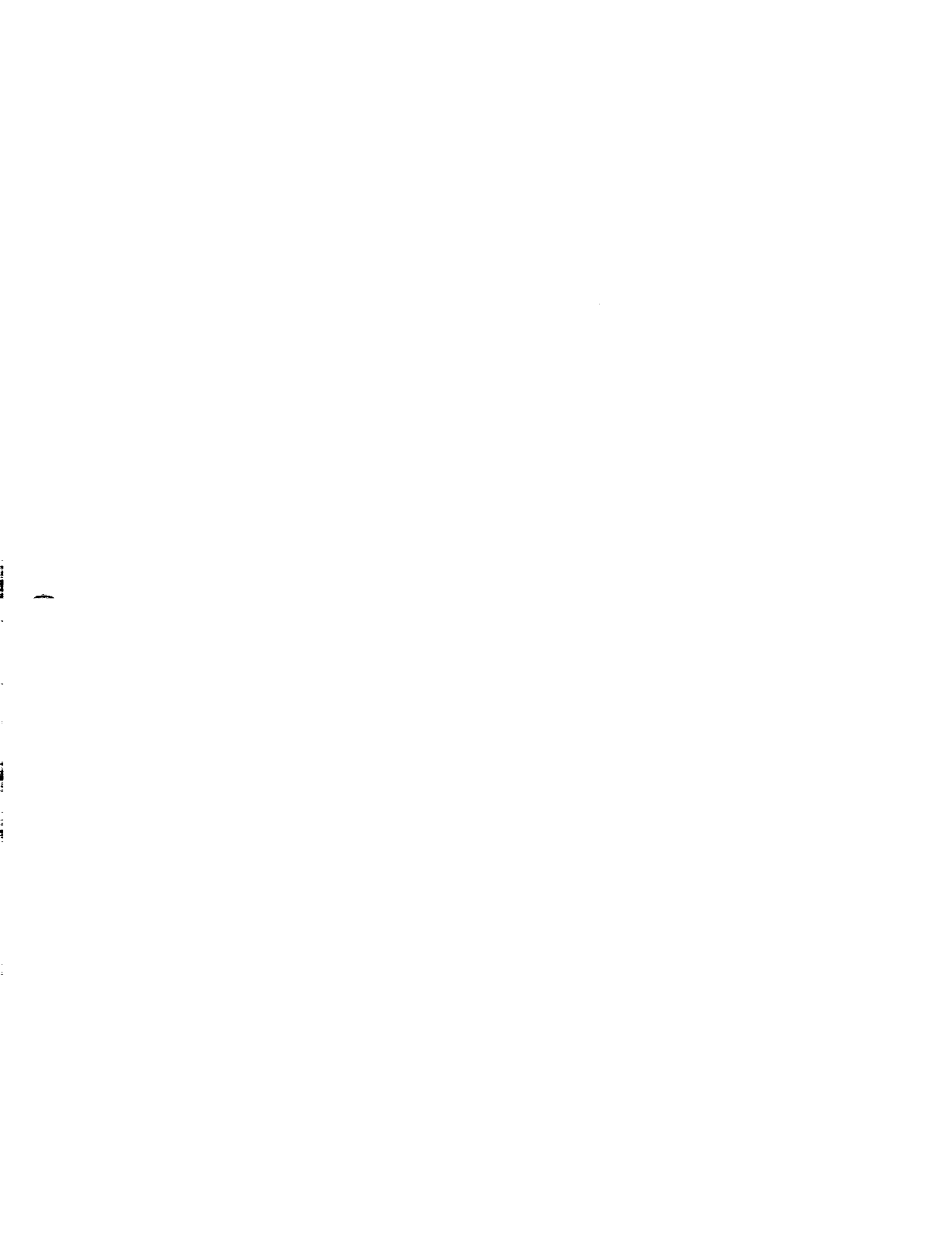

5-14-2 INITIAL SETUP

Begin the Cellular Test Procedure by performing the following steps:

STEP	PROCEDURE
1.	Set the FM/AM-1200S front panel controls to the setting as listed in Table 5-12.
2.	Connect the Cellular Wattmeter per Figure 5-9A.
3.	Adjust VAR Tone Level Control (6) for an indication of 2 kHz deviation (1.7 kHz deviation for ETACS units) on the MODULATION Meter (1).

NOTE



If no tone is being generated, enter a tone as described in section 4-10 of this manual. This tone will be overridden by the FM/AM-1200S Cellular Test programming. A tone of 6000 kHz is recommended since this will approximate the SAT frequency.



4. Set VAR Tone Selector Switch (5) to "OFF".
5. Set 1 kHz Tone Selector Switch (7) to "INTL".
6. Adjust 1 kHz Tone for an 8 kHz deviation indication on the MODULATION Meter (1).
7. Set 1 kHz Tone Selector Switch (7) to "OFF".
8. Set VAR Tone Selector Switch (5) to "INTL".
9. Set MODE Selector Control (39) to "DUP".
10. Adjust the VOLUME Control (40) as desired.

NOTE

If the volume is set at too high a level, feedback from the microphone in the UUT may cause deterioration of tested modulation readings.

11. Adjust the SQUELCH Control (41) until the SIG Indicator Lamp (42) just goes out.
12. Set MODE Selector Control (39) to "GEN".

13. On Keyboard (18), press:  

14. Press the  or  key until the following appears on the VFD Display (37):







15. Press:  The word "ON" will appear on the VFD Display (37):



16. Parameter Setup

In order to successfully test a cellular telephone, the FM/AM-1200S must be informed of the values of several parameters (variables) pertaining to the cellular system equipment being tested.

a. To program these parameters, press:   

A list of Cellular Test Programming screens will appear on the VFD Display (37). To review the list, press  or 

The parameters may be edited or values entered by using the FM/AM-1200S keyboard (18).

The list of VFD display screens, the parameter name and the range of each include:



I.D. Number 000 to 999

NOTE

The I.D. Number is a test reference number only. The 3-Digit number will appear on the Test Printout (See Figures 5-10 and 5-11) and may be used as a Tracer Number for the Cellular Telephone under test.

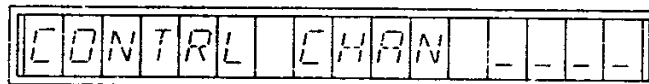

Control Channel

AMPS System A: 313-333
 AMPS System B: 334-354
 E-TACS System A: 23- 43
 E-TACS System B: 323-343

VOICE CHAN _ _ _ _

Voice Channel

AMPS: 1-1023
TACS: 1-1000
E-TACS: 0-600 or 1329-2047

HOME/ROAM = HOME = ROAM

Home/Roam Select

Any digit key toggles through selections

MIN 000-000-0000

Mobile ID Number

Digits or #, *

SND 000000000000

Serial Number (AMPS Format)



SNX

SNO

Unit Serial Number

NOTE

AMPS Mobile Telephone Serial Numbers may be entered as Decimal digits (SND), Hexadecimal (SNX) or Octal (SNO)—note that the UUT serial number is listed in all three formats on the test printout form (See Figure 5-10). These serial formats are equivalent and the FM/AM-1200S will automatically convert an entered serial number from one base to another; e.g., a serial number entered in Hexadecimal format will be converted automatically to decimal digits and Octal and vice versa. To access the correct format when entering the UUT serial number, press

the  key to scroll between the "SND," "SNX" and "SNO" programming screens. Press  to enter the desired format into operation.

SN 000000000000

Serial Number (TACS or ETACS Format)

SAT FREQ 5970 HZ

SAT Frequency Select

6000 HZ

Any digit key toggles through selections

6030 HZ

HOME ID 0000

Home or Area ID

|| | | | | D C C = 0 | | | | ||

Digital Color Code

|| = | 1 | ||

|| = | 2 | ||

Any digit key toggles through selections

|| H A N D O F F E N A B L E = | 1 | ||

Enable Handoff Test

|| 0 ||

Any digit key toggles through selections

|| H A N D O F F B E G _ _ _ _ ||

Handoff Test Begin at Channel # AMPS: 1-1023
TACS: 1-1000
E-TACS: 0-600
or 1329-2047

|| H A N D O F F E N D _ _ _ _ ||

Handoff Test End at Channel # AMPS: 1-1023
TACS: 1-1000
E-TACS: 0-600
or 1329-2047

|| H A N D O F F I N C _ _ _ _ ||

Handoff Test Increment 1-999
(Number of Channels between Handoff points)

|| H A N D O F F R A T E _ _ _ _ ||

Handoff Rate 0-9 seconds
(Length of delay between Handoffs)

|| S I N A D E N A B L E = | 1 | ||

SINAD Test Enable

|| = | 0 | ||

Any digit key toggles through selections

|| S I N A D D B = | X X | | | ||

Set SINAD dB Level 0 dB to 99 dB

```

  | F | O | R | M | A | T | = | A | M | P | S |   |
  |---|

```

Test Format

```

  |   |   |   |   |   |   |   |   |   |   |
  |---|

```

NOTE

The "Test Format" VFD displayed is dependent on the Option installed. Option 15 (AMPS) or Option 16 (E-TACS) will display the appropriate screen.

```

  | P | R | I | N | T |   | E | N | A | B | L | E |   | = |   | 1 |
  |---|

```

Printout Enable

```

  |   |   |   |   |   |   |   |   |   |   |
  |---|

```

Any digit key toggles through selections

NOTE

If a printer is not connected to the FM/AM-1200S and

```

  | P | R | I | N | T |   | E | N | A | B | L | E |   | = |   | 1 |
  |---|

```

is selected, test results may be slowed as the test set searches for the output device. If:

```

  | P | R | I | N | T |   | E | N | A | B | L | E |   | = |   | 0 |
  |---|

```

is selected, press  and proceed to 5-14-3.

b. RAM Test

When the PWR/OFF/BATT Switch (22) is set to the "PWR" position, a RAM Test occurs. Results of this test will output to the printer output pins of the RS-232 Connector (43). If the test is successful and a printer is connected to this connector, the message "RAM OK, PRINTER OK" will print out.

NOTE

"PRINT ENABLE" does not have to be programmed for this output to print. The Printer Parameters for the printout are:

```

BAUD RATE = 9600
DATA BITS = 8
SET STOP BITS = 1
SET PARITY = NONE

```

c. Printer Parameters

When a printout of the Cellular Test is desired, i.e., when:

PRINT ENABLE = 1

is selected, the FM/AM-1200S must also be informed of the printer's parameters through a series of programming screens.

To access these screens, press 

Printer Programming screens include:

SET BAUD RATE

Set Printer Baud Rate	0 = 110	4 = 2400
	1 = 300	5 = 4800
	2 = 600	6 = 9600
	3 = 1200	

SET DATA BITS 7 8

Select Data Bits

Any digit key toggles through selections

SET STOP BITS 1 2

Select Stop Bits

Any digit key toggles through selections

SET PARITY NONE ODD EVEN

Select Parity

Any digit key toggles through selections



5-14-3 Manual Mobile-to-Cell Call

NOTE

Pressing any key on the FM/AM-1200S Keyboard (18) in the first column (e.g., "DTMF", "TONE", "OFF-SET", "RF") or sixth row ("2ND FUNCT", "PROG", "EXEC", "ENTER") except when shown in this procedure will terminate the Cellular Test procedure at that point.

Perform a Mobile-to-Cell Call by utilizing the following procedure:

STEP PROCEDURE

1. Press:   

The VFD Display (37) indicates:

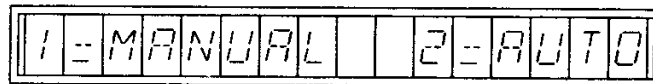

The FM/AM-1200S/A will perform either of these two tests on the Cellular Telephone unit according to the digit selected.

2. Press: 

The VFD Display (37) indicates:

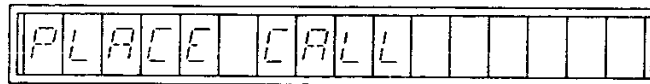

These words will be flashing

3. Press: 

The VFD displays:

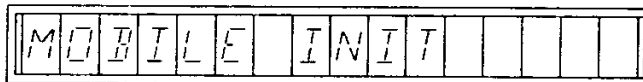

After a short pause, the VFD will display a non-flashing:

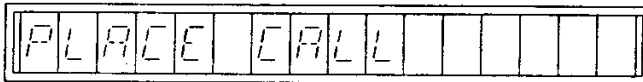

4. On the UUT's keypad, enter the number to be called. When the UUT "No Service" light goes out (as indicated on the the UUT's callouts), press the "SEND" button (or its equivalent) on the UUT.

After the UUT responds, the FM/AM-1200S will display the called number on the VFD:

```

||CALL||CCCCCCCCCCCC
  
```

(with "CCCCCCCCCCCC" the number called)

NOTE

As many as 16 digits may be entered as the number called on most mobile units, although only 11 digits will display on the VFD. However, if fewer than 11 digits are entered, that number of digits will be displayed on the VFD. If no digits are entered on the UUT but the "SEND" is activated anyway, the VFD will display the word "CALL" and the remainder of the VFD screen will be blank. If more than 16 digits are entered on the UUT keypad, the test results will be invalid.

If the "PLACE CALL" phase is successful and the mobile UUT is connected with the simulated cell site (the FM/AM-1200S), the following message will be displayed on the VFD:

```

||MOBILE||CONNECTED||
  
```

After a brief pause, the display will change to:

```

||HXXXX||PL=0||SAT=X||
  
```

This information represents:

HXXXX - "XXXX" is the Voice Channel Number programmed into the FM/AM-1200S during initial programming.

PL=0 - The output Power Level number of the UUT

SAT=X - Is the SAT frequency entered during initial programming. This figure will be:

SAT=0 - 5970 Hz

SAT=1 - 6000 Hz

SAT=2 - 6030 Hz



To adjust the value in the PL= field, press LEFT Arrow key until cursor is over the 0 in the PL= field.

- 4a. Press   to activate the Cellular Power Measurement Function.

The up/down arrows increase or decrease power levels from 0 to 7. Down arrow increases power level and Up arrow will decrease power level.

Press  to return to the original test and HANDOFF, PL= and SAT= prompts.

5. The FM/AM-1200S's VFD cursor position on the above display should be at the "X" of "SAT=X".



Press the  or  key to change the SAT frequency.

NOTE

Changing the "SAT=" frequency during this test will also change the programmed SAT parameter of the FM/AM-1200S.



Use care when changing the SAT frequency. Too rapid switching between frequencies may cause the FM/AM-1200S to lose the SAT and terminate the test.

6. Press the  key once to bring the cursor to the "0" of the "PL=0" segment of the VFD display.

7. Use the  or  keys to scroll through the Power Levels of the UUT from PL=0 (the highest power output) through PL=7 (the lowest power output).

While scrolling through the Power Levels, the CRT Display (31) should be observed. As each Power Level is set in turn, the CRT display should decrease or increase in amplitude as the Power Level decreases or increases.

8. Press the  key to bring the cursor to the "HXXXX" position of the VFD readout.

9. Begin a manual Handoff Test by pressing the  or  key.



As the FM/AM-1200S begins the Handoff Test, the VFD (18) will momentarily display:

H	A	N	D	O	F	F		T	O		H	H	H	H
---	---	---	---	---	---	---	--	---	---	--	---	---	---	---

with "HHHH" the Handoff channel number, then return to:

H	X	X	X	X		P	L	=	0		S	A	T	=	X
---	---	---	---	---	--	---	---	---	---	--	---	---	---	---	---



However, the "HXXXX" will now indicate the new (handed off) Channel number.

By continuing to press the  or  keys, the UUT will continue to handoff until the programmed "HANDOFF END" number (if handing off to a higher channel number) or the "HANDOFF BEG" number (if handing off to a lower channel number) is reached or exceeded. At that point, the UUT will handoff from the "HANDOFF BEG" or "HANDOFF END" channel according to the programmed "HANDOFF INC" number.

NOTE

Performing a Handoff Test in the Manual Test Mode will not change the programmed Voice Channel Number of the FM/AM-1200S.

A Handoff Test to a specific channel may also be performed by entering the desired channel number on the FM/AM-1200S keyboard (18). Channel numbers may be entered and edited in the normal manner. The "HXXXX" segment of the VFD (18) will change to

reflect the entered Channel Number. When the  or  key is pressed, the UUT will handoff to the new channel.

NOTE

If an unused channel number is entered as a handoff channel or an attempt is made to handoff to an unassigned channel number using the programmed "HANDOFF INC" figure, the VFD will momentarily indicate that channel number as a Handoff Channel. However, without the proper information returned to the UUT, the FM/AM-1200S will terminate the Cellular Test. The VFD will then display:

A VFD display showing the text "LOST SAT TONE" in a monospaced font. The text is contained within a rectangular border with a double-line inner border. The characters are spaced out across the display.

as the Cellular Test is terminated, or the VFD may immediately display:

A VFD display showing the text "CALL ENDED" in a monospaced font. The text is contained within a rectangular border with a double-line inner border. The characters are spaced out across the display.

NOTE

Valid Cellular AMPS and ETACS Channel Number and associated Transmit and Receive Frequencies are listed in Appendices G and H.

Cellular transmit and receive channels may also be set directly from the FM/AM-1200S keyboard and

displayed on the VFD (37) by pressing:

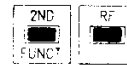

The VFD shows:

A VFD display showing the text "RX CHAN = XXXX" in a monospaced font. The text is contained within a rectangular border with a double-line inner border. The characters are spaced out across the display.

or:

A VFD display showing the text "TX CHAN = XXXX" in a monospaced font. The text is contained within a rectangular border with a double-line inner border. The characters are spaced out across the display.

If necessary, press  to toggle between these two screens.

Use the FM/AM-1200S Keyboard (18) to enter the desired Transmit or Receive Channel number.

5-14-4 Meter Displays During Cellular Testing

Readouts on the MODULATION Meter (1) will display according to the Modulation METER Control (4) setting and on the FREQ ERROR Meter (36) according to the FREQ ERROR Meter Range Selector Control (35), including:

1. With the Modulation METER Control (4) set to 2 KHz/%x10 or 6 KHz/%x10, the MODULATION Meter (1) displays the SAT Deviation.
2. With the Modulation METER Control (4) set to 20 KHz/%x10 or 60 KHz/%x10, the MODULATION Meter (1) displays Signal Tone Deviation.
3. With the FREQ ERROR Meter Range Selector Control (35) at any RF setting, the FREQ ERROR Meter (36) shows the UUT transmitter frequency error.
4. With the FREQ ERROR Meter Range Selector Control (35) set to any AUDIO setting, the FREQ ERROR Meter (36) will show the UUT SAT and FM/AM-1200S SAT frequency difference.

NOTE

It may be necessary to mute the UUT microphone for a stable Audio Frequency Error reading.

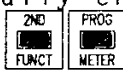
5. Frequency Error and Deviation levels may be digitally checked and displayed on the VFD during the test by pressing: 

With the Modulation METER Control (4) set to any kHz/%x10 position, the VFD will display:



By rotating the Modulation METER Control (4), the VFD will continue to display Frequency Error (FE) plus, as the second VFD readout:

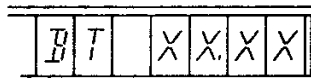

Battery Charge Level

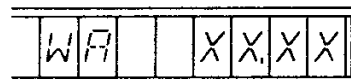
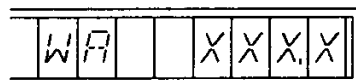

Watts Average

STEP

PROCEDURE



Watts Peak (WP)

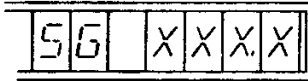

Signal Level

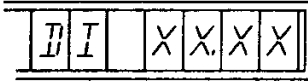

Distortion Level (DI)

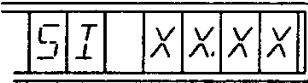

SINAD (SI)

NOTE

The SINAD displayed on the VFD using the above method will always be "01.00". To perform a SINAD test in the Manual Mode, complete procedure 5-14-5.

6. To return to the Cellular test procedures, press:



5-14-5 Manual Cellular Test SINAD Measurement

To measure the SINAD of the UUT while in the manual Cellular Test, complete the following steps:

STEP

PROCEDURE

1. Complete Procedures 5-14-2 thru 5-14-4 as applicable.
2. Connect the Audio Signal Output of the UUT to the EXT MOD/SINAD Connector (15) of the FM/AM-1200S.



NOTE

The SINAD Meter has a range of 3 dB to 20 dB at 1 kHz, an accuracy of ± 1 dB at 12 dB SINAD and an Input Level of 0.25 VRMS to 2 VRMS (10 VRMS Maximum).

3. Place Modulation METER Control (4) to SINAD. The MODULATION Meter (1) will go to full deflection.

STEP

PROCEDURE

4. Press:   to enable SINAD.
5. Set 1 kHz Tone Selector Switch (7) to the "INTL" position.
6. Adjust the RF Level Attenuator Vernier Control (10) and the RF Level Attenuator Control (9) to obtain the desired reading on the SINAD scale.
7. Set 1 kHz Tone Selector Switch (7) to "OFF" position.
8. Disconnect Audio Signal Output from EXT MOD/SINAD Connector (15).
9. To return to the Cell Test procedure, press: 

5-14-6 Check DTMF Digits During Manual Cellular Test



To check DTMF Digits while performing a Manual Cellular Test, complete the following steps:

STEP

PROCEDURE

NOTE

DTMF Decode (Option 10) must be installed to check the UUT handset DTMF.

1. Complete Procedures 5-14-2 thru 5-14-5 as applicable.
2. Press: 
3. Use UUT keypad to enter DTMF digits. Entered DTMF digits will display on the VFD.
4. To return to the Cell Test procedure, press: 

5-14-6a Flash Hook Test

Complete the Flash Hook Test by the following steps:

STEP	PROCEDURE
------	-----------

1. Complete procedures 5-14-2 thru 5-14-6 as applicable.
2. Press the "SEND" button (or its equivalent) on the UUT. UUT will respond with a 400 msec Signal Tone and



will appear on the VFD (37).

3. To return to the Cell Test procedure, press: 

5-14-7 Check Voice Deviation During Manual Cellular Test

To check Voice Deviation during a Manual Cellular Test, complete the following steps:

STEP	PROCEDURE
------	-----------

1. Complete Procedures 5-14-2 thru 5-14-6a as applicable.
2. Turn Scope Vertical Control (24) to 5 KHz/%x10.
3. Turn HORIZONTAL Sweep Selector Control (26) to 1 ms/DIV.
4. Place 1 KHz TONE GENERATOR Switch (7) to SPKR.
5. Turn VOLUME Control fully CCW.

NOTE

Unmute UUT Mic if not already unmuted.

6. Hold UUT Handset close to the FM/AM-1200S speaker and turn the 1KHz TONE GENERATOR Tone Level Control (8) cw and read the deviation on the oscilloscope CRT display (31).

NOTE

The SAT deviation is also present in this reading.

Low level feedback may occur when the UUT Handset is held very close to the FM/AM-1200S Speaker.

5-14-8 Terminating Manual Cellular Test





After performing all necessary tests in the Manual Test Mode, press the "END" button or  on the Keyboard (18). The VFD will then display:



NOTE

Pressing any key, while testing, will interrupt the test and the UUT will remain locked in the current step.



If any of the preceding Manual Cellular Test Procedure steps fail to occur, the test has failed. To

retry the tests, press:    

5-14-9 Manual Cell-to-Mobile Call and Auto Handoff Test

Perform a Manual Cell-to-Mobile Call and Auto Handoff Test by utilizing the following steps:

STEP _____ PROCEDURE _____

1. Press:   

The following message appears on the VFD:



2. Press: 

The following flashing message will appear:

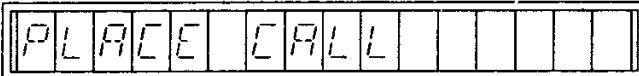

3. Press: 

The following flashing message will appear:

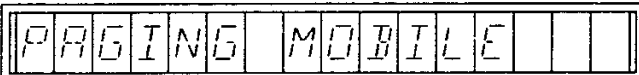

4. Press: 

The following message will appear:



The Cell-to-Mobile Test sequence will start by the simulated cell site (the FM/AM-1200S) performing a Registration Order. While this is performed, the VFD will display:

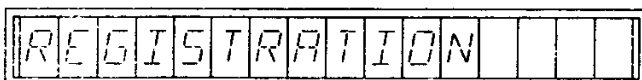

as the FM/AM-1200S begins a registration order. If the mobile UUT responds successfully, the Mobile ID Number (MIN) will be displayed on the VFD, followed by the "P" flag:

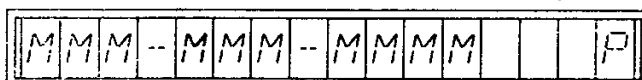

(With "MMMMMMMM" the MIN number)

NOTE

If the mobile UUT fails to respond to the registration order,

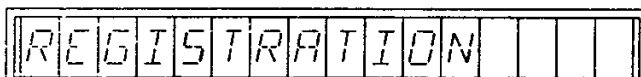

will continue to display but nothing else will occur. To re-institute the test, press:

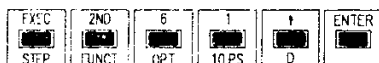
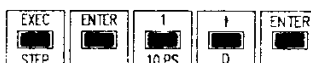
 or 

After registration, the FM/AM-1200S will begin the cell-to-mobile call as the VFD displays:



if the page is successful, the following will shortly appear:

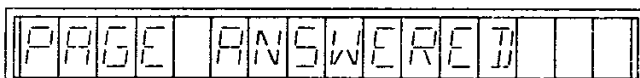

STEP

PROCEDURE

5. The mobile UUT will now begin to ring. Complete the connection by lifting the mobile receiver or pressing the "SEND" button (or equivalent) on the UUT.

If this phase is successful, the following will appear on the VFD:

```
MOBILE CONNECTED
```

NOTE

If, during programming of the FM/AM-1200S,

```
HANDOFF ENABLE 1
```

was selected, go on to Step 6 from this point.

If, during programming of the FM/AM-1200S,

```
HANDOFF ENABLE 0
```

was selected, the following screen will appear shortly after "MOBILE CONNECTED" is displayed:

```
HXXXX PL=0 SAT=X
```

NOTE

The SAT Frequency may be changed, the Power Levels may be checked and a Manual Handoff Test may be performed from the "HXXX PL=0 SAT=X" screen by using the procedures outlined in Paragraph 5-14-3, Manual Mobile-to-Cell Call Test, steps 5 through 9. Frequency Error and Meter readings, Manual SINAD Test, Check DTMF Digits, Voice Deviation Check and Flash Hook Test may also be made at this time by utilizing the appropriate procedures; 5-14-4 thru 5-14-8.

NOTE

If any steps of procedures 5-14-3 thru 5-14-9 fail to occur, the test has failed. To retry, press:



Check DTMF Digits, Voice Deviation Check and Flash Hook Test may also be made at this time by utilizing the appropriate procedures; 5-14-4 thru 5-14-8.

NOTE

If any steps of procedures 5-14-3 thru 5-14-9 fail to occur, the test has failed. To retry, press:

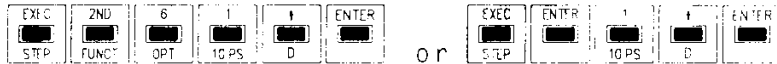

6. Auto Handoff Test

The FM/AM-1200S will now automatically begin a handoff sequence by using the programmed "HANDOFF BEG," "HANDOFF END," "HANDOFF INC" and "HANDOFF RATE" values while the VFD displays:

H A N D O F F T O H H H H

with "HHHH" the current handoff channel. Additional handoffs will display on the VFD according to the "Handoff Begin", "Handoff Increment" and "Handoff End" programmed into the FM/AM-1200S.

7. If the mobile unit successfully completes all handoff sequences, the VFD will briefly display:

M O B I L E C O N N E C T E D

This will shortly be followed by a brief display of:

H A N D O F F T E S T P

This will be followed by:



H X X X X P L = 0 S A T = X

NOTE

The SAT Frequency may be changed, the Power Levels may be checked and a Manual Handoff Test may be performed from the "HXXX PL=0 SAT=X" screen by using the procedures outlined in Paragraph 5-14-3, Manual Mobile-to-Cell Call Test, steps 5 through 9.

NOTE

Frequency Error and Meter readings, a Manual SINAD Test, a Check of DTMF Digits, a Voice Deviation Check and a Flash Hook Test may also be made at this time by utilizing the appropriate procedures; 5-14-4 thru 5-14-8.

7A. Press   to activate the Cellular Power Measurement Function.

The up/down arrows increase or decrease power levels from 0 to 7. Down arrow increases power level and Up arrow decreases power level.











Press  to return to the original test and HANDOFF, PL= and SAT= prompts.

NOTE

If an Auto Handoff to any programmed channel fails, the test will stop at that point and the VFD will display:

CELL INIT F

To repeat the test, press:

      or     

5-14-10 Supervisory Audio Tone (SAT) Measurement

The SAT output of the UUT may be measured by utilizing the following procedure:

STEP _____ PROCEDURE _____

NOTE

The UUT and the FM/AM-1200S must be programmed to the same Channel Number to perform the SAT Measurement. Set the UUT for output on the Voice Channel programmed for the FM/AM-1200S.

1. Connect UUT Output to T/R Connector (11).
2. Turn MODE Selector Control (39) to "REC".
3. Using Keyboard (18), enter the desired Voice Channel Number or Mobile Transmit Frequency (For the Transmit Frequency of the programmed Voice Channel, Ref. Appendix G for AMPS units or Appendix H for ETACS units).

For example, if the programmed Voice Channel is #334, perform either steps a thru c or steps d thru e.

- a. Press:  

One of the following screens will appear:



or



- b. If necessary, press:  to obtain the " RX CHAN=" (Mobile Receive Channel) Screen.

c. Press:    

The VFD indicates:

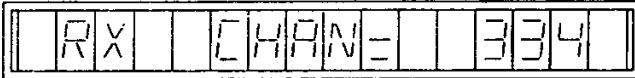

As an alternative method:

d. Press: 

The VFD indicates:



Using the FM/AM-1200S Keyboard (18), enter "835.020" (The Mobile Transmit/Cell Site Receive frequency for Channel #334) as the Receive RF.

e. Press:        

The VFD indicates:

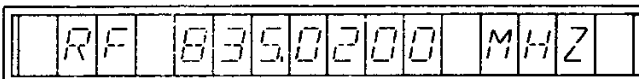

NOTE

For ETACS cellular units, use 898.3375 MHz as the Mobile Transmit/Cell Site Receive frequency and

press:         

The VFD indicates:

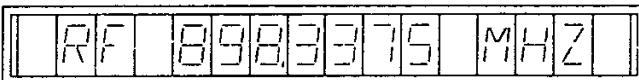

STEP

PROCEDURE

4. Utilize the manual test instructions for the UUT for output of the SAT from the unit's T/R connector or antenna.
 - a. Turn on UUT transmitter.
 - b. Turn on UUT SAT.
 - c. Program UUT to desired Voice Channel.

5. On the FM/AM-1200S front panel, press:

EXEC STEP	2ND FUNCT	6 OPT
--------------	--------------	----------

The VFD indicates:



6. Press:

1 TOPS

The VFD will display the flashing message:



7. Press the:

1 D

 key twice or until the VFD displays a flashing:

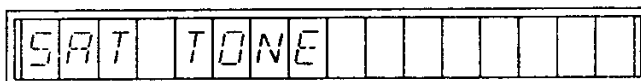

8. Press:

ENTER

The VFD will stop flashing and the SAT will display on the MODULATION METER (1) with the Modulation METER Control (4) set to the 2 kHz/%x10 or 6 kHz/%x10 setting.

9. To digitally display the SAT, press:

2ND FUNCT	PROG METER
--------------	---------------

The SAT will display on the VFD as:

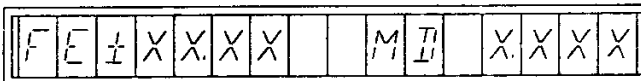

with the "MD X.XXX" as the SAT in kHz.

10. To exit the test, press:

RF

5-14-11 Signal Tone Measurement



The Signal Tone output of the UUT may be measured by utilizing the following procedure:

STEP _____ PROCEDURE _____

NOTE

The UUT and the FM/AM-1200S must be programmed to the same Channel Number to perform the ST Measurement. Set the UUT for output on the Voice Channel programmed for the FM/AM-1200S.

1. Connect UUT to T/R Connector (11)
2. Turn MODE Selector Control (39) to "REC".
3. Using Keyboard (18), enter the desired Voice Channel Number or Mobile Transmit/Cell Site Receive Frequency (For the Transmit Frequency of the programmed Voice Channel, Ref. Appendix G for AMPS units or Appendix H for ETACS units).

As an alternative method, press:  

Use the  key, if necessary, until the VFD displays:

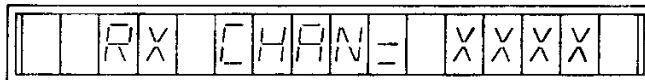

4. Utilize the manual test instructions for the UUT for output of the ST from the unit's T/R connector or antenna.
 - a. Turn on UUT transmitter.
 - b. Turn on UUT ST.
 - c. Program UUT to desired Voice Channel.

5. On the FM/AM-1200S front panel, press:   

The VFD indicates:





STEP

PROCEDURE

6. Press: 

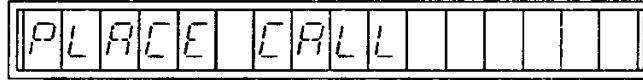
The VFD will display the flashing message:





7. Press the  key three times or until the VFD displays the flashing message:



8. Press: 

The VFD will stop flashing and the Signal Tone will display on the MODULATION METER (1) with the Modulation METER Control (4) set to the 20 kHz/%x10 or 60 kHz/%x10 setting.

9. To digitally display the Signal Tone, press:  

The Signal Tone will display on the VFD as:

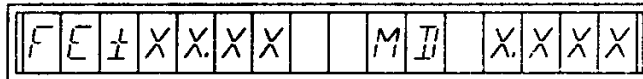

with the "MD X.XXX" as the Signal Tone in kHz.

10. To exit the test, press: 

5-14-12 Manual UUT Registration

The Registration output of the UUT may be decoded by utilizing the following procedure:

STEP

PROCEDURE

1. Output the UUT's Registration from its T/R connector or antenna.

2. On the FM/AM-1200S front panel, press:   

The VFD reads:

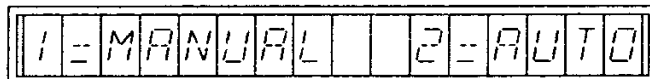

3. Press: 

4. Press the  key four times or until the VFD shows a flashing:

REGISTRATION

5. Press: 

The VFD message will stop flashing and the UUT will output a registration message. When it is received, the VFD will display:

MIN MMM-MMM-MMMM

With "MMMMMMMM" as the Mobile ID Number.

NOTE

If, during programming of the FM/AM-1200S,

PRINT ENABLE = 1

was selected, the first section of the Cellular Test Printout will be printed (ref. Figure 5-9a). This information may be used as information for further testing or as an incoming UUT record.

```

***** IFR FM/AM 1200S AMPS CELLULAR MOBILE AUTO TEST *****
* NAME _____ DATE _____ *
* MOBILE I.D. NUMBER - 3165224981 USER ID# 123 *
* MOBILE SERIAL NUMBER - 12900006652 HEX: 810019FC OCT: 20100014774 *
* HOME ID - 00020 SCM - 00 SAT - 5970 HZ DCC - 0 [HOME] *
* POWER CLASS I CONTINUOUS BANDWIDTH = 20 MHZ *

```

Figure 5-9a Manual UUT Registration Printout (AMPS)

5-14-13 No-Coax Mobile-to-Cell Call

To make a Mobile-to-Cell Call with no coax connection, utilize the following steps:



NOTE

To avoid interference with nearby transmitters/receivers, perform the No-Coax Call Procedures in an RF-Screened facility.

STEP **PROCEDURE**

1. Set the FM/AM-1200S Front Panel Controls to the settings as listed in Table 5-12.
2. Install antenna on DUPLEX Output Connector (14).
3. Install antenna on ANT Connector (34).

4. On the FM/AM-1200S front panel, press:  

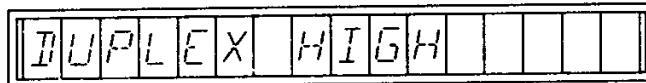

5. Press the  or  key until the VFD shows:

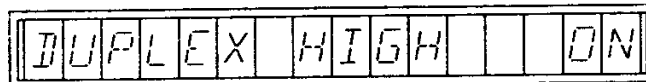

6. Press: 

The VFD shows:



7. Press:   

8. Program the FM/AM-1200S to the parameters of the UUT as shown in Paragraph 5-14-2, Step 10.

9. Press:   

The VFD shows:

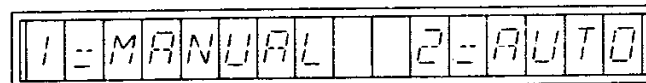

STEP

PROCEDURE

10. Press: 

The VFD indicates a flashing:

PLACE CALL

11. Press the  key five times or until the VFD shows a flashing:

NO COAX CALL

12. Press: 

As the cell site (the FM/AM-1200S) begins the call procedure, the VFD shows:

MOBILE INIT

13. Turn the Mobile unit power on. The FM/AM-1200S will "capture" the mobile unit and the mobile unit's "NO SERVICE" readout (or its equivalent) should go out or its "ROAM" indicator should illuminate.
14. Place a call as outlined in paragraph 5-14-3, Step 4 and continue with the applicable Manual Mobile-to-Cell Call procedures, including the remaining steps of 5-14-3 and paragraphs 5-14-4 and 5-14-6 thru 5-14-8.

5-14-14 No-Coax Cell-to-Mobile Call

To make a Cell-to-Mobile Call with no coax connection, utilize the following steps:

STEP PROCEDURE



NOTE

To avoid interference with nearby transmitters/receivers, perform the No-Coax Call Procedures in an RF-Screened facility.

1. Set the FM/AM-1200S Front Panel Controls to the settings as listed in Table 5-12.
2. Install antenna on DUPLEX Output Connector (14).
3. Install antenna on ANT Connector (34).

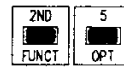
4. On the FM/AM-1200S front panel, press:



5. Press the  or  keys until the VFD displays:

DUPLEX HIGH

6. Press:



The VFD reads:

DUPLEX HIGH ON

7. Press:



8. If necessary, program the FM/AM-1200S to the parameters of the UUT as shown in Paragraph 5-14-2, Step 10.

9. Press:



The VFD shows:

1=MANUAL 2=AUTO

10. Press:



STEP

PROCEDURE

11. Press the  key six times or until the VFD indicates:

NO COAX PAGE

12. Press:



The cell site (the FM/AM-1200S) begins paging as the VFD shows:

MOBILE INIT

13. Turn the mobile unit power on. The FM/AM-1200S will begin a mobile unit Registration as the VFD shows:

REGISTRATION

14. Continue with a Manual Cell-to-Mobile Call and Auto Handoff Test as shown in 5-14-9, Step 3 and on. Procedures 5-14-4 and 5-14-6 thru 5-14-7 may also be performed.

5-14-15 Cellular Auto Test Procedure

When the Auto Test is selected, Mobile-to-Cell Call, the Cell-to-Mobile Call, the measurement of eight transmit power levels for the UUT and the Handoff Tests will be performed sequentially.

Do not turn RTD=ON when utilizing GPIB/RS-232.

To perform the Auto Test, complete the following steps:

STEP

PROCEDURE

1. Press:   
The VFD will display:

REGISTRATION

2. Press:



3. The FM/AM-1200S will perform these tests and measurements:

Mobile-to-Cell Call
SINAD Test (if enabled)
Cell-to-Mobile Call
Power Level 0 through 7 Measurement
Handoff Test (if enabled)
Supervisory Audio Tone (SAT) Measurement
Signal Tone (ST) Measurement

The following screens appear sequentially on the VFD:

```

AUTO TEST
REGISTRATION
  
```

NOTE

If the Registration is unsuccessful, an "F" will appear on the VFD:

```

REGISTRATION F
  
```

but the FM/AM-1200S will continue the Auto Test with the programmed MIN.

4. When the

```

PLACE CALL
  
```

screen appears and the handset's "No Service" callout or its equivalent goes out, press the "SEND" button on the UUT to place a call from the Mobile Unit to the Cell Site (the FM/AM-1200S).

The following screens will then appear as the Auto Test continues:

```

CALL CCCCCCCCCCCCCC
  
```

(With "CCCCCCCCCCCC" the number called)

```

MOBILE CONNECTED
  
```

NOTE

If during programming:

```

SINAD ENABLE = 1
  
```

was programmed, proceed with Step 5.

NOTE

If:

S	I	N	A	D	E	N	A	B	L	E	=	0
---	---	---	---	---	---	---	---	---	---	---	---	---

was programmed, the call will end. Proceed to Step 14.

5. After the Mobile unit has been called, the following screen will appear on the VFD:

X	X	D	B	S	I	N	A	D	=	X	X	X
---	---	---	---	---	---	---	---	---	---	---	---	---

On this screen, the "XXDB" indication is the programmed dB Level to be tested. The "= XXX" segment of the screen is the Generate Level of the FM/AM-1200S. The first digit of the "= XXX" will blink, indicating this is the cursor position.

The MODULATION Meter (1) will be at full deflection at this time.

6. Connect the UUT Handset Audio Output to the EXT MOD/SINAD Connector (15) of the FM/AM-1200S.

NOTE

The SINAD Meter has a range of 3 dB to 20 dB at 1 kHz, an accuracy of ± 1 dB at 12 dB SINAD and an Input Level of 0.25 VRMS to 2 VRMS (10 VRMS Maximum).

7. Place the 1 kHz TONE GENERATOR Switch (7) to INTL.
8. Adjust the RF Level Control (9) and RF Level Vernier Control (10) for a SINAD indication on the MODULATION Meter (1) equal to the "XXDB" level displayed on the VFD.

STEP

PROCEDURE

9. Read the RF Level as shown on RF Level Control (9). Enter the RF Level as the "= XXX" figure.

If, for example, the RF Level reading is 108 dBm, press:

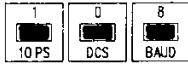
**NOTE**

Do not press  until completing Steps 10 and 11.

10. Place the 1 kHz TONE GENERATOR Switch (7) to OFF.
11. Disconnect UUT Handset Audio Output from the EXT MOD/SINAD Connector (15).

12. Press: 

13. After a brief pause,

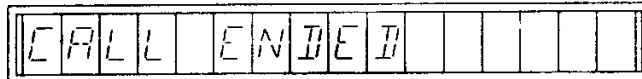

will appear on the VFD. As the Auto Test continues, this will be replaced by:



14. At this point, the mobile unit should begin ringing. Complete the call by lifting the mobile unit's receiver or by pressing the "SEND" button or its equivalent. The following message should appear on the VFD:

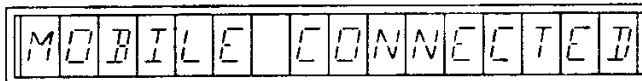

15. The test will then continue with power level checks as the mobile unit decreases power as instructed by the FM/AM-1200S. The following will appear sequentially on the VFD:

PL	=	0	PWR	=	-	-	-	-	-
----	---	---	-----	---	---	---	---	---	---

PL	=	1	PWR	=	-	-	-	-	-
----	---	---	-----	---	---	---	---	---	---

PL	=	2	PWR	=	-	-	-	-	-
----	---	---	-----	---	---	---	---	---	---

PL	=	3	PWR	=	-	-	-	-	-
----	---	---	-----	---	---	---	---	---	---

PL	=	4	PWR	=	-	-	-	-	-
----	---	---	-----	---	---	---	---	---	---

PL	=	5	PWR	=	-	-	-	-	-
----	---	---	-----	---	---	---	---	---	---

PL	=	6	PWR	=	-	-	-	-	-
----	---	---	-----	---	---	---	---	---	---

PL	=	7	PWR	=	-	-	-	-	-
----	---	---	-----	---	---	---	---	---	---

The “- - - - -” in each power level check screen will be replaced after a short pause with the RF power level readings of the mobile unit output.

NOTE

Observe the screens and power meter as each power level is read. Each successive reading should be less than the preceding one. This power reduction may also be observed on the MODULATION Meter (1) and the Spectrum Analyzer CRT display (31).

16. The test will continue from this point with a Handoff Test as the VFD displays:

HANDOFF TO HHHH

with "HHHH" the current handoff channel. Additional handoffs will display on the VFD according to the "HANDOFF BEG", "HANDOFF INC" and "HANDOFF END" numbers programmed into the FM/AM-1200S (if the HANDOFF Test is enabled).

After the Handoff Test is completed successfully, the following will appear on the VFD:

HANDOFF TEST P

NOTE

During most tests in the "AUTO" Test Mode, if the desired screen fails to appear, appears with an

F

or if

MOBILE INIT F

appears, the test will continue. However, when the test results are read after the test ends,

TEST RESULT F

will appear (See procedure 5-14-7).

But, if the UUT fails the Handoff Test,

CELL INIT F

will appear and the test will stop at that point.

To retry the test, press:



17. After the Auto Test is finished, the VFD will display:

TEST RESULT P F

5-14-16 Error Messages

While performing a Cellular Mobile Unit Test, a number of error messages may appear on the VFD screen of the FM/AM-1200S. A list of these error messages, their meanings and some suggested remedies are:

SYNCR NOT ACQ'D

The FM/AM-1200S was unable to acquire a word sync after 10 successive attempts. The FM/AM-1200S will continue to page the mobile unit. Check setting of SQUELCH Control (41).

INCORRECT DCC

The Digital Color Code (DCC) received from the mobile unit did not match the one sent. The FM/AM-1200S will continue to page the mobile unit.

RECEIVE TIMEOUT

The UUT did not respond with correct information within a set time frame or after a certain number of data inquiries by the FM/AM-1200S.

LOST SAT TONE

The Supervisory Audio Tone (SAT) was lost during the test. Check setting of SQUELCH Control (41).



LOCAL SAT ERROR



FM/AM-1200S is not set to within specifications of:
2 kHz deviation (± 200 Hz) for AMPS.
1.70 kHz deviation (± 200 Hz) for E-TACS.

5-14-17 Test Results Review

A. Manual Test Results Review

When a cellular unit test is complete, stored test information

is accessed by pressing:   This presents a list of test

results on the VFD which is reviewed by pressing  or .

The manual test result review screens include:



Test Result



SAT Deviation Reading in kHz 0-9.999

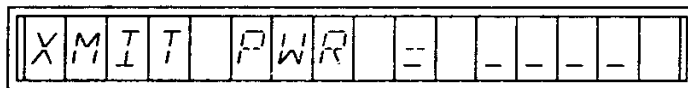

RF Transmit Power of Mobile Unit's (milliwatts) 0-9999.9

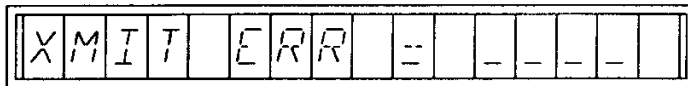

Frequency Error of Mobile's Transmitter (kHz) 0000 (w/decimal)



Signaling Tone Deviation (kHz) 0-99.99

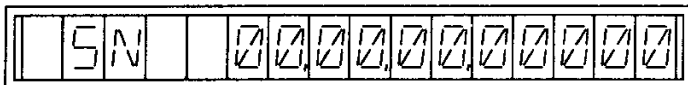

Programmed UUT Serial Number (TACS or ETACS Format)

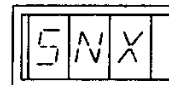
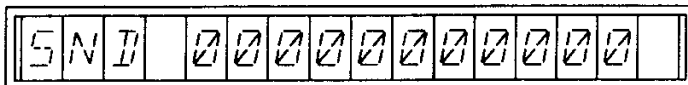

Programmed UUT Serial Number (AMPS Format)

NOTE

The UUT Serial Number will display as programmed; e.g., if "SNX" was programmed, "SNX" will display.

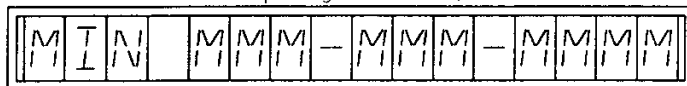

Programmed UUT Mobile ID Number

B. Test Printout

When

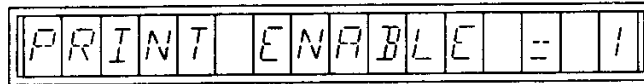

is selected during programming of the FM/AM-1200S for a Cellular Test, the results of the Auto Test will be directed to the printer output pins of the RS-232 connector and a print-out of the test results may be made.

Figure 5-10 shows a typical test printout form for AMPS Cellular Testing (Option 15) and Figure 5-11 shows a typical test printout form for ETACS Cellular Testing (Option 16).

```

***** IFR FM/AM 1200S AMPS CELLULAR MOBILE AUTO TEST *****
* NAME _____ DATE _____ *
* MOBILE I.D. NUMBER - 2340729457 USER ID# 000 *
* MOBILE SERIAL NUMBER - 13000645849 HEX: 8209DAD9 OCT: 20202355331 *
* HOME ID - 00020 SCM - 01010 SAT - 5970 HZ DCC - 0 [HOME] *
* POWER CLASS III CONTINUOUS BANDWIDTH = 25 MHZ *
***** MOBILE INITIATED CALL*****
* CALLED NUMBER 123 *
* CHANNEL = 1023 825.0000/870.0000 MHZ *
* FREQ. ERROR +0.295 KHZ *
* DEVIATION 1.960 KHZ SAT ONLY *
* TRANSMITTER POWER 793.1 mW *
* HANGUP DEVIATION 09.46 KHZ ST + SAT *
***** 12 dB SINAD TEST *****
* ATTENUATOR READING = -116 dBM -OR- 0.3 uV *
***** POWER LEVEL TEST *****
* LEVEL POWER READING PASS/FAIL *
* 0 797.5 mW F *
* 1 801.8 mW F *
* 2 801.8 mW F *
* 3 358.5 mW F *
* 4 167.0 mW F *
* 5 56.7 mW F *
* 6 24.2 mW F *
* 7 9.9 mW P *
***** HAND-OFF TEST *****
* CHANNEL = 222 831.6600/876.6600 MHZ *
* FREQ. ERROR +0.292 KHZ *
* DEVIATION 1.956 KHZ SAT ONLY *
* TRANSMITTER POWER 876.8 mW *
***** CELL INITIATED CALL *****
* CHANNEL = 1023 825.0000/870.0000 MHZ *
* FREQ. ERROR +0.296 KHZ *
* DEVIATION 1.970 KHZ SAT ONLY *
* TRANSMITTER POWER 797.5 mW *
* RING DEVIATION 09.54 KHZ ST + SAT *
* HANGUP DEVIATION 09.42 KHZ ST + SAT *
*****

```

Figure 5-10 AMPS Cellular Test Printout Form

```

***** IFR FM/AM 1200S E-TACS CELLULAR MOBILE AUTO TEST *****
* NAME _____ DATE _____
* MOBILE I.D. NUMBER - 2340729457 USER ID# 000
* MOBILE SERIAL NUMBER - 03/05/00/08081 HEX: 1F910143 OCT: 03744200503
* HOME ID - 02051 SCM - 00001 SAT - 5970 HZ DCC - 0 [HOME]
* POWER CLASS 2 CONTINUOUS EQUIPPED FOR 1000 CHANNELS
***** MOBILE INITIATED CALL *****
* CALLED NUMBER 123
* CHANNEL = 333 898.3125/943.3125 MHZ
* FREQ. ERROR -0.245 KHZ
* DEVIATION 1.338 KHZ SAT ONLY
* TRANSMITTER POWER 2125.0 mW
* HANGUP DEVIATION 08.12 KHZ ST + SAT
***** 12 dB SINAD TEST *****
* ATTENUATOR READING = -116 dBM -OR- 0.3 uV
***** POWER LEVEL TEST *****
* LEVEL POWER READING PASS/FAIL
+ 0 2132.0 mW F
+ 1 935.9 mW F
+ 2 367.7 mW F
+ 3 142.7 mW F
+ 4 58.3 mW F
+ 5 23.6 mW F
+ 6 9.0 mW F
+ 7 4.0 mW P
***** HAND-OFF TEST *****
* CHANNEL = 222 895.5375/940.5375 MHZ
* FREQ. ERROR -0.204 KHZ
* DEVIATION 1.366 KHZ SAT ONLY
* TRANSMITTER POWER 2220.0 mW
***** CELL INITIATED CALL *****
* CHANNEL = 1023 898.3125/943.3125 MHZ
* FREQ. ERROR -0.203 KHZ
* DEVIATION 1.360 KHZ SAT ONLY
* TRANSMITTER POWER 2132.0 mW
* RING DEVIATION 08.06 KHZ ST + SAT
* HANGUP DEVIATION 08.06 KHZ ST + SAT
*****

```

Figure 5-11 ETACS Cellular Test Printout Form

5-14-18 RS-232 REMOTE CELLULAR COMMANDS

REMOTE COMMANDS	DESCRIPTION	RANGE OF VALUES
CNTCHN=	Set Control Channel	1 - 1023 AMPS, ETACS*
CNTCHN?	Return Control Channel	1 - 1023 AMPS, ETACS*
HOMROM=	Set HOME/ROAM Select	"HOME" , "ROAM"
HOMROM?	Return HOME/ROAM Select	"HOME" , "ROAM"
VOCCHN=	Set Voice Channel	1 - 1023 AMPS, ETACS*
VOCCHN?	Return Voice Channel	1 - 1023 AMPS, ETACS*
MIN=	Set Mobile I.D. Number	10 decimal digits or "#" , "*"
MIN?	Return Mobile I.D. Number	10 decimal digits or "#" , "*"
SERIAL=	Set Serial Number as Decimal	11 decimal digits
SERNO?	Return Serial Number	8 hexadecimal or 11 octal/decimal digits
SERNOD=	Set Serial Number/Format as Decimal	11 decimal digits
SERNOX=	Set Serial Number/Format as Hexadecimal	8 hexadecimal digits
SERNOO=	Set Serial Number/Format as Octal	11 octal digits
SATFREQ=	Set SAT Frequency Select	5970/6000/6030
SATFREQ?	Return SAT Frequency Select	5970/6000/6030
HOMEID=	Set Home Area I.D. #	5 decimal digits
HOMEID?	Return Home Area I.D. #	5 decimal digits
DCC=	Set Digital Color Code	0, 1, 2
DCC?	Return Digital Color Code	0, 1, 2
HENAB=	Set Handoff Test Enable	0 = Disabled, 1 = Enabled
HENAB?	Return Handoff Test Enable	0 = Disabled, 1 = Enabled
HBEG=	Set Handoff Test Begin #	1 - 1023 AMPS, ETACS*
HBEG?	Return Handoff Test Begin #	1 - 1023 AMPS, ETACS*
HEND=	Set Handoff End Channel	1 - 1023 AMPS, ETACS*
HEND?	Return Handoff End Channel	1 - 1023 AMPS, ETACS*
HINC=	Set Handoff Test Increment	0 - 999
HINC?	Return Handoff Test Increment	0 - 999
HRATE=	Set Handoff Delay Rate	0 - 9 Seconds
HRATE?	Return Handoff Delay Rate	0 - 9 Seconds

Table 5-13 RS-232 Remote Cellular Testing Commands

REMOTE COMMANDS	DESCRIPTION	RANGE OF VALUES
CFMT=	Specify Cellular Format	"AMPS" , "E-TACS"
CFMT?	Return Cellular Format	"AMPS" , "E-TACS"
OPID=	Specify Operator I.D. Number	3 decimal digits
OPID?	Return Operator I.D. Number	3 decimal digits
PENAB=	Set Printer Enable	1 = Enabled 0 = Disabled
PENAB?	Return Printer Enable Status	1 = Enabled 0 = Disabled
PBAUD	Set Printer Baud Rate	0 = 110 4 = 2400 1 = 300 5 = 4800 2 = 600 6 = 9600 3 = 1200
PBAUD?	Return Printer Baud Rate	0 = 110 4 = 2400 1 = 300 5 = 4800 2 = 600 6 = 9600 3 = 1200
PDATA=	Set Printer Data Bits	7 or 8
PDATA?	Return Printer Data Bits	7 or 8
PSTOP=	Set Printer Stop Bits	1 or 2
PSTOP?	Return Printer Stop Bits	1 or 2
PPARITY=	Set Printer Parity	0 = None 1 = Odd 2 = Even
PPARITY?	Return Printer Parity	0 = None 1 = Odd 2 = Even
CALLC	Execute Cell-Initiated Call Processing Test	
CALLM	Execute Mobile-Initiated Call Processing Test	
CALLA	Execute Call Processing Test in Auto-Test Mode	
CPRES?	Return Result of Call Processing Test	P = Pass F = Fail
CABORT	Abort Cellular Radio Test	
SATDEV?	Return SAT Tone Deviation Reading	0 - 9999
XPWR?	Return Mobile Transmitter Signal Level	0 - 9999
XERR?	Return Mobile Transmitter Frequency Error	0 - 9999
STDEV?	Return Signal Tone Deviation	0.0 to 9999

ETACS* = E-TACS 0 - 2047 (1001 - 1328 Invalid)

Table 5-13 RS-232 Remote Cellular Testing Commands (Cont.)

11/11/11 11:11:11



APPENDICES

APPENDIX A – FM/AM-1200S/A SPECIFICATIONS

A-1 RF SIGNAL GENERATOR

Frequency Range:	250 kHz to 999.9999 MHz in 100 Hz increments.
Frequency Accuracy:	± 5 Hz + Master Oscillator (S/Ns thru 4490 for FM/AM-1200S, S/Ns thru 1448 for FM/AM-1200A). See Master Oscillator for FM/AM-1200S S/N 4491 and after (S/N 1449 and after for FM/AM-1200A).
Residual FM:	<100 Hz RMS (300 Hz to 3 kHz Bandwidth)
Harmonics:	2nd Harmonic ≤ -30 dBc 3rd Harmonic ≤ -45 dBc
Non-Harmonics & Spurious (at offset from selected frequency):	± 10 kHz to ± 1.5 MHz: ≤ -30 dBc in band ± 1.5 MHz to band end: ≤ -55 dBc (If image ≤ -35 dB)
RF Output Power:	-127 dBm to -20 dBm (10 dB steps with 11 dB range vernier) into 50 ohms.
RF Output Accuracy:	± 2.5 dB (± 3 dB at frequencies >800 MHz and levels between -120 dBm and -127 dBm for FM/AM-1200S thru S/N 7698 and FM/AM-1200A thru S/N 1676).
Variable Generate:	When in the "locked" position, the generator is phased locked to the master oscillator. When switched from the "locked" position, the generator may be varied ± 10 kHz.
Internal Modulation:	
Deviation Range:	0 to 50 kHz (with 1 kHz tone).
% AM Range:	0 to 90% (with 1 kHz tone).
External Modulation:	
Frequency Response:	FM: 2 Hz to 30 Hz (DC when in variable generate) AM: 10 Hz to 10 kHz (30% maximum modulation above 5 kHz).
Modulation Sensitivity:	FM: .1 VRMS/kHz (-0 to +30%) AM: .01 VRMS/% (-0 to +30%)
Distortion (at 1 kHz sine):	FM: <1% to 20 kHz deviation AM: <10% to 60% modulation
Input Impedance:	10K Ohms nominal

A-2 DUPLEX GENERATOR

Frequency Range: ± 49.99 MHz from receive frequency in 10 kHz steps.
Frequency Resolution: 2.5 kHz
Frequency Accuracy: (See Master Oscillator)
Output Level:
 DUPLEX Port: (FM/AM-1200A)
 -60 dBm ± 10 dB fixed level into 50 ohm.
 (FM/AM-1200S)
 DUPLEX HIGH: -15 dBm into 50 ohms ± 10 dB
 DUPLEX LOW: -40 dBm into 50 ohms (-25 dB ± 5 dB below
 DUPLEX HIGH at the same frequency)
 Input Protection: 0.25 WATT (maximum without damage)
 T/R Port: (FM/AM-1200A) -80 dBm ± 10 dB fixed level
 (FM/AM-1200S) -85 dBm ± 10 dB fixed level

A-3 RECEIVE/MONITOR

Frequency Range: 10 kHz to 999.9999 MHz in 100 Hz increments
Sensitivity: $2 \mu\text{V}$ typical (1 MHz to 1000 MHz FM narrow)

Selectivity (at 3 dB):

<u>MODE</u>	<u>RECEIVER</u> <u>BANDWIDTH</u>	<u>AUDIO</u> <u>BANDWIDTH</u>
FM WIDE	200 kHz	80 kHz
FM MID	200 kHz	8 kHz
FM NAR	15 kHz	8 kHz
SSB	6 kHz	8 kHz
AM NAR	6 kHz	8 kHz
AM NORM	15 kHz	8 kHz

Adjacent Channel Rejection:

<u>RECEIVER</u> <u>BANDWIDTH</u>	<u>GREATER THAN</u> <u>40 dB DOWN</u>
200 kHz	± 300 kHz
15 kHz	± 27 kHz
6 kHz	± 15 kHz

Demodulation Output:

Impedence: 600 Ohms
Output Level: (Into an open circuit):
FM: 60 mVRMS/1 kHz (nominal)
AM: 5 mVRMS/% (nominal)

Receiver Antenna

Input Protection: 0.25 WATT (maximum without damage)

A-4 POWER METER

Range: 0 to 15 and 0 to 150 WATTS peak or average responding.

Accuracy: 1 to 600 MHz $\pm 7\%$ of reading of full scale.
600 to 1000 MHz $\pm 20\%$ of reading $\pm 3\%$ of full scale.

Input Power: 50 WATTS continuous
>50 to 150 WATTS, one minute "ON", five minutes "OFF".

A-5 FREQUENCY ERROR METER

RF Accuracy: \pm Master Oscillator
 $\pm 3\%$ of full scale

RF Ranges: ± 10 kHz, ± 3 kHz, ± 1 kHz, ± 300 Hz,
 ± 100 Hz, ± 30 Hz full scale

Audio Counter:

Frequency Range: 10 Hz to 12 kHz

Accuracy: $\pm 0.01\%$ $\pm 3\%$ of full scale

Ranges: ± 300 Hz, ± 30 Hz, ± 3 Hz full scale

A-6 MODULATION METER

FM Deviation:

Accuracy: $\pm 5\%$ of reading,
 $\pm 3\%$ of full scale for a 1 kHz tone.

Ranges: 2 kHz, 6 kHz, 20 kHz, 60 kHz full scale.

AM % Modulation:

Accuracy: $\pm 5\%$ of reading
 $\pm 3\%$ of full scale for a 1 kHz tone

Ranges: 60%, 200% full scale

A-7 SINAD/DISTORTION METER

SINAD: 3 to 20 dB at 1 kHz

Accuracy: ± 1 dB at 12 dB SINAD

Distortion Range: 0 to 20% at 1 kHz

Accuracy: $\pm 1\%$ at 10% distortion

Input Level: 0.25 VRMS to 2 VRMS (10 VRMS maximum)

Impedance: 10K Ohm Nominal

A-8 FUNCTION GENERATOR

Functions:	SINE, SQUARE, RAMP, TRIANGLE, DTMF, TONE SEQ and DCS
Tone Accuracy:	
Fixed:	(Same as Master Oscillator)
Variable:	$\pm 0.01\%$
Tone Distortion:	(At 2.5 VRMS output)
Fixed:	$< 0.5\%$
Variable (SINE):	$< 2\%$ (10 Hz to 100 Hz) $< 0.7\%$ typical (100 Hz to 30 Hz)
Tone Output Level:	Variable to 2.5 VRMS minimum, either tone into 150 Ohm load
Frequency Range:(Variable):	10 Hz to 30 kHz in 0.1 Hz increments
DTMF ENCODE:	
Deviation:	3.5 kHz Fixed (± 500 Hz)
Mark Time:	50 mSec Minimum
Space Time:	50 mSec Minimum
DTMF Decode (Optional):	See Digital Voltmeter

A-9 OSCILLOSCOPE

Display Size:	2 inches X 2.5 inches
Vertical Bandwidth:	DC to 1 MHz (at 3 dB Bandwidth)
External Vertical Input Ranges:	10 mV, 100 mV, 1 V, 10 V per division
Horizontal Sweep Rate:	FM/AM-1200A – 10 mSec, 1 mSec, 100 μ Sec, 10 μ Sec, 1 μ sec per division FM/AM-1200S – 10 mSec, 1 mSec, 100 μ Sec, 10 μ Sec per division

A-10 DIGITAL VOLTMETER/DTMF DECODE (OPTIONAL)

AC Volts:

Frequency Range:	45 Hz to 10 kHz
Voltage Range:	0 to 100 VRMS
Accuracy:	$\pm 10\% \pm 2$ Counts

DC Volts:

Voltage Range:	0 to ± 100 VDC
Accuracy:	$\pm 10\% \pm 2$ Counts

DTMF DECODE:

Deviation:	1 kHz Minimum
Mark Time:	50 mSec Minimum
Space Time:	50 mSec Minimum
Sensitivity:	20 dB FM Quieting

A-11 MASTER OSCILLATOR

Standard TCXO (Thru FM/AM-1200A S/N 1499, thru FM/AM-1200S S/N 5411)

Stability:	0.5 PPM (0.50° C)
Aging:	1 PPM per year

Standard TCXO (FM/AM-1200A S/N 1500 and on, Option 1 thru FM/AM-1200A S/N 1499; FM/AM-1200S S/N 5412 and on, Option 1 thru FM/AM-1200S S/N 5411)

Stability:	0.2 PPM (0.50° C)
Aging:	0.5 PPM per year

Optional Oven Oscillator: (Option 2)

Stability:	0.05 PPM (0.50° C)
Aging:	0.25 PPM per year

A-12 GENERATE AMPLIFIER (OPTIONAL)

Gain: 30 \pm 2 typical, 250 kHz to 1000 MHz

Test Set Output with
Amplifier Installed: Variable to +10 dBm, FM, CW
Variable to +4 dBm, AM

A-13 TRACKING GENERATOR (OPTIONAL)

Frequency Range: 1 MHz to 999.9999 MHz

Output Levels:

TRACK HIGH: -3 dBm (\pm 5 dB)

TRACK MED: -15 dBm (\pm 7 dB)

TRACK LOW: -40 dBm (+5/-10 dB)

Flatness: \pm 1 dB over center 80% of displayed area,
 \pm 5 dB over remaining display.

Tracking Span: 10 kHz to 10 MHz as set by Spectrum Analyzer
scan width.

Output Impedance: 50 ohm nominal.

Spurious: Harmonic and Non-Harmonic are <5 dBc, typically
10 dB. Image (RF+180 MHz) typically 0 dBc.

Dynamic Range: >70 dB

Tracking Range Adjustment: -200 Hz to 1.0 kHz minimum as compared to analyzer
center.

A-14 GENERAL CHARACTERISTICS

Temperature Range: 0 to 50° C

A-15 POWER REQUIREMENTS

Line: 105 to 130/210 to 260 VAC
50 to 400 Hz at 60 WATTS typical.

Ext. DC: 12 to 30 VDC nominal, 3.5 AMPS at 12 V typical,
1.5 AMPS at 28 V typical.

A-16 SPECTRUM ANALYZER (FM/AM-1200S ONLY)

Log Scale: Within ± 2 dB linearity from -30 dBm to -90 dBm indication

Dynamic Range: 70 dB (from display reading of -30 to -100)

Modes:

<u>SCAN WIDTH</u>	<u>BANDWIDTH</u>
1 MHz/DIV	30 kHz
500 kHz/DIV	30 kHz
200 kHz/DIV	30 kHz
100 kHz/DIV	30 kHz
50 kHz/DIV	30 kHz
20 kHz/DIV	3 kHz
10 kHz/DIV	3 kHz
5 kHz/DIV	3 kHz
2 kHz/DIV	300 Hz
1 kHz/DIV	300 Hz

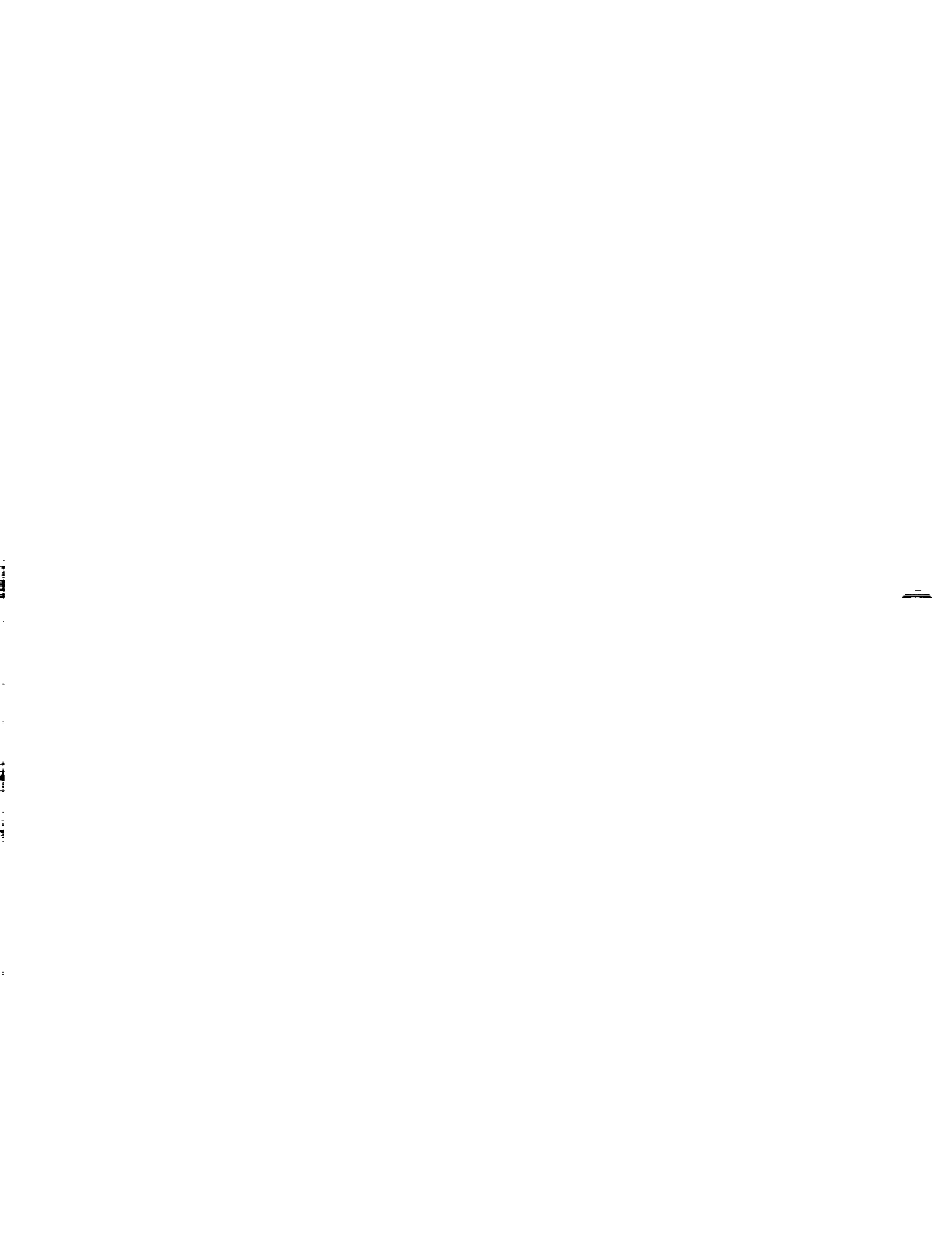

**APPENDIX B – TABLE OF USER I/O PORTS/CONNECTORS
PIN-OUT TABLES**

B-1 TABLE OF I/O PORTS

CONNECTOR NAME	CONNECTOR TYPE	SIGNAL INPUT/OUTPUT	SIGNAL TYPE
T/R (11)	BNC	Input/Output	RF
AUX PWR (12)	Banana Jack	Output	+12 VDC
DUPLEX Output (14)	BNC	Output	RF
EXT MOD/SINAD (15)	BNC	Input/Output	Audio
DEMODO (16)	BNC	Output	Audio
TONE OUT (17)	BNC	Output	Audio
MIC/ACC (19)	5 Pin Microphone Connector	Input/Output	See Pin-Out
SCOPE/DVM (20)	BNC	Input	DC to 1 MHz; AC of DC
ANT (34)	BNC	Input	RF
RS-232 (43)	25 Pin, Type D	Input/Output	See Pin-Out
GPIB – Option 13 (43)	24 Pin GPIB Adapter	Input/Output	See Pin-Out
AC Power (44)	EAC-301	Input	105-130/ 210-260 VAC
DC Power (45)	712A	Input	12-30 VDC
External Reference (46)	BNC	Input/Output	10 MHz RF

Table B-1 Table of I/O Ports

B-2 PIN-OUT TABLE FOR MIC/ACC CONNECTOR

Pin No.	Signal Name	Signal Type	Input/Output
1	+12 VDC	DC Voltage	1/8 AMP Fused Output
2	Chassis GND		
3	Mic Key	Switched	GND for Generate
4	Mic Audio	Audio	Input
5	Tone Key	Switched	GND to Remove Variable Tone

Table B-2 MIC/ACC Connector Pin Assignments

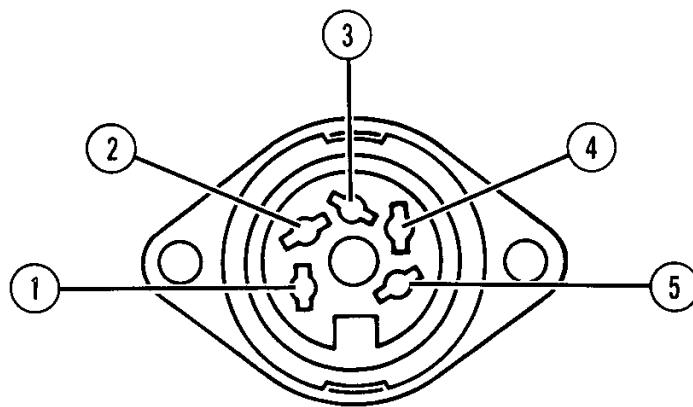

Figure B-1 MIC/ACC Connector Pin Identification
(Front View)

B-3 PIN-OUT TABLE FOR RS-232 CONNECTOR

The FM/AM-1200S/A is configured as Data Terminal Equipment (DTE).

Pin No.	Input/Output	Remarks
2 (RDX)	Commands	If high, FM/AM-1200S/A can receive command. If low, FM/AM-1200S/A busy. If low, terminal not ready to receive. If not used, it must be tied high.
3 (TDX)	Info	
4 (RTS)		
5 (CTS)		
7 (Common Ground)		
1, 6, and 8 thru 25 not used		

Table B-3 RS-232 Connector Pin Assignments (Standard)

NOTE

A special cable (to be configured by the user) may be necessary to interface the RS-232 port to an external controller and/or printer.

FM/AM-1200S/A PROTOCOL

No Parity	Bit 8 Must Be Zero (Most Significant Bit)
Must Be Half Duplex	1 Stop Bit (End of Character)
Must Be Upper Case	High Level = -12 V
8 Data Bits Per Character	Low Level = +12 V
Pin No.	Assignment
7	Common Ground
13	CTS
14	RDX
16	TDX
18	GND
19	RTS
1 thru 6, 8 thru 12, 15, 17, 20 thru 25	Not Used

Table B-4 RS-232 Connector Pin Assignments with Cellular Testing (Option 15) Installed

B-4 PIN-OUT TABLE FOR GPIB CONNECTOR (OPTION 13)

When the GPIB Option (Option 13) is installed, a 24-pin connector is provided on the rear panel for connection to an external controller. Pinouts are shown in the Table below. The operator should ensure proper interface between the FM/AM-1200S/A and the external controller.

Once the proper connection is made, the FM/AM-1200S/A can be initialized with the proper address by using the GPIB Menu.

Pin No.	Signal	Pin No.	Signal
1	DIO 1	13	DIO 5
2	DIO 2	14	DIO 6
3	DIO 3	15	DIO 7
4	DIO 4	16	DIO 8
5	EOI	17	REN
6	DAV	18	Ground
7	NRFD	19	Ground
8	NDAC	20	Ground
9	IFC	21	Ground
10	SRQ	22	Ground
11	ATN	23	Ground
12	Ground	24	Ground

Table B-5 Pin-Out Table for GPIB Connector

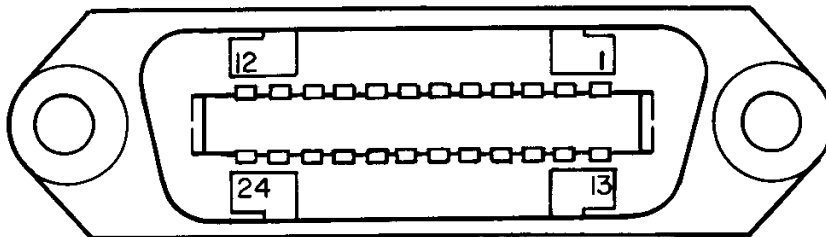

Figure B-2 GPIB Connector Pin Identification

APPENDIX C - MINIMUM PERFORMANCE CHECK

C-1 GENERAL

This section contains a quick, qualitative, step-by-step check for assessing the performance of the FM/AM-1200S/A. This check should be used when the operating condition of the set is in question. The check contained in this section is performed using the FM/AM-1200S/A front panel controls and does not require the removal of the exterior case. This check can be performed within 4 to 6 minutes, while the set is operating on its own internal battery power. Only a two foot length of 50Ω coaxial cable (with BNC connectors on each end) is required as accessory equipment to perform this check.

NOTE

If a determination is made that the FM/AM-1200S/A is not performing properly as a result of this performance check, the operator/technician should perform a thorough laboratory or bench check before taking any corrective maintenance action.

C-1-1 PRECHECK CONSIDERATIONS

For maximum benefit of the performance check, it is strongly recommended that personnel:

1. Thoroughly read and understand all steps of the check prior to actual initiation.
2. Be familiar with the FM/AM-1200S/A front and rear panel controls, indicators and connectors, as described in Section 3 of this manual. The performance check assumes the operator/technician is familiar with the set.

C-2 MINIMUM PERFORMANCE CHECK

SPECIAL ACCESSORY

EQUIPMENT REQ'D: One 2-foot length of 50Ω coaxial cable w/BNC connectors on each end.

TEST SET-UP DIAGRAM:

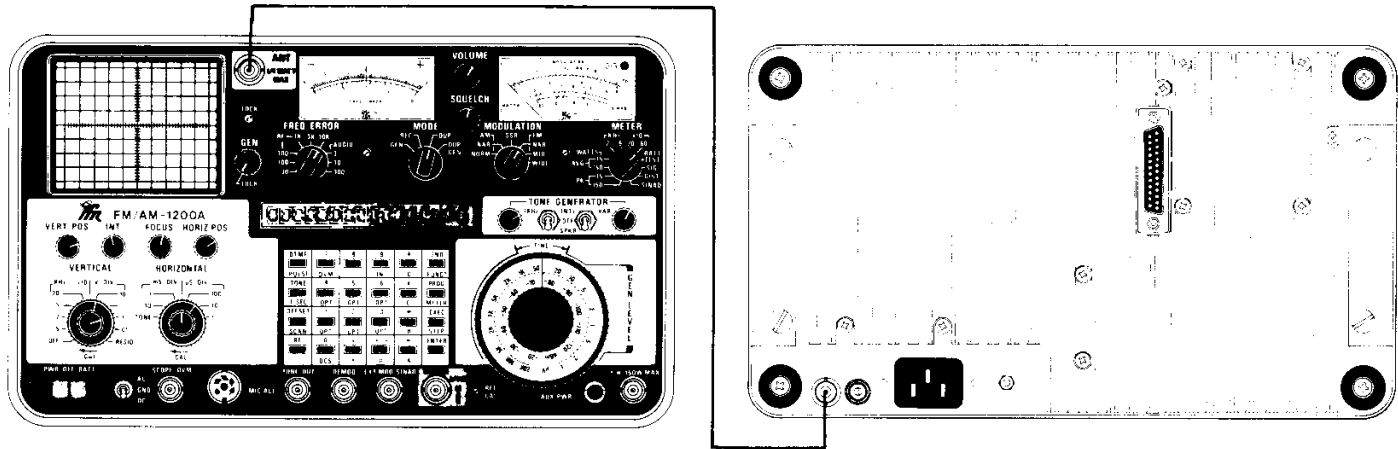

Figure C-1 Performance Test Set-Up Diagram

CONTROL	INITIAL SETTING
3 MODULATION Select Control	"AM" - "NORMAL"
4 Modulation METER Control	"BATT TEST"
5 VAR Tone Selector Switch	"OFF"
6 VAR Tone Level Control	full ccw
7 1 kHz Tone Selector Switch	"OFF"
8 1 kHz Tone Level Control	full ccw
10 RF Level Attenuator Vernier Control	full ccw
21 AC/GND/DC Switch	"GND"
22 PWR/OFF/ BATT Switch	"OFF"
23 VERTICAL Attenuator Selector Control	"OFF"
32 GEN/LOCK Control	"LOCK"
35 FREQ ERROR Meter Range Selector Control	"10K"
39 MODE Selector Control	"REC"

Table C-1 Initial Control Settings

- | STEP | PROCEDURE |
|------|---|
| 1. | Set FM/AM-1200S/A controls to initial settings described in Table C-1. |
| 2. | Connect 2-foot length of 50Ω coaxial cable between ANT Connector (34) and External Reference Connector (46) as shown in Figure C-1. |
| 3. | Place PWR/OFF/BATT Switch (22) to either "PWR" or "BATT" position and observe the following indications: |

STEP

PROCEDURE

3. (Cont'd)

- a. "IFR's FM/AM-1200S/A" illuminated on VFD (37) for approximately two seconds, followed by "VERSION X.X.X. XX.XX", before the RF function appears.

NOTE

CHECKSUM ERROR followed by MEMORY RESET displayed on VFD (37), in place of the sequence described above, indicates the pre-programmed data may have been lost.

NOTE

If the PWR/OFF/BATT Switch (22) was placed to the "BATT" position, place Modulation METER Control (4) to the "BATT TEST" position and verify MODULATION Meter (1) indicates within the BATT range.

If using internal battery power and external AC or DC power is available, place PWR/OFF/BATT Switch (22) to "PWR" position before continuing.

- b. Steady illumination of generator LOCK Lamp (33).

NOTE

If LOCK Lamp (33) is flashing, check position of GEN/LOCK Control (32) to be as indicated in Table C-1.

If LOCK Lamp (33) is steady, rotate GEN/LOCK Control (32) out of "LOCK" position and verify LOCK Lamp (33) flashes.

4. Using Keyboard (18), select 10 MHz (RF function).
5. Place VERTICAL Attenuator Selector Control (24) to any position except "OFF".
6. (FM/AM-1200S only) Place HORIZONTAL Sweep Selector Control (26) to desired position in Spectrum Analyzer range to observe 10 MHz.
7. Place Modulation METER Control (4) to "SIG" position and observe signal strength (relative deflection of meter).

STEP

PROCEDURE

8. Verify FREQ ERROR Meter (36) is centered.
9. Place FREQ ERROR Meter Range Selector Control (35) to the RF "1K" position.
10. Using Keyboard (18), slew last character of RF function up and down 5 units and verify deflection on FREQ ERROR Meter (36).

RECEIVING WWV TIME STANDARD TO CALIBRATE FM/AM-1200S/A
MASTER OSCILLATOR (Off-The-Air)

1. Connect BNC Tee Connector to ANT Connector (34).
2. Connect antenna to one side of Tee Connector.
3. Connect 2 foot length 50 Ω coax cable between the External Reference Connector (45) to other end of BNC Tee Connector.

NOTE

Loosely connect coax cable to BNC Tee Connector,
so as not to swamp out the received WWV signal.

4. Adjust REF CAL Adjustment (13) on FM/AM-1200S/A front panel to obtain a suitable beat note (zero beat) from the FM/AM-1200S/A speaker.

APPENDIX D - LIST OF ABBREVIATIONS

A	- Ampere
AC or ac	- Alternating Current
Adj	- Adjustment
AGC	- Automatic Gain Control
AM	- Amplitude Modulation
Amp	- Ampere
ANALY DISP.	- Analyzer Dispersion
Assy	- Assembly
BATT	- Battery
BCD	- Binary Coded Decimal
BFO	- Beat Frequency Oscillator
°C	- Degrees Celsius
CAL	- Calibration
ccw	- Counterclockwise
CRT	- Cathode Ray Tube
cw	- Clockwise
CW	- Carrier Wave
DAC	- Digital to Analog Converter
dB	- decibels
dBc	- decibels above (or below) carrier level
dBm	- decibels above (or below) 1 milliwatt
DC or dc	- Direct Current
DCR	- Duty Cycle Regulator
DEFLEC AMP	- Deflection Amplifier
DEMOD	- Demodulation, demodulate or demodulated
DEV	- Deviation
DMM	- Digital Multimeter
DVM	- Digital Voltmeter
ECL	- Emitter Coupled Logic
EXT ACC	- External Accessory
EXT MOD	- External Modulation
EXT DC	- External Direct Current
°F	- Degrees Fahrenheit
FET	- Field Effect Transistor
FILT	- Filter
FM	- Frequency Modulation
FREQ	- Frequency
GEN	- Generate
GHz	- Gigahertz
GND	- Ground
HI LVL	- High Level
HORIZ	- Horizontal
Hz	- Hertz
IC	- Integrated Circuit
IF	- Intermediate Frequency
IMTS	- Improved Mobile Telephone Service
INT MOD	- Internal Modulation
IPC	- Illustrated Parts Catalog
Kg/cm ³	- Kilogram per cubic centimeter
kHz	- kilohertz

L/H - Left-hand
LOG LIN - Logarithmic Linearity
LO - Local Oscillator
mA - Milliamperes
MAX DISP - Maximum Dispersion
Mech - Mechanical
MHz - Megahertz
MON - Monitor
 μ s - microsecond
 μ V - microvolt
ms or mSec - millisecond
mV - millivolt
mW - milliwatt
MULT - Multiplier
N/A - Not Applicable
NORM - Normal
OSC - Oscillator
para - paragraph
PC Bd - Printed Circuit Board
PLL - Phase Lock Loop
Preamp - Preamplifier
psi - pounds per square inch
PWR - Power
PWR MON - Power Monitor
RCVR - Receiver
REF - Reference
RF - Radio Frequency
R/H - Right-hand
RMS - Root Mean Square
ROM - Read Only Memory
sec - Seconds
Scope Dev - Oscilloscope Deviation
SIG - Signal
SSB - Single Sideband
SW - Switch
TCXO - Temperature Compensated Crystal Oscillator
TRANS - Transmitter or Transceiver
TTL - Transistor Transistor Logic
V - Volts
Vp - Volts Peak
Vp-p - Volts Peak-to-Peak
VAC - Volts Alternating Current
VCO - Voltage Controlled Oscillator
VDC - Volts Direct Current
VHF - Very High Frequency
VOL - Volume
VSWR - Voltage Standing Wave Ratio
W - Watts
XMTR - Transmitter
XTAL - Crystal

APPENDIX E - REPACKING FOR SHIPMENT

E-1 SHIPPING INFORMATION

IFR test sets returned to factory for calibration, service or repair must be repackaged and shipped subject to the following conditions:

Do not return any products to factory without first receiving authorization from IFR Customer Service Department.

CONTACT: Customer Service Dept.
IFR, Inc.
10200 West York Street
Wichita, Kansas 67215

Telephone: (800)-835-2350
TWX: 910-741-6952

All test sets must be tagged with:

- a. Owner's identification and address.
- b. Nature of service or repair required.
- c. Model No.
- d. Serial No.

Sets must be repackaged in original shipping containers using IFR packing models. If original shipping containers and materials are not available, contact IFR Customer Service Dept. for shipping instructions.

All freight costs on non-warranty shipments are assumed by customer. (See "Warranty Packet" for freight charge policy on warranty claims.)

E-2 REPACKING PROCEDURE (REFERENCE - FIGURE E-1)

1. Make sure bottom packing mold is seated on floor of shipping container.
2. Carefully wrap test set with polyethylene sheeting to protect finish.
3. Place test set into shipping container, making sure set is securely seated in bottom packing mold.
4. Place top packing mold over top of set and press down until mold rests solidly on bottom packing mold.
5. Close shipping container lids and seal with shipping tape or an industrial stapler. Tie all sides of container with break-resistant rope, twine or equivalent.

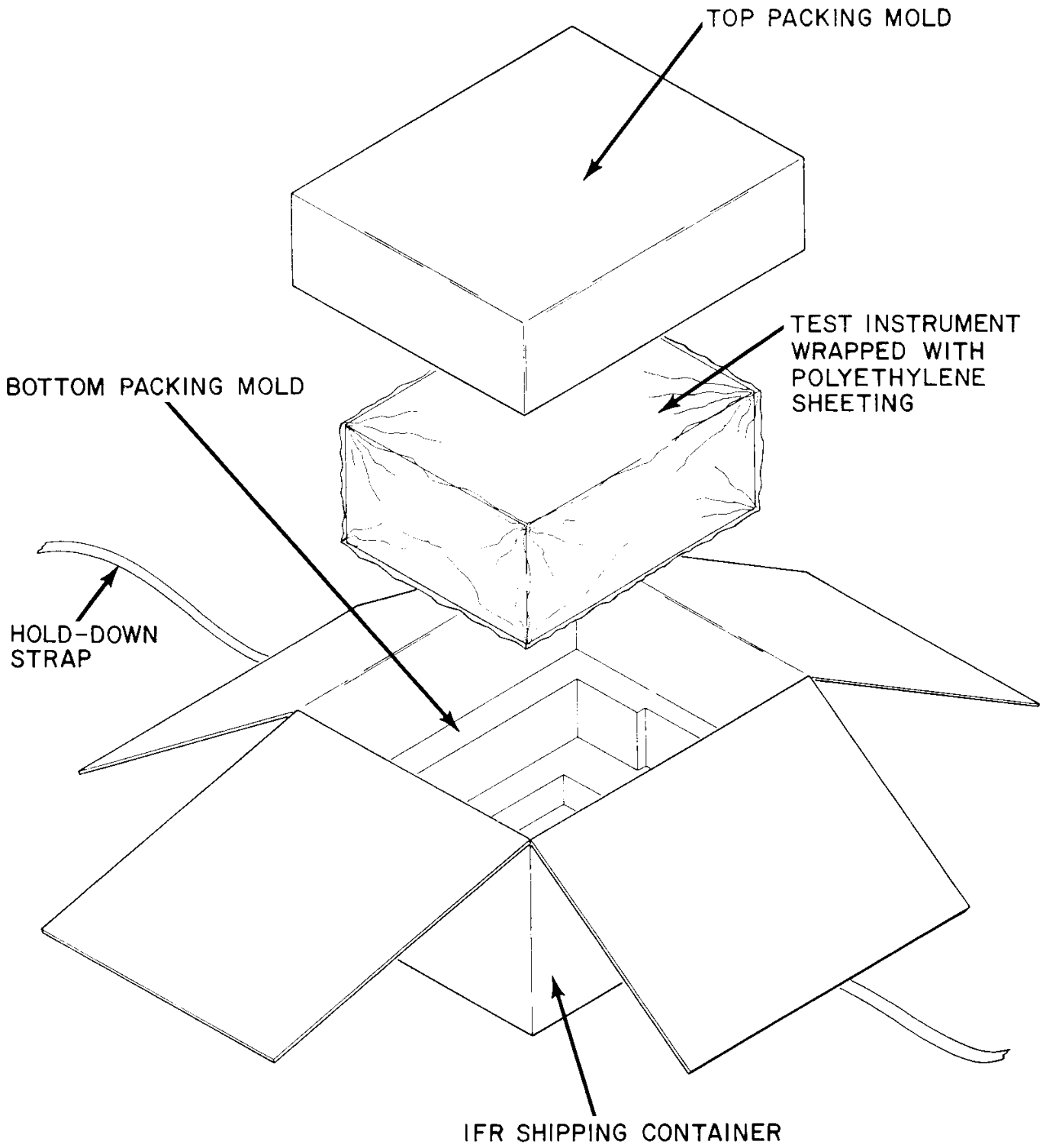

Figure E-1 Repacking for Shipment

**APPENDIX F - TRUNKING TEST SYSTEMS CHANNEL NUMBER
TRANSMIT/RECEIVE FREQUENCIES**

Channel Number	LOW FREQUENCY BAND		Channel Number	LOW FREQUENCY BAND	
	Mobile Transmit	Mobile Receive		Mobile Transmit	Mobile Receive
1	806.0125	851.0125	40	806.9875	851.9875
2	806.0375	851.0375	41	807.0125	852.0125
3	806.0625	851.0625	42	807.0375	852.0375
4	806.0875	851.0875	43	807.0625	852.0625
5	806.1125	851.1125	44	807.0875	852.0875
6	806.1375	851.1375	45	807.1125	852.1125
7	806.1625	851.1625	46	807.1375	852.1375
8	806.1875	851.1875	47	807.1625	852.1625
9	806.2125	851.2125	48	807.1875	852.1875
10	806.2375	851.2375	49	807.2125	852.2125
11	806.2625	851.2625	50	807.2375	852.2375
12	806.2875	851.2875	51	807.2625	852.2625
13	806.3125	851.3125	52	807.2875	852.2875
14	806.3375	851.3375	53	807.3125	852.3125
15	806.3625	851.3625	54	807.3375	852.3375
16	806.3875	851.3875	55	807.3625	852.3625
17	806.4125	851.4125	56	807.3875	852.3875
18	806.4375	851.4375	57	807.4125	852.4125
19	806.4625	851.4625	58	807.4375	852.4375
20	806.4875	851.4875	59	807.4625	852.4625
21	806.5125	851.5125	60	807.4875	852.4875
22	806.5375	851.5375	61	807.5125	852.5125
23	806.5625	851.5625	62	807.5375	852.5375
24	806.5875	851.5875	63	807.5625	852.5625
25	806.6125	851.6125	64	807.5875	852.5875
26	806.6375	851.6375	65	807.6125	852.6125
27	806.6625	851.6625	66	807.6375	852.6375
28	806.6875	851.6875	67	807.6625	852.6625
29	806.7125	851.7125	68	807.6875	852.6875
30	806.7375	851.7375	69	807.7125	852.7125
31	806.7625	851.7625	70	807.7375	852.7375
32	806.7875	851.7875	71	807.7625	852.7625
33	806.8125	851.8125	72	807.7875	852.7875
34	806.8375	851.8375	73	807.8125	852.8125
35	806.8625	851.8625	74	807.8375	852.8375
36	806.8875	851.8875	75	807.8625	852.8625
37	806.9125	851.9125	76	807.8875	852.8875
38	806.9375	851.9375	77	807.9125	852.9125
39	806.9625	851.9625	78	807.9375	852.9375

Table F-1 Trunking Channel Low Frequency Band

LOW			LOW		
Channel	FREQUENCY	BAND	Channel	FREQUENCY	BAND
Number	Mobile	Mobile	Number	Mobile	Mobile
	Transmit	Receive		Transmit	Receive
79	807.9625	852.9625	118	808.9375	853.9375
80	807.9875	852.9875	119	808.9625	853.9625
81	808.0125	853.0125	120	808.9875	853.9875
82	808.0375	853.0375	121	809.0125	854.0125
83	808.0625	853.0625	122	809.0375	854.0375
84	808.0875	853.0875	123	809.0625	854.0625
85	808.1125	853.1125	124	809.0875	854.0875
86	808.1375	853.1375	125	809.1125	854.1125
87	808.1625	853.1625	126	809.1375	854.1375
88	808.1875	853.1875	127	809.1625	854.1625
89	808.2125	853.2125	128	809.1875	854.1875
90	808.2375	853.2375	129	809.2125	854.2125
91	808.2625	853.2625	130	809.2375	854.2375
92	808.2875	853.2875	131	809.2625	854.2625
93	808.3125	853.3125	132	809.2875	854.2875
94	808.3375	853.3375	133	809.3125	854.3125
95	808.3625	853.3625	134	809.3375	854.3375
96	808.3875	853.3875	135	809.3625	854.3625
97	808.4125	853.4125	136	809.3875	854.3875
98	808.4375	853.4375	137	809.4125	854.4125
99	808.4625	853.4625	138	809.4375	854.4375
100	808.4875	853.4875	139	809.4625	854.4625
101	808.5125	853.5125	140	809.4875	854.4875
102	808.5375	853.5375	141	809.5125	854.5125
103	808.5625	853.5625	142	809.5375	854.5375
104	808.5875	853.5875	143	809.5625	854.5625
105	808.6125	853.6125	144	809.5875	854.5875
106	808.6375	853.6375	145	809.6125	854.6125
107	808.6625	853.6625	146	809.6375	854.6375
108	808.6875	853.6875	147	809.6625	854.6625
109	808.7125	853.7125	148	809.6875	854.6875
110	808.7375	853.7375	149	809.7125	854.7125
111	808.7625	853.7625	150	809.7375	854.7375
112	808.7875	853.7875	151	809.7625	854.7625
113	808.8125	853.8125	152	809.7875	854.7875
114	808.8375	853.8375	153	809.8125	854.8125
115	808.8625	853.8625	154	809.8375	854.8375
116	808.8875	853.8875	155	809.8625	854.8625
117	808.9125	853.9125	156	809.8875	854.8875

Table F-1 Trunking Channel Low Frequency Band (Continued)

LOW FREQUENCY BAND			LOW FREQUENCY BAND		
Channel Number	Mobile Transmit	Mobile Receive	Channel Number	Mobile Transmit	Mobile Receive
157	809.9125	854.9125	196	810.8875	855.8875
158	809.9375	854.9375	197	810.9125	855.9125
159	809.9625	854.9625	198	810.9375	855.9375
160	809.9875	854.9875	199	810.9625	855.9625
161	810.0125	855.0125	200	810.9875	855.9875
162	810.0375	855.0375	201	811.0125	856.0125
163	810.0625	855.0625	202	811.0375	856.0375
164	810.0875	855.0875	203	811.0625	856.0625
165	810.1125	855.1125	204	811.0875	856.0875
166	810.1375	855.1375	205	811.1125	856.1125
167	810.1625	855.1625	206	811.1375	856.1375
168	810.1875	855.1875	207	811.1625	856.1625
169	810.2125	855.2125	208	811.1875	856.1875
170	810.2375	855.2375	209	811.2125	856.2125
171	810.2625	855.2625	210	811.2375	856.2375
172	810.2875	855.2875	211	811.2625	856.2625
173	810.3125	855.3125	212	811.2875	856.2875
174	810.3375	855.3375	213	811.3125	856.3125
175	810.3625	855.3625	214	811.3375	856.3375
176	810.3875	855.3875	215	811.3625	856.3625
177	810.4125	855.4125	216	811.3875	856.3875
178	810.4375	855.4375	217	811.4125	856.4125
179	810.4625	855.4625	218	811.4375	856.4375
180	810.4875	855.4875	219	811.4625	856.4625
181	810.5125	855.5125	220	811.4875	856.4875
182	810.5375	855.5375	221	811.5125	856.5125
183	810.5625	855.5625	222	811.5375	856.5375
184	810.5875	855.5875	223	811.5625	856.5625
185	810.6125	855.6125	224	811.5875	856.5875
186	810.6375	855.6375	225	811.6125	856.6125
187	810.6625	855.6625	226	811.6375	856.6375
188	810.6875	855.6875	227	811.6625	856.6625
189	810.7125	855.7125	228	811.6875	856.6875
190	810.7375	855.7375	229	811.7125	856.7125
191	810.7625	855.7625	230	811.7375	856.7375
192	810.7875	855.7875	231	811.7625	856.7625
193	810.8125	855.8125	232	811.7875	856.7875
194	810.8375	855.8375	233	811.8125	856.8125
195	810.8625	855.8625	234	811.8375	856.8375

Table F-1 Trunking Channel Low Frequency Band (Continued)

Channel Number	LOW FREQUENCY BAND		Channel Number	LOW FREQUENCY BAND	
	Mobile Transmit	Mobile Receive		Mobile Transmit	Mobile Receive
235	811.8625	856.8625	274	812.8375	857.8375
236	811.8875	856.8875	275	812.8625	857.8625
237	811.9125	856.9125	276	812.8875	857.8875
238	811.9375	856.9375	277	812.9125	857.9125
239	811.9625	856.9625	278	812.9375	857.9375
240	811.9875	856.9875	279	812.9625	857.9625
241	812.0125	857.0125	280	812.9875	857.9875
242	812.0375	857.0375	281	813.0125	858.0125
243	812.0625	857.0625	282	813.0375	858.0375
244	812.0875	857.0875	283	813.0625	858.0625
245	812.1125	857.1125	284	813.0875	858.0875
246	812.1375	857.1375	285	813.1125	858.1125
247	812.1625	857.1625	286	813.1375	858.1375
248	812.1875	857.1875	287	813.1625	858.1625
249	812.2125	857.2125	288	813.1875	858.1875
250	812.2375	857.2375	289	813.2125	858.2125
251	812.2625	857.2625	290	813.2375	858.2375
252	812.2875	857.2875	291	813.2625	858.2625
253	812.3125	857.3125	292	813.2875	858.2875
254	812.3375	857.3375	293	813.3125	858.3125
255	812.3625	857.3625	294	813.3375	858.3375
256	812.3875	857.3875	295	813.3625	858.3625
257	812.4125	857.4125	296	813.3875	858.3875
258	812.4375	857.4375	297	813.4125	858.4125
259	812.4625	857.4625	298	813.4375	858.4375
260	812.4875	857.4875	299	813.4625	858.4625
261	812.5125	857.5125	300	813.4875	858.4875
262	812.5375	857.5375	301	813.5125	858.5125
263	812.5625	857.5625	302	813.5375	858.5375
264	812.5875	857.5875	303	813.5625	858.5625
265	812.6125	857.6125	304	813.5875	858.5875
266	812.6375	857.6375	305	813.6125	858.6125
267	812.6625	857.6625	306	813.6375	858.6375
268	812.6875	857.6875	307	813.6625	858.6625
269	812.7125	857.7125	308	813.6875	858.6875
270	812.7375	857.7375	309	813.7125	858.7125
271	812.7625	857.7625	310	813.7375	858.7375
272	812.7875	857.7875	311	813.7625	858.7625
273	812.8125	857.8125	312	813.7875	858.7875

Table F-1 Trunking Channel Low Frequency Band (Continued)

Channel Number	LOW FREQUENCY BAND		Channel Number	LOW FREQUENCY BAND	
	Mobile Transmit	Mobile Receive		Mobile Transmit	Mobile Receive
313	813.8125	858.8125	352	814.7875	859.7875
314	813.8375	858.8375	353	814.8125	859.8125
315	813.8625	858.8625	354	814.8375	859.8375
316	813.8875	858.8875	355	814.8625	859.8625
317	813.9125	858.9125	356	814.8875	859.8875
318	813.9375	858.9375	357	814.9125	859.9125
319	813.9625	858.9625	358	814.9375	859.9375
320	813.9875	858.9875	359	814.9625	859.9625
321	814.0125	859.0125	360	814.9875	859.9875
322	814.0375	859.0375	361	815.0125	860.0125
323	814.0625	859.0625	362	815.0375	860.0375
324	814.0875	859.0875	363	815.0625	860.0625
325	814.1125	859.1125	364	815.0875	860.0875
326	814.1375	859.1375	365	815.1125	860.1125
327	814.1625	859.1625	366	815.1375	860.1375
328	814.1875	859.1875	367	815.1625	860.1625
329	814.2125	859.2125	368	815.1875	860.1875
330	814.2375	859.2375	369	815.2125	860.2125
331	814.2625	859.2625	370	815.2375	860.2375
332	814.2875	859.2875	371	815.2625	860.2625
333	814.3125	859.3125	372	815.2875	860.2875
334	814.3375	859.3375	373	815.3125	860.3125
335	814.3625	859.3625	374	815.3375	860.3375
336	814.3875	859.3875	375	815.3625	860.3625
337	814.4125	859.4125	376	815.3875	860.3875
338	814.4375	859.4375	377	815.4125	860.4125
339	814.4625	859.4625	378	815.4375	860.4375
340	814.4875	859.4875	379	815.4625	860.4625
341	814.5125	859.5125	380	815.4875	860.4875
342	814.5375	859.5375	381	815.5125	860.5125
343	814.5625	859.5625	382	815.5375	860.5375
344	814.5875	859.5875	383	815.5625	860.5625
345	814.6125	859.6125	384	815.5875	860.5875
346	814.6375	859.6375	385	815.6125	860.6125
347	814.6625	859.6625	386	815.6375	860.6375
348	814.6875	859.6875	387	815.6625	860.6625
349	814.7125	859.7125	388	815.6875	860.6875
350	814.7375	859.7375	389	815.7125	860.7125
351	814.7625	859.7625	390	815.7375	860.7375

Table F-1 Trunking Channel Low Frequency Band (Continued)

Channel Number	LOW FREQUENCY BAND		Channel Number	LOW FREQUENCY BAND	
	Mobile Transmit	Mobile Receive		Mobile Transmit	Mobile Receive
391	815.7625	860.7625	430	816.7375	861.7375
392	815.7875	860.7875	431	816.7625	861.7625
393	815.8125	860.8125	432	816.7875	861.7875
394	815.8375	860.8375	433	816.8125	861.8125
395	815.8625	860.8625	434	816.8375	861.8375
396	815.8875	860.8875	435	816.8625	861.8625
397	815.9125	860.9125	436	816.8875	861.8875
398	815.9375	860.9375	437	816.9125	861.9125
399	815.9625	860.9625	438	816.9375	861.9375
400	815.9875	860.9875	439	816.9625	861.9625
401	816.0125	861.0125	440	816.9875	861.9875
402	816.0375	861.0375	441	817.0125	862.0125
403	816.0625	861.0625	442	817.0375	862.0375
404	816.0875	861.0875	443	817.0625	862.0625
405	816.1125	861.1125	444	817.0875	862.0875
406	816.1375	861.1375	445	817.1125	862.1125
407	816.1625	861.1625	446	817.1375	862.1375
408	816.1875	861.1875	447	817.1625	862.1625
409	816.2125	861.2125	448	817.1875	862.1875
410	816.2375	861.2375	449	817.2125	862.2125
411	816.2625	861.2625	450	817.2375	862.2375
412	816.2875	861.2875	451	817.2625	862.2625
413	816.3125	861.3125	452	817.2875	862.2875
414	816.3375	861.3375	453	817.3125	862.3125
415	816.3625	861.3625	454	817.3375	862.3375
416	816.3875	861.3875	455	817.3625	862.3625
417	816.4125	861.4125	456	817.3875	862.3875
418	816.4375	861.4375	457	817.4125	862.4125
419	816.4625	861.4625	458	817.4375	862.4375
420	816.4875	861.4875	459	817.4625	862.4625
421	816.5125	861.5125	460	817.4875	862.4875
422	816.5375	861.5375	461	817.5125	862.5125
423	816.5625	861.5625	462	817.5375	862.5375
424	816.5875	861.5875	463	817.5625	862.5625
425	816.6125	861.6125	464	817.5875	862.5875
426	816.6375	861.6375	465	817.6125	862.6125
427	816.6625	861.6625	466	817.6375	862.6375
428	816.6875	861.6875	467	817.6625	862.6625
429	816.7125	861.7125	468	817.6875	862.6875

Table F-1 Trunking Channel Low Frequency Band (Continued)

Channel Number	LOW FREQUENCY BAND		Channel Number	LOW FREQUENCY BAND	
	Mobile Transmit	Mobile Receive		Mobile Transmit	Mobile Receive
469	817.7125	862.7125	508	818.6875	863.6875
470	817.7375	862.7375	509	818.7125	863.7125
471	817.7625	862.7625	510	818.7375	863.7375
472	817.7875	862.7875	511	818.7625	863.7625
473	817.8125	862.8125	512	818.7875	863.7875
474	817.8375	862.8375	513	818.8125	863.8125
475	817.8625	862.8625	514	818.8375	863.8375
476	817.8875	862.8875	515	818.8625	863.8625
477	817.9125	862.9125	516	818.8875	863.8875
478	817.9375	862.9375	517	818.9125	863.9125
479	817.9625	862.9625	518	818.9375	863.9375
480	817.9875	862.9875	519	818.9625	863.9625
481	818.0125	863.0125	520	818.9875	863.9875
482	818.0375	863.0375	521	819.0125	864.0125
483	818.0625	863.0625	522	819.0375	864.0375
484	818.0875	863.0875	523	819.0625	864.0625
485	818.1125	863.1125	524	819.0875	864.0875
486	818.1375	863.1375	525	819.1125	864.1125
487	818.1625	863.1625	526	819.1375	864.1375
488	818.1875	863.1875	527	819.1625	864.1625
489	818.2125	863.2125	528	819.1875	864.1875
490	818.2375	863.2375	529	819.2125	864.2125
491	818.2625	863.2625	530	819.2375	864.2375
492	818.2875	863.2875	531	819.2625	864.2625
493	818.3125	863.3125	532	819.2875	864.2875
494	818.3375	863.3375	533	819.3125	864.3125
495	818.3625	863.3625	534	819.3375	864.3375
496	818.3875	863.3875	535	819.3625	864.3625
497	818.4125	863.4125	536	819.3875	864.3875
498	818.4375	863.4375	537	819.4125	864.4125
499	818.4625	863.4625	538	819.4375	864.4375
500	818.4875	863.4875	539	819.4625	864.4625
501	818.5125	863.5125	540	819.4875	864.4875
502	818.5375	863.5375	541	819.5125	864.5125
503	818.5625	863.5625	542	819.5375	864.5375
504	818.5875	863.5875	543	819.5625	864.5625
505	818.6125	863.6125	544	819.5875	864.5875
506	818.6375	863.6375	545	819.6125	864.6125
507	818.6625	863.6625	546	819.6375	864.6375

Table F-1 Trunking Channel Low Frequency Band (Continued)

Channel Number	LOW FREQUENCY BAND		Channel Number	LOW FREQUENCY BAND	
	Mobile Transmit	Mobile Receive		Mobile Transmit	Mobile Receive
547	819.6625	864.6625	574	820.3375	865.3375
548	819.6875	864.6875	575	820.3625	865.3625
549	819.7125	864.7125	576	820.3875	865.3875
550	819.7375	864.7375	577	820.4125	865.4125
551	819.7625	864.7625	578	820.4375	865.4375
552	819.7875	864.7875	579	820.4625	865.4625
553	819.8125	864.8125	580	820.4875	865.4875
554	819.8375	864.8375	581	820.5125	865.5125
555	819.8625	864.8625	582	820.5375	865.5375
556	819.8875	864.8875	583	820.5625	865.5625
557	819.9125	864.9125	584	820.5875	865.5875
558	819.9375	864.9375	585	820.6125	865.6125
559	819.9625	864.9625	586	820.6375	865.6375
560	819.9875	864.9875	587	820.6625	865.6625
561	820.0125	865.0125	588	820.6875	865.6875
562	820.0375	865.0375	589	820.7125	865.7125
563	820.0625	865.0625	590	820.7375	865.7375
564	820.0875	865.0875	591	820.7625	865.7625
565	820.1125	865.1125	592	820.7875	865.7875
566	820.1375	865.1375	593	820.8125	865.8125
567	820.1625	865.1625	594	820.8375	865.8375
568	820.1875	865.1875	595	820.8625	865.8625
569	820.2125	865.2125	596	820.8875	865.8875
570	820.2375	865.2375	597	820.9125	865.9125
571	820.2625	865.2625	598	820.9375	865.9375
572	820.2875	865.2875	599	820.9625	865.9625
573	820.3125	865.3125	600	820.9875	865.9875

Table F-1 Trunking Channel Low Frequency Band (Continued)

Channel Number	HIGH FREQUENCY BAND		Channel Number	HIGH FREQUENCY BAND	
	Mobile Transmit	Mobile Receive		Mobile Transmit	Mobile Receive
1	896.0125	935.0125	40	896.5000	935.5000
2	896.0250	935.0250	41	896.5125	935.5125
3	896.0375	935.0375	42	896.5250	935.5250
4	896.0500	935.0500	43	896.5375	935.5375
5	896.0625	935.0625	44	896.5500	935.5500
6	896.0750	935.0750	45	896.5625	935.5625
7	896.0875	935.0875	46	896.5750	935.5750
8	896.1000	935.1000	47	896.5875	935.5875
9	896.1125	935.1125	48	896.6000	935.6000
10	896.1250	935.1250	49	896.6125	935.6125
11	896.1375	935.1375	50	896.6250	935.6250
12	896.1500	935.1500	51	896.6375	935.6375
13	896.1625	935.1625	52	896.6500	935.6500
14	896.1750	935.1750	53	896.6625	935.6625
15	896.1875	935.1875	54	896.6750	935.6750
16	896.2000	935.2000	55	896.6875	935.6875
17	896.2125	935.2125	56	896.7000	935.7000
18	896.2250	935.2250	57	896.7125	935.7125
19	896.2375	935.2375	58	896.7250	935.7250
20	896.2500	935.2500	59	896.7375	935.7375
21	896.2625	935.2625	60	896.7500	935.7500
22	896.2750	935.2750	61	896.7625	935.7625
23	896.2875	935.2875	62	896.7750	935.7750
24	896.3000	935.3000	63	896.7875	935.7875
25	896.3125	935.3125	64	896.8000	935.8000
26	896.3250	935.3250	65	896.8125	935.8125
27	896.3375	935.3375	66	896.8250	935.8250
28	896.3500	935.3500	67	896.8375	935.8375
29	896.3625	935.3625	68	896.8500	935.8500
30	896.3750	935.3750	69	896.8625	935.8625
31	896.3875	935.3875	70	896.8750	935.8750
32	896.4000	935.4000	71	896.8875	935.8875
33	896.4125	935.4125	72	896.9000	935.9000
34	896.4250	935.4250	73	896.9125	935.9125
35	896.4375	935.4375	74	896.9250	935.9250
36	896.4500	935.4500	75	896.9375	935.9375
37	896.4625	935.4625	76	896.9500	935.9500
38	896.4750	935.4750	77	896.9625	935.9625
39	896.4875	935.4875	78	896.9750	935.9750

Table F-2 Trunking Channel High Frequency Band

Channel Number	HIGH FREQUENCY BAND		Channel Number	HIGH FREQUENCY BAND	
	Mobile Transmit	Mobile Receive		Mobile Transmit	Mobile Receive
79	896.9875	935.9875	118	897.4750	936.4750
80	897.0000	936.0000	119	897.4875	936.4875
81	897.0125	936.0125	120	897.5000	936.5000
82	897.0250	936.0250	121	897.5125	936.5125
83	897.0375	936.0375	122	897.5250	936.5250
84	897.0500	936.0500	123	897.5375	936.5375
85	897.0625	936.0625	124	897.5500	936.5500
86	897.0750	936.0750	125	897.5625	936.5625
87	897.0875	936.0875	126	897.5750	936.5750
88	897.1000	936.1000	127	897.5875	936.5875
89	897.1125	936.1125	128	897.6000	936.6000
90	897.1250	936.1250	129	897.6125	936.6125
91	897.1375	936.1375	130	897.6250	936.6250
92	897.1500	936.1500	131	897.6375	936.6375
93	897.1625	936.1625	132	897.6500	936.6500
94	897.1750	936.1750	133	897.6625	936.6625
95	897.1875	936.1875	134	897.6750	936.6750
96	897.2000	936.2000	135	897.6875	936.6875
97	897.2125	936.2125	136	897.7000	936.7000
98	897.2250	936.2250	137	897.7125	936.7125
99	897.2375	936.2375	138	897.7250	936.7250
100	897.2500	936.2500	139	897.7375	936.7375
101	897.2625	936.2625	140	897.7500	936.7500
102	897.2750	936.2750	141	897.7625	936.7625
103	897.2875	936.2875	142	897.7750	936.7750
104	897.3000	936.3000	143	897.7875	936.7875
105	897.3125	936.3125	144	897.8000	936.8000
106	897.3250	936.3250	145	897.8125	936.8125
107	897.3375	936.3375	146	897.8250	936.8250
108	897.3500	936.3500	147	897.8375	936.8375
109	897.3625	936.3625	148	897.8500	936.8500
110	897.3750	936.3750	149	897.8625	936.8625
111	897.3875	936.3875	150	897.8750	936.8750
112	897.4000	936.4000	151	897.8875	936.8875
113	897.4125	936.4125	152	897.9000	936.9000
114	897.4250	936.4250	153	897.9125	936.9125
115	897.4375	936.4375	154	897.9250	936.9250
116	897.4500	936.4500	155	897.9375	936.9375
117	897.4625	936.4625	156	897.9500	936.9500

Table F-2 Trunking Channel High Frequency Band (Continued)

Channel Number	HIGH FREQUENCY BAND		Channel Number	HIGH FREQUENCY BAND	
	Mobile Transmit	Mobile Receive		Mobile Transmit	Mobile Receive
157	897.9625	936.9625	196	898.4500	937.4500
158	897.9750	936.9750	197	898.4625	937.4625
159	897.9875	936.9875	198	898.4750	937.4750
160	898.0000	937.0000	199	898.4875	937.4875
161	898.0125	937.0125	200	898.5000	937.5000
162	898.0250	937.0250	201	898.5125	937.5125
163	898.0375	937.0375	202	898.5250	937.5250
164	898.0500	937.0500	203	898.5375	937.5375
165	898.0625	937.0625	204	898.5500	937.5500
166	898.0750	937.0750	205	898.5625	937.5625
167	898.0875	937.0875	206	898.5750	937.5750
168	898.1000	937.1000	207	898.5875	937.5875
169	898.1125	937.1125	208	898.6000	937.6000
170	898.1250	937.1250	209	898.6125	937.6125
171	898.1375	937.1375	210	898.6250	937.6250
172	898.1500	937.1500	211	898.6375	937.6375
173	898.1625	937.1625	212	898.6500	937.6500
174	898.1750	937.1750	213	898.6625	937.6625
175	898.1875	937.1875	214	898.6750	937.6750
176	898.2000	937.2000	215	898.6875	937.6875
177	898.2125	937.2125	216	898.7000	937.7000
178	898.2250	937.2250	217	898.7125	937.7125
179	898.2375	937.2375	218	898.7250	937.7250
180	898.2500	937.2500	219	898.7375	937.7375
181	898.2625	937.2625	220	898.7500	937.7500
182	898.2750	937.2750	221	898.7625	937.7625
183	898.2875	937.2875	222	898.7750	937.7750
184	898.3000	937.3000	223	898.7875	937.7875
185	898.3125	937.3125	224	898.8000	937.8000
186	898.3250	937.3250	225	898.8125	937.8125
187	898.3375	937.3375	226	898.8250	937.8250
188	898.3500	937.3500	227	898.8375	937.8375
189	898.3625	937.3625	228	898.8500	937.8500
190	898.3750	937.3750	229	898.8625	937.8625
191	898.3875	937.3875	230	898.8750	937.8750
192	898.4000	937.4000	231	898.8875	937.8875
193	898.4125	937.4125	232	898.9000	937.9000
194	898.4250	937.4250	233	898.9125	937.9125
195	898.4375	937.4375	234	898.9250	937.9250

Table F-2 Trunking Channel High Frequency Band (Continued)

Channel Number	HIGH FREQUENCY BAND		Channel Number	HIGH FREQUENCY BAND	
	Mobile Transmit	Mobile Receive		Mobile Transmit	Mobile Receive
235	898.9375	937.9375	274	899.4250	938.4250
236	898.9500	937.9500	275	899.4375	938.4375
237	898.9625	937.9625	276	899.4500	938.4500
238	898.9750	937.9750	277	899.4625	938.4625
239	898.9875	937.9875	278	899.4750	938.4750
240	899.0000	938.0000	279	899.4875	938.4875
241	899.0125	938.0125	280	899.5000	938.5000
242	899.0250	938.0250	281	899.5125	938.5125
243	899.0375	938.0375	282	899.5250	938.5250
244	899.0500	938.0500	283	899.5375	938.5375
245	899.0625	938.0625	284	899.5500	938.5500
246	899.0750	938.0750	285	899.5625	938.5625
247	899.0875	938.0875	286	899.5750	938.5750
248	899.1000	938.1000	287	899.5875	938.5875
249	899.1125	938.1125	288	899.6000	938.6000
250	899.1250	938.1250	289	899.6125	938.6125
251	899.1375	938.1375	290	899.6250	938.6250
252	899.1500	938.1500	291	899.6375	938.6375
253	899.1625	938.1625	292	899.6500	938.6500
254	899.1750	938.1750	293	899.6625	938.6625
255	899.1875	938.1875	294	899.6750	938.6750
256	899.2000	938.2000	295	899.6875	938.6875
257	899.2125	938.2125	296	899.7000	938.7000
258	899.2250	938.2250	297	899.7125	938.7125
259	899.2375	938.2375	298	899.7250	938.7250
260	899.2500	938.2500	299	899.7375	938.7375
261	899.2625	938.2625	300	899.7500	938.7500
262	899.2750	938.2750	301	899.7625	938.7625
263	899.2875	938.2875	302	899.7750	938.7750
264	899.3000	938.3000	303	899.7875	938.7875
265	899.3125	938.3125	304	899.8000	938.8000
266	899.3250	938.3250	305	899.8125	938.8125
267	899.3375	938.3375	306	899.8250	938.8250
268	899.3500	938.3500	307	899.8375	938.8375
269	899.3625	938.3625	308	899.8500	938.8500
270	899.3750	938.3750	309	899.8625	938.8625
271	899.3875	938.3875	310	899.8750	938.8750
272	899.4000	938.4000	311	899.8875	938.8875
273	899.4125	938.4125	312	899.9000	938.9000

Table F-2 Trunking Channel High Frequency Band (Continued)

Channel Number	HIGH FREQUENCY BAND		Channel Number	HIGH FREQUENCY BAND	
	Mobile Transmit	Mobile Receive		Mobile Transmit	Mobile Receive
313	899.9125	938.9125	352	900.4000	939.4000
314	899.9250	938.9250	353	900.4125	939.4125
315	899.9375	938.9375	354	900.4250	939.4250
316	899.9500	938.9500	355	900.4375	939.4375
317	899.9625	938.9625	356	900.4500	939.4500
318	899.9750	938.9750	357	900.4625	939.4625
319	899.9875	938.9875	358	900.4750	939.4750
320	900.0000	939.0000	359	900.4875	939.4875
321	900.0125	939.0125	360	900.5000	939.5000
322	900.0250	939.0250	361	900.5125	939.5125
323	900.0375	939.0375	362	900.5250	939.5250
324	900.0500	939.0500	363	900.5375	939.5375
325	900.0625	939.0625	364	900.5500	939.5500
326	900.0750	939.0750	365	900.5625	939.5625
327	900.0875	939.0875	366	900.5750	939.5750
328	900.1000	939.1000	367	900.5875	939.5875
329	900.1125	939.1125	368	900.6000	939.6000
330	900.1250	939.1250	369	900.6125	939.6125
331	900.1375	939.1375	370	900.6250	939.6250
332	900.1500	939.1500	371	900.6375	939.6375
333	900.1625	939.1625	372	900.6500	939.6500
334	900.1750	939.1750	373	900.6625	939.6625
335	900.1875	939.1875	374	900.6750	939.6750
336	900.2000	939.2000	375	900.6875	939.6875
337	900.2125	939.2125	376	900.7000	939.7000
338	900.2250	939.2250	377	900.7125	939.7125
339	900.2375	939.2375	378	900.7250	939.7250
340	900.2500	939.2500	379	900.7375	939.7375
341	900.2625	939.2625	380	900.7500	939.7500
342	900.2750	939.2750	381	900.7625	939.7625
343	900.2875	939.2875	382	900.7750	939.7750
344	900.3000	939.3000	383	900.7875	939.7875
345	900.3125	939.3125	384	900.8000	939.8000
346	900.3250	939.3250	385	900.8125	939.8125
347	900.3375	939.3375	386	900.8250	939.8250
348	900.3500	939.3500	387	900.8375	939.8375
349	900.3625	939.3625	388	900.8500	939.8500
350	900.3750	939.3750	389	900.8625	939.8625
351	900.3875	939.3875	390	900.8750	939.8750

Table F-2 Trunking Channel High Frequency Band (Continued)

Channel Number	HIGH FREQUENCY BAND		Channel Number	HIGH FREQUENCY BAND	
	Mobile Transmit	Mobile Receive		Mobile Transmit	Mobile Receive
391	900.8875	939.8875	396	900.9500	939.9500
392	900.9000	939.9000	397	900.9625	939.9625
393	900.9125	939.9125	398	900.9750	939.9750
394	900.9250	939.9250	399	900.9875	939.9875
395	900.9375	939.9375			

Table F-2 Trunking Channel High Frequency Band (Continued)

**APPENDIX G – CELLULAR TELEPHONE CHANNEL NUMBERS
AND ASSIGNED CENTER FREQUENCIES**

Channel Number	Mobile Transmit (MHz)	Mobile Receive (MHz)	Channel Number	Mobile Transmit (MHz)	Mobile Receive (MHz)
1	825.030	870.030	41	826.230	871.230
2	825.060	870.060	42	826.260	871.260
3	825.090	870.090	43	826.290	871.290
4	825.120	870.120	44	826.320	871.320
5	825.150	870.150	45	826.350	871.350
6	825.180	870.180	46	826.380	871.380
7	825.210	870.210	47	826.410	871.410
8	825.240	870.240	48	826.440	871.440
9	825.270	870.270	49	826.470	871.470
10	825.300	870.300	50	826.500	871.500
11	825.330	870.330	51	826.530	871.530
12	825.360	870.360	52	826.560	871.560
13	825.390	870.390	53	826.590	871.590
14	825.420	870.420	54	826.620	871.620
15	825.450	870.450	55	826.650	871.650
16	825.480	870.480	56	826.680	871.680
17	825.510	870.510	57	826.710	871.710
18	825.540	870.540	58	826.740	871.740
19	825.570	870.570	59	826.770	871.770
20	825.600	870.600	60	826.800	871.800
21	825.630	870.630	61	826.830	871.830
22	825.660	870.660	62	826.860	871.860
23	825.690	870.690	63	826.890	871.890
24	825.720	870.720	64	826.920	871.920
25	825.750	870.750	65	826.950	871.950
26	825.780	870.780	66	826.980	871.980
27	825.810	870.810	67	827.010	872.010
28	825.840	870.840	68	827.040	872.040
29	825.870	870.870	69	827.070	872.070
30	825.900	870.900	70	827.100	872.100
31	825.930	870.930	71	827.130	872.130
32	825.960	870.960	72	827.160	872.160
33	825.990	870.990	73	827.190	872.190
34	826.020	871.020	74	827.220	872.220
35	826.050	871.050	75	827.250	872.250
36	826.080	871.080	76	827.280	872.280
37	826.110	871.110	77	827.310	872.310
38	826.140	871.140	78	827.340	872.340
39	826.170	871.170	79	827.370	872.370
40	826.200	871.200	80	827.400	872.400

Table G-1 Cellular Channel Numbers and Frequencies

Channel Number	Mobile Transmit (MHz)	Mobile Receive (MHz)	Channel Number	Mobile Transmit (MHz)	Mobile Receive (MHz)
81	827.430	872.430	121	828.630	873.630
82	827.460	872.460	122	828.660	873.660
83	827.490	872.490	123	828.690	873.690
84	827.520	872.520	124	828.720	873.720
85	827.550	872.550	125	828.750	873.750
86	827.580	872.580	126	828.780	873.780
87	827.610	872.610	127	828.810	873.810
88	827.640	872.640	128	828.840	873.840
89	827.670	872.670	129	828.870	873.870
90	827.700	872.700	130	828.900	873.900
91	827.730	872.730	131	828.930	873.930
92	827.760	872.760	132	828.960	873.960
93	827.790	872.790	133	828.990	873.990
94	827.820	872.820	134	829.020	874.020
95	827.850	872.850	135	829.050	874.050
96	827.880	872.880	136	829.080	874.080
97	827.910	872.910	137	829.110	874.110
98	827.940	872.940	138	829.140	874.140
99	827.970	872.970	139	829.170	874.170
100	828.000	873.000	140	829.200	874.200
101	828.030	873.030	141	829.230	874.230
102	828.060	873.060	142	829.260	874.260
103	828.090	873.090	143	829.290	874.290
104	828.120	873.120	144	829.320	874.320
105	828.150	873.150	145	829.350	874.350
106	828.180	873.180	146	829.380	874.380
107	828.210	873.210	147	829.410	874.410
108	828.240	873.240	148	829.440	874.440
109	828.270	873.270	149	829.470	874.470
110	828.300	873.300	150	829.500	874.500
111	828.330	873.330	151	829.530	874.530
112	828.360	873.360	152	829.560	874.560
113	828.390	873.390	153	829.590	874.590
114	828.420	873.420	154	829.620	874.620
115	828.450	873.450	155	829.650	874.650
116	828.480	873.480	156	829.680	874.680
117	828.510	873.510	157	829.710	874.710
118	828.540	873.540	158	829.740	874.740
119	828.570	873.570	159	829.770	874.770
120	828.600	873.600	160	829.800	874.800

Table G-1 Cellular Channels and Frequencies (Cont)

Channel Number	Mobile Transmit (MHz)	Mobile Receive (MHz)	Channel Number	Mobile Transmit (MHz)	Mobile Receive (MHz)
161	829.830	874.830	201	831.030	876.030
162	829.860	874.860	202	831.060	876.060
163	829.890	874.890	203	831.090	876.090
164	829.920	874.920	204	831.120	876.120
165	829.950	874.950	205	831.150	876.150
166	829.980	874.980	206	831.180	876.180
167	830.010	875.010	207	831.210	876.210
168	830.040	875.040	208	831.240	876.240
169	830.070	875.070	209	831.270	876.270
170	830.100	875.100	210	831.300	876.300
171	830.130	875.130	211	831.330	876.330
172	830.160	875.160	212	831.360	876.360
173	830.190	875.190	213	831.390	876.390
174	830.220	875.220	214	831.420	876.420
175	830.250	875.250	215	831.450	876.450
176	830.280	875.280	216	831.480	876.480
177	830.310	875.310	217	831.510	876.510
178	830.340	875.340	218	831.540	876.540
179	830.370	875.370	219	831.570	876.570
180	830.400	875.400	220	831.600	876.600
181	830.430	875.430	221	831.630	876.630
182	830.460	875.460	222	831.660	876.660
183	830.490	875.490	223	831.690	876.690
184	830.520	875.520	224	831.720	876.720
185	830.550	875.550	225	831.750	876.750
186	830.580	875.580	226	831.780	876.780
187	830.610	875.610	227	831.810	876.810
188	830.640	875.640	228	831.840	876.840
189	830.670	875.670	229	831.870	876.870
190	830.700	875.700	230	831.900	876.900
191	830.730	875.730	231	831.930	876.930
192	830.760	875.760	232	831.960	876.960
193	830.790	875.790	233	831.990	876.990
194	830.820	875.820	234	832.020	877.020
195	830.850	875.850	235	832.050	877.050
196	830.880	875.880	236	832.080	877.080
197	830.910	875.910	237	832.110	877.110
198	830.940	875.940	238	832.140	877.140
199	830.970	875.970	239	832.170	877.170
200	831.000	876.000	240	832.200	877.200

Table G-1 Cellular Channels and Frequencies (Cont)

Channel Number	Mobile Transmit (MHz)	Mobile Receive (MHz)	Channel Number	Mobile Transmit (MHz)	Mobile Receive (MHz)
241	832.230	877.230	281	833.430	878.430
242	832.260	877.260	282	833.460	878.460
243	832.290	877.290	283	833.490	878.490
244	832.320	877.320	284	833.520	878.520
245	832.350	877.350	285	833.550	878.550
246	832.380	877.380	286	833.580	878.580
247	832.410	877.410	287	833.610	878.610
248	832.440	877.440	288	833.640	878.640
249	832.470	877.470	289	833.670	878.670
250	832.500	877.500	290	833.700	878.700
251	832.530	877.530	291	833.730	878.730
252	832.560	877.560	292	833.760	878.760
253	832.590	877.590	293	833.790	878.790
254	832.620	877.620	294	833.820	878.820
255	832.650	877.650	295	833.850	878.850
256	832.680	877.680	296	833.880	878.880
257	832.710	877.710	297	833.910	878.910
258	832.740	877.740	298	833.940	878.940
259	832.770	877.770	299	833.970	878.970
260	832.800	877.800	300	834.000	879.000
261	832.830	877.830	301	834.030	879.030
262	832.860	877.860	302	834.060	879.060
263	832.890	877.890	303	834.090	879.090
264	832.920	877.920	304	834.120	879.120
265	832.950	877.950	305	834.150	879.150
266	832.980	877.980	306	834.180	879.180
267	833.010	878.010	307	834.210	879.210
268	833.040	878.040	308	834.240	879.240
269	833.070	878.070	309	834.270	879.270
270	833.100	878.100	310	834.300	879.300
271	833.130	878.130	311	834.330	879.330
272	833.160	878.160	312	834.360	879.360
273	833.190	878.190	313	834.390	879.390
274	833.220	878.220	314	834.420	879.420
275	833.250	878.250	315	834.450	879.450
276	833.280	878.280	316	834.480	879.480
277	833.310	878.310	317	834.510	879.510
278	833.340	878.340	318	834.540	879.540
279	833.370	878.370	319	834.570	879.570
280	833.400	878.400	320	834.600	879.600

Table G-1 Cellular Channels and Frequencies (Cont)

Channel Number	Mobile Transmit (MHz)	Mobile Receive (MHz)	Channel Number	Mobile Transmit (MHz)	Mobile Receive (MHz)
321	834.630	879.630	361	835.830	880.830
322	834.660	879.660	362	835.860	880.860
323	834.690	879.690	363	835.890	880.890
324	834.720	879.720	364	835.920	880.920
325	834.750	879.750	365	835.950	880.950
326	834.780	879.780	366	835.980	880.980
327	834.810	879.810	367	836.010	881.010
328	834.840	879.840	368	836.040	881.040
329	834.870	879.870	369	836.070	881.070
330	834.900	879.900	370	836.100	881.100
331	834.930	879.930	371	836.130	881.130
332	834.960	879.960	372	836.160	881.160
333	834.990	879.990	373	836.190	881.190
334	835.020	880.020	374	836.220	881.220
335	835.050	880.050	375	836.250	881.250
336	835.080	880.080	376	836.280	881.280
337	835.110	880.110	377	836.310	881.310
338	835.140	880.140	378	836.340	881.340
339	835.170	880.170	379	836.370	881.370
340	835.200	880.200	380	836.400	881.400
341	835.230	880.230	381	836.430	881.430
342	835.260	880.260	382	836.460	881.460
343	835.290	880.290	383	836.490	881.490
344	835.320	880.320	384	836.520	881.520
345	835.350	880.350	385	836.550	881.550
346	835.380	880.380	386	836.580	881.580
347	835.410	880.410	387	836.610	881.610
348	835.440	880.440	388	836.640	881.640
349	835.470	880.470	389	836.670	881.670
350	835.500	880.500	390	836.700	881.700
351	835.530	880.530	391	836.730	881.730
352	835.560	880.560	392	836.760	881.760
353	835.590	880.590	393	836.790	881.790
354	835.620	880.620	394	836.820	881.820
355	835.650	880.650	395	836.850	881.850
356	835.680	880.680	396	836.880	881.880
357	835.710	880.710	397	836.910	881.910
358	835.740	880.740	398	836.940	881.940
359	835.770	880.770	399	836.970	881.970
360	835.800	880.800	400	837.000	882.000

Table G-1 Cellular Channels and Frequencies (Cont)

Channel Number	Mobile Transmit (MHz)	Mobile Receive (MHz)	Channel Number	Mobile Transmit (MHz)	Mobile Receive (MHz)
401	837.030	882.030	441	838.230	883.230
402	837.060	882.060	442	838.260	883.260
403	837.090	882.090	443	838.290	883.290
404	837.120	882.120	444	838.320	883.320
405	837.150	882.150	445	838.350	883.350
406	837.180	882.180	446	838.380	883.380
407	837.210	882.210	447	838.410	883.410
408	837.240	882.240	448	838.440	883.440
409	837.270	882.270	449	838.470	883.470
410	837.300	882.300	450	838.500	883.500
411	837.330	882.330	451	838.530	883.530
412	837.360	882.360	452	838.560	883.560
413	837.390	882.390	453	838.590	883.590
414	837.420	882.420	454	838.620	883.620
415	837.450	882.450	455	838.650	883.650
416	837.480	882.480	456	838.680	883.680
417	837.510	882.510	457	838.710	883.710
418	837.540	882.540	458	838.740	883.740
419	837.570	882.570	459	838.770	883.770
420	837.600	882.600	460	838.800	883.800
421	837.630	882.630	461	838.830	883.830
422	837.660	882.660	462	838.860	883.860
423	837.690	882.690	463	838.890	883.890
424	837.720	882.720	464	838.920	883.920
425	837.750	882.750	465	838.950	883.950
426	837.780	882.780	466	838.980	883.980
427	837.810	882.810	467	839.010	884.010
428	837.840	882.840	468	839.040	884.040
429	837.870	882.870	469	839.070	884.070
430	837.900	882.900	470	839.100	884.100
431	837.930	882.930	471	839.130	884.130
432	837.960	882.960	472	839.160	884.160
433	837.990	882.990	473	839.190	884.190
434	838.020	883.020	474	839.220	884.220
435	838.050	883.050	475	839.250	884.250
436	838.080	883.080	476	839.280	884.280
437	838.110	883.110	477	839.310	884.310
438	838.140	883.140	478	839.340	884.340
439	838.170	883.170	479	839.370	884.370
440	838.200	883.200	480	839.400	884.400

Table G-1 Cellular Channels and Frequencies (Cont)

Channel Number	Mobile Transmit (MHz)	Mobile Receive (MHz)	Channel Number	Mobile Transmit (MHz)	Mobile Receive (MHz)
481	839.430	884.430	521	840.630	885.630
482	839.460	884.460	522	840.660	885.660
483	839.490	884.490	523	840.690	885.690
484	839.520	884.520	524	840.720	885.720
485	839.550	884.550	525	840.750	885.750
486	839.580	884.580	526	840.780	885.780
487	839.610	884.610	527	840.810	885.810
488	839.640	884.640	528	840.840	885.840
489	839.670	884.670	529	840.870	885.870
490	839.700	884.700	530	840.900	885.900
491	839.730	884.730	531	840.930	885.930
492	839.760	884.760	532	840.960	885.960
493	839.790	884.790	533	840.990	885.990
494	839.820	884.820	534	841.020	886.020
495	839.850	884.850	535	841.050	886.050
496	839.880	884.880	536	841.080	886.080
497	839.910	884.910	537	841.110	886.110
498	839.940	884.940	538	841.140	886.140
499	839.970	884.970	539	841.170	886.170
500	840.000	885.000	540	841.200	886.200
501	840.030	885.030	541	841.230	886.230
502	840.060	885.060	542	841.260	886.260
503	840.090	885.090	543	841.290	886.290
504	840.120	885.120	544	841.320	886.320
505	840.150	885.150	545	841.350	886.350
506	840.180	885.180	546	841.380	886.380
507	840.210	885.210	547	841.410	886.410
508	840.240	885.240	548	841.440	886.440
509	840.270	885.270	549	841.470	886.470
510	840.300	885.300	550	841.500	886.500
511	840.330	885.330	551	841.530	886.530
512	840.360	885.360	552	841.560	886.560
513	840.390	885.390	553	841.590	886.590
514	840.420	885.420	554	841.620	886.620
515	840.450	885.450	555	841.650	886.650
516	840.480	885.480	556	841.680	886.680
517	840.510	885.510	557	841.710	886.710
518	840.540	885.540	558	841.740	886.740
519	840.570	885.570	559	841.770	886.770
520	840.600	885.600	560	841.800	886.800

Table G-1 Cellular Channels and Frequencies (Cont)

Channel Number	Mobile Transmit (MHz)	Mobile Receive (MHz)	Channel Number	Mobile Transmit (MHz)	Mobile Receive (MHz)
561	841.830	886.830	601	843.030	888.030
562	841.860	886.860	602	843.060	888.060
563	841.890	886.890	603	843.090	888.090
564	841.920	886.920	604	843.120	888.120
565	841.950	886.950	605	843.150	888.150
566	841.980	886.980	606	843.180	888.180
567	842.010	887.010	607	843.210	888.210
568	842.040	887.040	608	843.240	888.240
569	842.070	887.070	609	843.270	888.270
570	842.100	887.100	610	843.300	888.300
571	842.130	887.130	611	843.330	888.330
572	842.160	887.160	612	843.360	888.360
573	842.190	887.190	613	843.390	888.390
574	842.220	887.220	614	843.420	888.420
575	842.250	887.250	615	843.450	888.450
576	842.280	887.280	616	843.480	888.480
577	842.310	887.310	617	843.510	888.510
578	842.340	887.340	618	843.540	888.540
579	842.370	887.370	619	843.570	888.570
580	842.400	887.400	620	843.600	888.600
581	842.430	887.430	621	843.630	888.630
582	842.460	887.460	622	843.660	888.660
583	842.490	887.490	623	843.690	888.690
584	842.520	887.520	624	843.720	888.720
585	842.550	887.550	625	843.750	888.750
586	842.580	887.580	626	843.780	888.780
587	842.610	887.610	627	843.810	888.810
588	842.640	887.640	628	843.840	888.840
589	842.670	887.670	629	843.870	888.870
590	842.700	887.700	630	843.900	888.900
591	842.730	887.730	631	843.930	888.930
592	842.760	887.760	632	843.960	888.960
593	842.790	887.790	633	843.990	888.990
594	842.820	887.820	634	844.020	889.020
595	842.850	887.850	635	844.050	889.050
596	842.880	887.880	636	844.080	889.080
597	842.910	887.910	637	844.110	889.110
598	842.940	887.940	638	844.140	889.140
599	842.970	887.970	639	844.170	889.170
600	843.000	888.000	640	844.200	889.200

Table G-1 Cellular Channels and Frequencies (Cont)

Channel Number	Mobile Transmit (MHz)	Mobile Receive (MHz)	Channel Number	Mobile Transmit (MHz)	Mobile Receive (MHz)
641	844.230	889.230	681	845.430	890.430
642	844.260	889.260	682	845.460	890.460
643	844.290	889.290	683	845.490	890.490
644	844.320	889.320	684	845.520	890.520
645	844.350	889.350	685	845.550	890.550
646	844.380	889.380	686	845.580	890.580
647	844.410	889.410	687	845.610	890.610
648	844.440	889.440	688	845.640	890.640
649	844.470	889.470	689	845.670	890.670
650	844.500	889.500	690	845.700	890.700
651	844.530	889.530	691	845.730	890.730
652	844.560	889.560	692	845.760	890.760
653	844.590	889.590	693	845.790	890.790
654	844.620	889.620	694	845.820	890.820
655	844.650	889.650	695	845.850	890.850
656	844.680	889.680	696	845.880	890.880
657	844.710	889.710	697	845.910	890.910
658	844.740	889.740	698	845.940	890.940
659	844.770	889.770	699	845.970	890.970
660	844.800	889.800	700	846.000	891.000
661	844.830	889.830	701	846.030	891.030
662	844.860	889.860	702	846.060	891.060
663	844.890	889.890	703	846.090	891.090
664	844.920	889.920	704	846.120	891.120
665	844.950	889.950	705	846.150	891.150
666	844.980	889.980	706	846.180	891.180
667	845.010	890.010	707	846.210	891.210
668	845.040	890.040	708	846.240	891.240
669	845.070	890.070	709	846.270	891.270
670	845.100	890.100	710	846.300	891.300
671	845.130	890.130	711	846.330	891.330
672	845.160	890.160	712	846.360	891.360
673	845.190	890.190	713	846.390	891.390
674	845.220	890.220	714	846.420	891.420
675	845.250	890.250	715	846.450	891.450
676	845.280	890.280	716	846.480	891.480
677	845.310	890.310	717	846.510	891.510
678	845.340	890.340	718	846.540	891.540
679	845.370	890.370	719	846.570	891.570
680	845.400	890.400	720	846.600	891.600

Table G-1 Cellular Channels and Frequencies (Cont)

Channel Number	Mobile Transmit (MHz)	Mobile Receive (MHz)	Channel Number	Mobile Transmit (MHz)	Mobile Receive (MHz)
721	846.630	891.630	761	847.830	892.830
722	846.660	891.660	762	847.860	892.860
723	846.690	891.690	763	847.890	892.890
724	846.720	891.720	764	847.920	892.920
725	846.750	891.750	765	847.950	892.950
726	846.780	891.780	766	847.980	892.980
727	846.810	891.810	767	848.010	893.010
728	846.840	891.840	768	848.040	893.040
729	846.870	891.870	769	848.070	893.070
730	846.900	891.900	770	848.100	893.100
731	846.930	891.930	771	848.130	893.130
732	846.960	891.960	772	848.160	893.160
733	846.990	891.990	773	848.190	893.190
734	847.020	892.020	774	848.220	893.220
735	847.050	892.050	775	848.250	893.250
736	847.080	892.080	776	848.280	893.280
737	847.110	892.110	777	848.310	893.310
738	847.140	892.140	778	848.340	893.340
739	847.170	892.170	779	848.370	893.370
740	847.200	892.200	780	848.400	893.400
741	847.230	892.230	781	848.430	893.430
742	847.260	892.260	782	848.460	893.460
743	847.290	892.290	783	848.490	893.490
744	847.320	892.320	784	848.520	893.520
745	847.350	892.350	785	848.550	893.550
746	847.380	892.380	786	848.580	893.580
747	847.410	892.410	787	848.610	893.610
748	847.440	892.440	788	848.640	893.640
749	847.470	892.470	789	848.670	893.670
750	847.500	892.500	790	848.700	893.700
751	847.530	892.530	791	848.730	893.730
752	847.560	892.560	792	848.760	893.760
753	847.590	892.590	793	848.790	893.790
754	847.620	892.620	794	848.820	893.820
755	847.650	892.650	795	848.850	893.850
756	847.680	892.680	796	848.880	893.880
757	847.710	892.710	797	848.910	893.910
758	847.740	892.740	798	848.940	893.940
759	847.770	892.770	799	848.970	893.970
760	847.800	892.800			

Table G-1 Cellular Channels and Frequencies (Cont)

Channel Number	Mobile Transmit (MHz)	Mobile Receive (MHz)	Channel Number	Mobile Transmit (MHz)	Mobile Receive (MHz)
NOTE					
Channel Numbers 800 through 866 are not presently assigned to any Cellular Telephone System.					
800	849.000	894.000	831	849.930	894.930
801	849.030	894.030	832	849.960	894.960
802	849.060	894.060	833	849.990	894.990
803	849.090	894.090	834	850.020	895.020
804	849.120	894.120	835	850.050	895.050
805	849.150	894.150	836	850.080	895.080
806	849.180	894.180	837	850.110	895.110
807	849.210	894.210	838	850.140	895.140
808	849.240	894.240	839	850.170	895.170
809	849.270	894.270	840	850.200	895.200
810	849.300	894.300	841	850.230	895.230
811	849.330	894.330	842	850.260	895.260
812	849.360	894.360	843	850.290	895.290
813	849.390	894.390	844	850.320	895.320
814	849.420	894.420	845	850.350	895.350
815	849.450	894.450	846	850.380	895.380
816	849.480	894.480	847	850.410	895.410
817	849.510	894.510	848	850.440	895.440
818	849.540	894.540	849	850.470	895.470
819	849.570	894.570	850	850.500	895.500
820	849.600	894.600	851	850.530	895.530
821	849.630	894.630	852	850.560	895.560
822	849.660	894.660	853	850.590	895.590
823	849.690	894.690	854	850.620	895.620
824	849.720	894.720	855	850.650	895.650
825	849.750	894.750	856	850.680	895.680
826	849.780	894.780	857	850.710	895.710
827	849.810	894.810	858	850.740	895.740
828	849.840	894.840	859	850.770	895.770
829	849.870	894.870	860	850.800	895.800
830	849.900	894.900	861	850.830	895.830
			862	850.860	895.860
			863	850.890	895.890
			864	850.920	895.920
			865	850.950	895.950
			866	850.980	895.980

Table G-1 Cellular Channels and Frequencies (Cont)

Channel Number	Mobile Transmit (MHz)	Mobile Receive (MHz)
NOTE		
Frequencies for Channel Numbers 867 through 989 are not assigned and are not used by Cellular Telephone Systems. Channel Number 990 is not assigned to any system.		
991	824.040	869.040
992	824.070	869.070
993	824.100	869.100
994	824.130	869.130
995	824.160	869.160
996	824.190	869.190
997	824.220	869.220
998	824.250	869.250
999	824.280	869.280
1000	824.310	869.310
1001	824.340	869.340
1002	824.370	869.370
1003	824.400	869.400

Channel Number	Mobile Transmit (MHz)	Mobile Receive (MHz)
1004	824.430	869.430
1005	824.460	869.460
1006	824.490	869.490
1007	824.520	869.520
1008	824.550	869.550
1009	824.580	869.580
1010	824.610	869.610
1011	824.640	869.640
1012	824.670	869.670
1013	824.700	869.700
1014	824.730	869.730
1015	824.760	869.760
1016	824.790	869.790
1017	824.820	869.820
1018	824.850	869.850
1019	824.880	869.880
1020	824.910	869.910
1021	824.940	869.940
1022	824.970	869.970
1023	825.000	870.000

Table G-1 Cellular Channels and Frequencies (Cont)

**APPENDIX H — ENHANCED TOTAL ACCESS COMMUNICATIONS SYSTEM
(E-TACS) CELLULAR TELEPHONE CHANNEL NUMBERS
AND ASSIGNED CENTER FREQUENCIES**

Channel Number	Mobile Transmit (MHz)	Mobile Receive (MHz)	Channel Number	Mobile Transmit (MHz)	Mobile Receive (MHz)
0	889.9875	934.9875	44	891.0875	936.0875
1	890.0125	935.0125	45	891.1125	936.1125
2	890.0375	935.0375	46	891.1375	936.1375
3	890.0625	935.0625	47	891.1625	936.1625
4	890.0875	935.0875	48	891.1875	936.1875
5	890.1125	935.1125	49	891.2125	936.2125
6	890.1375	935.1375	50	891.2375	936.2375
7	890.1625	935.1625	51	891.2625	936.2625
8	890.1875	935.1875	52	891.2875	936.2875
9	890.2125	935.2125	53	891.3125	936.3125
10	890.2375	935.2375	54	891.3375	936.3375
11	890.2625	935.2625	55	891.3625	936.3625
12	890.2875	935.2875	56	891.3875	936.3875
13	890.3125	935.3125	57	891.4125	936.4125
14	890.3375	935.3375	58	891.4375	936.4375
15	890.3625	935.3625	59	891.4625	936.4625
16	890.3875	935.3875	60	891.4875	936.4875
17	890.4125	935.4125	61	891.5125	936.5125
18	890.4375	935.4375	62	891.5375	936.5375
19	890.4625	935.4625	63	891.5625	936.5625
20	890.4875	935.4875	64	891.5875	936.5875
21	890.5125	935.5125	65	891.6125	936.6125
22	890.5375	935.5375	66	891.6375	936.6375
23	890.5625	935.5625	67	891.6625	936.6625
24	890.5875	935.5875	68	891.6875	936.6875
25	890.6125	935.6125	69	891.7125	936.7125
26	890.6375	935.6375	70	891.7375	936.7375
27	890.6625	935.6625	71	891.7625	936.7625
28	890.6875	935.6875	72	891.7875	936.7875
29	890.7125	935.7125	73	891.8125	936.8125
30	890.7375	935.7375	74	891.8375	936.8375
31	890.7625	935.7625	75	891.8625	936.8625
32	890.7875	935.7875	76	891.8875	936.8875
33	890.8125	935.8125	77	891.9125	936.9125
34	890.8375	935.8375	78	891.9375	936.9375
35	890.8625	935.8625	79	891.9625	936.9625
36	890.8875	935.8875	80	891.9875	936.9875
37	890.9125	935.9125	81	892.0125	937.0125
38	890.9375	935.9375	82	892.0375	937.0375
39	890.9625	935.9625	83	892.0625	937.0625
40	890.9875	935.9875	84	892.0875	937.0875
41	891.0125	936.0125	85	892.1125	937.1125
42	891.0375	936.0375	86	892.1375	937.1375
43	891.0625	936.0625	87	892.1625	937.1625

Table H-1 E-TACS Cellular Channel Numbers and Frequencies

Channel Number	Mobile Transmit (MHz)	Mobile Receive (MHz)	Channel Number	Mobile Transmit (MHz)	Mobile Receive (MHz)
88	892.1875	937.1875	132	893.2875	938.2875
89	892.2125	937.2125	133	893.3125	938.3125
90	892.2375	937.2375	134	893.3375	938.3375
91	892.2625	937.2625	135	893.3625	938.3625
92	892.2875	937.2875	136	893.3875	938.3875
93	892.3125	937.3125	137	893.4125	938.4125
94	892.3375	937.3375	138	893.4375	938.4375
95	892.3625	937.3625	139	893.4625	938.4625
96	892.3875	937.3875	140	893.4875	938.4875
97	892.4125	937.4125	141	893.5125	938.5125
98	892.4375	937.4375	142	893.5375	938.5375
99	892.4625	937.4625	143	893.5625	938.5625
100	892.4875	937.4875	144	893.5875	938.5875
101	892.5125	937.5125	145	893.6125	938.6125
102	892.5375	937.5375	146	893.6375	938.6375
103	892.5625	937.5625	147	893.6625	938.6625
104	892.5875	937.5875	148	893.6875	938.6875
105	892.6125	937.6125	149	893.7125	938.7125
106	892.6375	937.6375	150	893.7375	938.7375
107	892.6625	937.6625	151	893.7625	938.7625
108	892.6875	937.6875	152	893.7875	938.7875
109	892.7125	937.7125	153	893.8125	938.8125
110	892.7375	937.7375	154	893.8375	938.8375
111	892.7625	937.7625	155	893.8625	938.8625
112	892.7875	937.7875	156	893.8875	938.8875
113	892.8125	937.8125	157	893.9125	938.9125
114	892.8375	937.8375	158	893.9375	938.9375
115	892.8625	937.8625	159	893.9625	938.9625
116	892.8875	937.8875	160	893.9875	938.9875
117	892.9125	937.9125	161	894.0125	939.0125
118	892.9375	937.9375	162	894.0375	939.0375
119	892.9625	937.9625	163	894.0625	939.0625
120	892.9875	937.9875	164	894.0875	939.0875
121	893.0125	938.0125	165	894.1125	939.1125
122	893.0375	938.0375	166	894.1375	939.1375
123	893.0625	938.0625	167	894.1625	939.1625
124	893.0875	938.0875	168	894.1875	939.1875
125	893.1125	938.1125	169	894.2125	939.2125
126	893.1375	938.1375	170	894.2375	939.2375
127	893.1625	938.1625	171	894.2625	939.2625
128	893.1875	938.1875	172	894.2875	939.2875
129	893.2125	938.2125	173	894.3125	939.3125
130	893.2375	938.2375	174	894.3375	939.3375
131	893.2625	938.2625	175	894.3625	939.3625

Table H-1 E-TACS Cellular Channel Numbers and Frequencies (Cont)

Channel Number	Mobile Transmit (MHz)	Mobile Receive (MHz)	Channel Number	Mobile Transmit (MHz)	Mobile Receive (MHz)
176	894.3875	939.3875	220	895.4875	940.4875
177	894.4125	939.4125	221	895.5125	940.5125
178	894.4375	939.4375	222	895.5375	940.5375
179	894.4625	939.4625	223	895.5625	940.5625
180	894.4875	939.4875	224	895.5875	940.5875
181	894.5125	939.5125	225	895.6125	940.6125
182	894.5375	939.5375	226	895.6375	940.6375
183	894.5625	939.5625	227	895.6625	940.6625
184	894.5875	939.5875	228	895.6875	940.6875
185	894.6125	939.6125	229	895.7125	940.7125
186	894.6375	939.6375	230	895.7375	940.7375
187	894.6625	939.6625	231	895.7625	940.7625
188	894.6875	939.6875	232	895.7875	940.7875
189	894.7125	939.7125	233	895.8125	940.8125
190	894.7375	939.7375	234	895.8375	940.8375
191	894.7625	939.7625	235	895.8625	940.8625
192	894.7875	939.7875	236	895.8875	940.8875
193	894.8125	939.8125	237	895.9125	940.9125
194	894.8375	939.8375	238	895.9375	940.9375
195	894.8625	939.8625	239	895.9625	940.9625
196	894.8875	939.8875	240	895.9875	940.9875
197	894.9125	939.9125	241	896.0125	941.0125
198	894.9375	939.9375	242	896.0375	941.0375
199	894.9625	939.9625	243	896.0625	941.0625
200	894.9875	939.9875	244	896.0875	941.0875
201	895.0125	940.0125	245	896.1125	941.1125
202	895.0375	940.0375	246	896.1375	941.1375
203	895.0625	940.0625	247	896.1625	941.1625
204	895.0875	940.0875	248	896.1875	941.1875
205	895.1125	940.1125	249	896.2125	941.2125
206	895.1375	940.1375	250	896.2375	941.2375
207	895.1625	940.1625	251	896.2625	941.2625
208	895.1875	940.1875	252	896.2875	941.2875
209	895.2125	940.2125	253	896.3125	941.3125
210	895.2375	940.2375	254	896.3375	941.3375
211	895.2625	940.2625	255	896.3625	941.3625
212	895.2875	940.2875	256	896.3875	941.3875
213	895.3125	940.3125	257	896.4125	941.4125
214	895.3375	940.3375	258	896.4375	941.4375
215	895.3625	940.3625	259	896.4625	941.4625
216	895.3875	940.3875	260	896.4875	941.4875
217	895.4125	940.4125	261	896.5125	941.5125
218	895.4375	940.4375	262	896.5375	941.5375
219	895.4625	940.4625	263	896.5625	941.5625

Table H-1 E-TACS Cellular Channel Numbers and Frequencies (Cont)

Channel Number	Mobile Transmit (MHz)	Mobile Receive (MHz)	Channel Number	Mobile Transmit (MHz)	Mobile Receive (MHz)
264	896.5875	941.5875	308	897.6875	942.6875
265	896.6125	941.6125	309	897.7125	942.7125
266	896.6375	941.6375	310	897.7375	942.7375
267	896.6625	941.6625	311	897.7625	942.7625
268	896.6875	941.6875	312	897.7875	942.7875
269	896.7125	941.7125	313	897.8125	942.8125
270	896.7375	941.7375	314	897.8375	942.8375
271	896.7625	941.7625	315	897.8625	942.8625
272	896.7875	941.7875	316	897.8875	942.8875
273	896.8125	941.8125	317	897.9125	942.9125
274	896.8375	941.8375	318	897.9375	942.9375
275	896.8625	941.8625	319	897.9625	942.9625
276	896.8875	941.8875	320	897.9875	942.9875
277	896.9125	941.9125	321	898.0125	943.0125
278	896.9375	941.9375	322	898.0375	943.0375
279	896.9625	941.9625	323	898.0625	943.0625
280	896.9875	941.9875	324	898.0875	943.0875
281	897.0125	942.0125	325	898.1125	943.1125
282	897.0375	942.0375	326	898.1375	943.1375
283	897.0625	942.0625	327	898.1625	943.1625
284	897.0875	942.0875	328	898.1875	943.1875
285	897.1125	942.1125	329	898.2125	943.2125
286	897.1375	942.1375	330	898.2375	943.2375
287	897.1625	942.1625	331	898.2625	943.2625
288	897.1875	942.1875	332	898.2875	943.2875
289	897.2125	942.2125	333	898.3125	943.3125
290	897.2375	942.2375	334	898.3375	943.3375
291	897.2625	942.2625	335	898.3625	943.3625
292	897.2875	942.2875	336	898.3875	943.3875
293	897.3125	942.3125	337	898.4125	943.4125
294	897.3375	942.3375	338	898.4375	943.4375
295	897.3625	942.3625	339	898.4625	943.4625
296	897.3875	942.3875	340	898.4875	943.4875
297	897.4125	942.4125	341	898.5125	943.5125
298	897.4375	942.4375	342	898.5375	943.5375
299	897.4625	942.4625	343	898.5625	943.5625
300	897.4875	942.4875	344	898.5875	943.5875
301	897.5125	942.5125	345	898.6125	943.6125
302	897.5375	942.5375	346	898.6375	943.6375
303	897.5625	942.5625	347	898.6625	943.6625
304	897.5875	942.5875	348	898.6875	943.6875
305	897.6125	942.6125	349	898.7125	943.7125
306	897.6375	942.6375	350	898.7375	943.7375
307	897.6625	942.6625	351	898.7625	943.7625

Table H-1 E-TACS Cellular Channel Numbers and Frequencies (Cont)

Channel Number	Mobile Transmit (MHz)	Mobile Receive (MHz)	Channel Number	Mobile Transmit (MHz)	Mobile Receive (MHz)
352	898.7875	943.7875	396	899.8875	944.8875
353	898.8125	943.8125	397	899.9125	944.9125
354	898.8375	943.8375	398	899.9375	944.9375
355	898.8625	943.8625	399	899.9625	944.9625
356	898.8875	943.8875	400	899.9875	944.9875
357	898.9125	943.9125	401	900.0125	945.0125
358	898.9375	943.9375	402	900.0375	945.0375
359	898.9625	943.9625	403	900.0625	945.0625
360	898.9875	943.9875	404	900.0875	945.0875
361	899.0125	944.0125	405	900.1125	945.1125
362	899.0375	944.0375	406	900.1375	945.1375
363	899.0625	944.0625	407	900.1625	945.1625
364	899.0875	944.0875	408	900.1875	945.1875
365	899.1125	944.1125	409	900.2125	945.2125
366	899.1375	944.1375	410	900.2375	945.2375
367	899.1625	944.1625	411	900.2625	945.2625
368	899.1875	944.1875	412	900.2875	945.2875
369	899.2125	944.2125	413	900.3125	945.3125
370	899.2375	944.2375	414	900.3375	945.3375
371	899.2625	944.2625	415	900.3625	945.3625
372	899.2875	944.2875	416	900.3875	945.3875
373	899.3125	944.3125	417	900.4125	945.4125
374	899.3375	944.3375	418	900.4375	945.4375
375	899.3625	944.3625	419	900.4625	945.4625
376	899.3875	944.3875	420	900.4875	945.4875
377	899.4125	944.4125	421	900.5125	945.5125
378	899.4375	944.4375	422	900.5375	945.5375
379	899.4625	944.4625	423	900.5625	945.5625
380	899.4875	944.4875	424	900.5875	945.5875
381	899.5125	944.5125	425	900.6125	945.6125
382	899.5375	944.5375	426	900.6375	945.6375
383	899.5625	944.5625	427	900.6625	945.6625
384	899.5875	944.5875	428	900.6875	945.6875
385	899.6125	944.6125	429	900.7125	945.7125
386	899.6375	944.6375	430	900.7375	945.7375
387	899.6625	944.6625	431	900.7625	945.7625
388	899.6875	944.6875	432	900.7875	945.7875
389	899.7125	944.7125	433	900.8125	945.8125
390	899.7375	944.7375	434	900.8375	945.8375
391	899.7625	944.7625	435	900.8625	945.8625
392	899.7875	944.7875	436	900.8875	945.8875
393	899.8125	944.8125	437	900.9125	945.9125
394	899.8375	944.8375	438	900.9375	945.9375
395	899.8625	944.8625	439	900.9625	945.9625

Table H-1 E-TACS Cellular Channel Numbers and Frequencies (Cont)

Channel Number	Mobile Transmit (MHz)	Mobile Receive (MHz)	Channel Number	Mobile Transmit (MHz)	Mobile Receive (MHz)
440	900.9875	945.9875	484	902.0875	947.0875
441	901.0125	946.0125	485	902.1125	947.1125
442	901.0375	946.0375	486	902.1375	947.1375
443	901.0625	946.0625	487	902.1625	947.1625
444	901.0875	946.0875	488	902.1875	947.1875
445	901.1125	946.1125	489	902.2125	947.2125
446	901.1375	946.1375	490	902.2375	947.2375
447	901.1625	946.1625	491	902.2625	947.2625
448	901.1875	946.1875	492	902.2875	947.2875
449	901.2125	946.2125	493	902.3125	947.3125
450	901.2375	946.2375	494	902.3375	947.3375
451	901.2625	946.2625	495	902.3625	947.3625
452	901.2875	946.2875	496	902.3875	947.3875
453	901.3125	946.3125	497	902.4125	947.4125
454	901.3375	946.3375	498	902.4375	947.4375
455	901.3625	946.3625	499	902.4625	947.4625
456	901.3875	946.3875	500	902.4875	947.4875
457	901.4125	946.4125	501	902.5125	947.5125
458	901.4375	946.4375	502	902.5375	947.5375
459	901.4625	946.4625	503	902.5625	947.5625
460	901.4875	946.4875	504	902.5875	947.5875
461	901.5125	946.5125	505	902.6125	947.6125
462	901.5375	946.5375	506	902.6375	947.6375
463	901.5625	946.5625	507	902.6625	947.6625
464	901.5875	946.5875	508	902.6875	947.6875
465	901.6125	946.6125	509	902.7125	947.7125
466	901.6375	946.6375	510	902.7375	947.7375
467	901.6625	946.6625	511	902.7625	947.7625
468	901.6875	946.6875	512	902.7875	947.7875
469	901.7125	946.7125	513	902.8125	947.8125
470	901.7375	946.7375	514	902.8375	947.8375
471	901.7625	946.7625	515	902.8625	947.8625
472	901.7875	946.7875	516	902.8875	947.8875
473	901.8125	946.8125	517	902.9125	947.9125
474	901.8375	946.8375	518	902.9375	947.9375
475	901.8625	946.8625	519	902.9625	947.9625
476	901.8875	946.8875	520	902.9875	947.9875
477	901.9125	946.9125	521	903.0125	948.0125
478	901.9375	946.9375	522	903.0375	948.0375
479	901.9625	946.9625	523	903.0625	948.0625
480	901.9875	946.9875	524	903.0875	948.0875
481	902.0125	947.0125	525	903.1125	948.1125
482	902.0375	947.0375	526	903.1375	948.1375
483	902.0625	947.0625	527	903.1625	948.1625

Table H-1 E-TACS Cellular Channel Numbers and Frequencies (Cont)

Channel Number	Mobile Transmit (MHz)	Mobile Receive (MHz)	Channel Number	Mobile Transmit (MHz)	Mobile Receive (MHz)
528	903.1875	948.1875	572	904.2875	949.2875
529	903.2125	948.2125	573	904.3125	949.3125
530	903.2375	948.2375	574	904.3375	949.3375
531	903.2625	948.2625	575	904.3625	949.3625
532	903.2875	948.2875	576	904.3875	949.3875
533	903.3125	948.3125	577	904.4125	949.4125
534	903.3375	948.3375	578	904.4375	949.4375
535	903.3625	948.3625	579	904.4625	949.4625
536	903.3875	948.3875	580	904.4875	949.4875
537	903.4125	948.4125	581	904.5125	949.5125
538	903.4375	948.4375	582	904.5375	949.5375
539	903.4625	948.4625	583	904.5625	949.5625
540	903.4875	948.4875	584	904.5875	949.5875
541	903.5125	948.5125	585	904.6125	949.6125
542	903.5375	948.5375	586	904.6375	949.6375
543	903.5625	948.5625	587	904.6625	949.6625
544	903.5875	948.5875	588	904.6875	949.6875
545	903.6125	948.6125	589	904.7125	949.7125
546	903.6375	948.6375	590	904.7375	949.7375
547	903.6625	948.6625	591	904.7625	949.7625
548	903.6875	948.6875	592	904.7875	949.7875
549	903.7125	948.7125	593	904.8125	949.8125
550	903.7375	948.7375	594	904.8375	949.8375
551	903.7625	948.7625	595	904.8625	949.8625
552	903.7875	948.7875	596	904.8875	949.8875
553	903.8125	948.8125	597	904.9125	949.9125
554	903.8375	948.8375	598	904.9375	949.9375
555	903.8625	948.8625	599	904.9625	949.9625
556	903.8875	948.8875	600	904.9875	949.9875
557	903.9125	948.9125	601	905.0125	950.0125
558	903.9375	948.9375	602	905.0375	950.0375
559	903.9625	948.9625	603	905.0625	950.0625
560	903.9875	948.9875	604	905.0875	950.0875
561	904.0125	949.0125	605	905.1125	950.1125
562	904.0375	949.0375	606	905.1375	950.1375
563	904.0625	949.0625	607	905.1625	950.1625
564	904.0875	949.0875	608	905.1875	950.1875
565	904.1125	949.1125	609	905.2125	950.2125
566	904.1375	949.1375	610	905.2375	950.2375
567	904.1625	949.1625	611	905.2625	950.2625
568	904.1875	949.1875	612	905.2875	950.2875
569	904.2125	949.2125	613	905.3125	950.3125
570	904.2375	949.2375	614	905.3375	950.3375
571	904.2625	949.2625	615	905.3625	950.3625

Table H-1 E-TACS Cellular Channel Numbers and Frequencies (Cont)

Channel Number	Mobile Transmit (MHz)	Mobile Receive (MHz)	Channel Number	Mobile Transmit (MHz)	Mobile Receive (MHz)
616	905.3875	950.3875	660	906.4875	951.4875
617	905.4125	950.4125	661	906.5125	951.5125
618	905.4375	950.4375	662	906.5375	951.5375
619	905.4625	950.4625	663	906.5625	951.5625
620	905.4875	950.4875	664	906.5875	951.5875
621	905.5125	950.5125	665	906.6125	951.6125
622	905.5375	950.5375	666	906.6375	951.6375
623	905.5625	950.5625	667	906.6625	951.6625
624	905.5875	950.5875	668	906.6875	951.6875
625	905.6125	950.6125	669	906.7125	951.7125
626	905.6375	950.6375	670	906.7375	951.7375
627	905.6625	950.6625	671	906.7625	951.7625
628	905.6875	950.6875	672	906.7875	951.7875
629	905.7125	950.7125	673	906.8125	951.8125
630	905.7375	950.7375	674	906.8375	951.8375
631	905.7625	950.7625	675	906.8625	951.8625
632	905.7875	950.7875	676	906.8875	951.8875
633	905.8125	950.8125	677	906.9125	951.9125
634	905.8375	950.8375	678	906.9375	951.9375
635	905.8625	950.8625	679	906.9625	951.9625
636	905.8875	950.8875	680	906.9875	951.9875
637	905.9125	950.9125	681	907.0125	952.0125
638	905.9375	950.9375	682	907.0375	952.0375
639	905.9625	950.9625	683	907.0625	952.0625
640	905.9875	950.9875	684	907.0875	952.0875
641	906.0125	951.0125	685	907.1125	952.1125
642	906.0375	951.0375	686	907.1375	952.1375
643	906.0625	951.0625	687	907.1625	952.1625
644	906.0875	951.0875	688	907.1875	952.1875
645	906.1125	951.1125	689	907.2125	952.2125
646	906.1375	951.1375	690	907.2375	952.2375
647	906.1625	951.1625	691	907.2625	952.2625
648	906.1875	951.1875	692	907.2875	952.2875
649	906.2125	951.2125	693	907.3125	952.3125
650	906.2375	951.2375	694	907.3375	952.3375
651	906.2625	951.2625	695	907.3625	952.3625
652	906.2875	951.2875	696	907.3875	952.3875
653	906.3125	951.3125	697	907.4125	952.4125
654	906.3375	951.3375	698	907.4375	952.4375
655	906.3625	951.3625	699	907.4625	952.4625
656	906.3875	951.3875	700	907.4875	952.4875
657	906.4125	951.4125	701	907.5125	952.5125
658	906.4375	951.4375	702	907.5375	952.5375
659	906.4625	951.4625	703	907.5625	952.5625

Table H-1 E-TACS Cellular Channel Numbers and Frequencies (Cont)

Channel Number	Mobile Transmit (MHz)	Mobile Receive (MHz)	Channel Number	Mobile Transmit (MHz)	Mobile Receive (MHz)
704	907.5875	952.5875	748	908.6875	953.6875
705	907.6125	952.6125	749	908.7125	953.7125
706	907.6375	952.6375	750	908.7375	953.7375
707	907.6625	952.6625	751	908.7625	953.7625
708	907.6875	952.6875	752	908.7875	953.7875
709	907.7125	952.7125	753	908.8125	953.8125
710	907.7375	952.7375	754	908.8375	953.8375
711	907.7625	952.7625	755	908.8625	953.8625
712	907.7875	952.7875	756	908.8875	953.8875
713	907.8125	952.8125	757	908.9125	953.9125
714	907.8375	952.8375	758	908.9375	953.9375
715	907.8625	952.8625	759	908.9625	953.9625
716	907.8875	952.8875	760	908.9875	953.9875
717	907.9125	952.9125	761	909.0125	954.0125
718	907.9375	952.9375	762	909.0375	954.0375
719	907.9625	952.9625	763	909.0625	954.0625
720	907.9875	952.9875	764	909.0875	954.0875
721	908.0125	953.0125	765	909.1125	954.1125
722	908.0375	953.0375	766	909.1375	954.1375
723	908.0625	953.0625	767	909.1625	954.1625
724	908.0875	953.0875	768	909.1875	954.1875
725	908.1125	953.1125	769	909.2125	954.2125
726	908.1375	953.1375	770	909.2375	954.2375
727	908.1625	953.1625	771	909.2625	954.2625
728	908.1875	953.1875	772	909.2875	954.2875
729	908.2125	953.2125	773	909.3125	954.3125
730	908.2375	953.2375	774	909.3375	954.3375
731	908.2625	953.2625	775	909.3625	954.3625
732	908.2875	953.2875	776	909.3875	954.3875
733	908.3125	953.3125	777	909.4125	954.4125
734	908.3375	953.3375	778	909.4375	954.4375
735	908.3625	953.3625	779	909.4625	954.4625
736	908.3875	953.3875	780	909.4875	954.4875
737	908.4125	953.4125	781	909.5125	954.5125
738	908.4375	953.4375	782	909.5375	954.5375
739	908.4625	953.4625	783	909.5625	954.5625
740	908.4875	953.4875	784	909.5875	954.5875
741	908.5125	953.5125	785	909.6125	954.6125
742	908.5375	953.5375	786	909.6375	954.6375
743	908.5625	953.5625	787	909.6625	954.6625
744	908.5875	953.5875	788	909.6875	954.6875
745	908.6125	953.6125	789	909.7125	954.7125
746	908.6375	953.6375	790	909.7375	954.7375
747	908.6625	953.6625	791	909.7625	954.7625

Table H-1 E-TACS Cellular Channel Numbers and Frequencies (Cont)

Channel Number	Mobile Transmit (MHz)	Mobile Receive (MHz)	Channel Number	Mobile Transmit (MHz)	Mobile Receive (MHz)
792	909.7875	954.7875	836	910.8875	955.8875
793	909.8125	954.8125	837	910.9125	955.9125
794	909.8375	954.8375	838	910.9375	955.9375
795	909.8625	954.8625	839	910.9625	955.9625
796	909.8875	954.8875	840	910.9875	955.9875
797	909.9125	954.9125	841	911.0125	956.0125
798	909.9375	954.9375	842	911.0375	956.0375
799	909.9625	954.9625	843	911.0625	956.0625
800	909.9875	954.9875	844	911.0875	956.0875
801	910.0125	955.0125	845	911.1125	956.1125
802	910.0375	955.0375	846	911.1375	956.1375
803	910.0625	955.0625	847	911.1625	956.1625
804	910.0875	955.0875	848	911.1875	956.1875
805	910.1125	955.1125	849	911.2125	956.2125
806	910.1375	955.1375	850	911.2375	956.2375
807	910.1625	955.1625	851	911.2625	956.2625
808	910.1875	955.1875	852	911.2875	956.2875
809	910.2125	955.2125	853	911.3125	956.3125
810	910.2375	955.2375	854	911.3375	956.3375
811	910.2625	955.2625	855	911.3625	956.3625
812	910.2875	955.2875	856	911.3875	956.3875
813	910.3125	955.3125	857	911.4125	956.4125
814	910.3375	955.3375	858	911.4375	956.4375
815	910.3625	955.3625	859	911.4625	956.4625
816	910.3875	955.3875	860	911.4875	956.4875
817	910.4125	955.4125	861	911.5125	956.5125
818	910.4375	955.4375	862	911.5375	956.5375
819	910.4625	955.4625	863	911.5625	956.5625
820	910.4875	955.4875	864	911.5875	956.5875
821	910.5125	955.5125	865	911.6125	956.6125
822	910.5375	955.5375	866	911.6375	956.6375
823	910.5625	955.5625	867	911.6625	956.6625
824	910.5875	955.5875	868	911.6875	956.6875
825	910.6125	955.6125	869	911.7125	956.7125
826	910.6375	955.6375	870	911.7375	956.7375
827	910.6625	955.6625	871	911.7625	956.7625
828	910.6875	955.6875	872	911.7875	956.7875
829	910.7125	955.7125	873	911.8125	956.8125
830	910.7375	955.7375	874	911.8375	956.8375
831	910.7625	955.7625	875	911.8625	956.8625
832	910.7875	955.7875	876	911.8875	956.8875
833	910.8125	955.8125	877	911.9125	956.9125
834	910.8375	955.8375	878	911.9375	956.9375
835	910.8625	955.8625	879	911.9625	956.9625

Table H-1 E-TACS Cellular Channel Numbers and Frequencies (Cont)

Channel Number	Mobile Transmit (MHz)	Mobile Receive (MHz)	Channel Number	Mobile Transmit (MHz)	Mobile Receive (MHz)
880	911.9875	956.9875	924	913.0875	958.0875
881	912.0125	957.0125	925	913.1125	958.1125
882	912.0375	957.0375	926	913.1375	958.1375
883	912.0625	957.0625	927	913.1625	958.1625
884	912.0875	957.0875	928	913.1875	958.1875
885	912.1125	957.1125	929	913.2125	958.2125
886	912.1375	957.1375	930	913.2375	958.2375
887	912.1625	957.1625	931	913.2625	958.2625
888	912.1875	957.1875	932	913.2875	958.2875
889	912.2125	957.2125	933	913.3125	958.3125
890	912.2375	957.2375	934	913.3375	958.3375
891	912.2625	957.2625	935	913.3625	958.3625
892	912.2875	957.2875	936	913.3875	958.3875
893	912.3125	957.3125	937	913.4125	958.4125
894	912.3375	957.3375	938	913.4375	958.4375
895	912.3625	957.3625	939	913.4625	958.4625
896	912.3875	957.3875	940	913.4875	958.4875
897	912.4125	957.4125	941	913.5125	958.5125
898	912.4375	957.4375	942	913.5375	958.5375
899	912.4625	957.4625	943	913.5625	958.5625
900	912.4875	957.4875	944	913.5875	958.5875
901	912.5125	957.5125	945	913.6125	958.6125
902	912.5375	957.5375	946	913.6375	958.6375
903	912.5625	957.5625	947	913.6625	958.6625
904	912.5875	957.5875	948	913.6875	958.6875
905	912.6125	957.6125	949	913.7125	958.7125
906	912.6375	957.6375	950	913.7375	958.7375
907	912.6625	957.6625	951	913.7625	958.7625
908	912.6875	957.6875	952	913.7875	958.7875
909	912.7125	957.7125	953	913.8125	958.8125
910	912.7375	957.7375	954	913.8375	958.8375
911	912.7625	957.7625	955	913.8625	958.8625
912	912.7875	957.7875	956	913.8875	958.8875
913	912.8125	957.8125	957	913.9125	958.9125
914	912.8375	957.8375	958	913.9375	958.9375
915	912.8625	957.8625	959	913.9625	958.9625
916	912.8875	957.8875	960	913.9875	958.9875
917	912.9125	957.9125	961	914.0125	959.0125
918	912.9375	957.9375	962	914.0375	959.0375
919	912.9625	957.9625	963	914.0625	959.0625
920	912.9875	957.9875	964	914.0875	959.0875
921	913.0125	958.0125	965	914.1125	959.1125
922	913.0375	958.0375	966	914.1375	959.1375
923	913.0625	958.0625	967	914.1625	959.1625

Table H-1 E-TACS Cellular Channel Numbers and Frequencies (Cont)

Channel Number	Mobile Transmit (MHz)	Mobile Receive (MHz)	Channel Number	Mobile Transmit (MHz)	Mobile Receive (MHz)
968	914.1875	959.1875	1331	872.0625	917.0625
969	914.2125	959.2125	1332	872.0875	917.0875
970	914.2375	959.2375	1333	872.1125	917.1125
971	914.2625	959.2625	1334	872.1375	917.1375
972	914.2875	959.2875	1335	872.1625	917.1625
973	914.3125	959.3125	1336	872.1875	917.1875
974	914.3375	959.3375	1337	872.2125	917.2125
975	914.3625	959.3625	1338	872.2375	917.2375
976	914.3875	959.3875	1339	872.2625	917.2625
977	914.4125	959.4125	1340	872.2875	917.2875
978	914.4375	959.4375	1341	872.3125	917.3125
979	914.4625	959.4625	1342	872.3375	917.3375
980	914.4875	959.4875	1343	872.3625	917.3625
981	914.5125	959.5125	1344	872.3875	917.3875
982	914.5375	959.5375	1345	872.4125	917.4125
983	914.5625	959.5625	1346	872.4375	917.4375
984	914.5875	959.5875	1347	872.4625	917.4625
985	914.6125	959.6125	1348	872.4875	917.4875
986	914.6375	959.6375	1349	872.5125	917.5125
987	914.6625	959.6625	1350	872.5375	917.5375
988	914.6875	959.6875	1351	872.5625	917.5625
989	914.7125	959.7125	1352	872.5875	917.5875
990	914.7375	959.7375	1353	872.6125	917.6125
991	914.7625	959.7625	1354	872.6375	917.6375
992	914.7875	959.7875	1355	872.6625	917.6625
993	914.8125	959.8125	1356	872.6875	917.6875
994	914.8375	959.8375	1357	872.7125	917.7125
995	914.8625	959.8625	1358	872.7375	917.7375
996	914.8875	959.8875	1359	872.7625	917.7625
997	914.9125	959.9125	1360	872.7875	917.7875
998	914.9375	959.9375	1361	872.8125	917.8125
999	914.9625	959.9625	1362	872.8375	917.8375
1000	914.9875	959.9875	1363	872.8625	917.8625
			1364	872.8875	917.8875
			1365	872.9125	917.9125
			1366	872.9375	917.9375
			1367	872.9625	917.9625
			1368	872.9875	917.9875
			1369	873.0125	918.0125
			1370	873.0375	918.0375
			1371	873.0625	918.0625
			1372	873.0875	918.0875
1329	872.0125	917.0125	1373	873.1125	918.1125
1330	872.0375	917.0375	1374	873.1375	918.1375

NOTE

Channel numbers 1001 through 1328 are currently unassigned.

TACS - Ch 1 - 1000

ETACS - Ch 1 - 600, 1329 - 2047

Table H-1 E-TACS Cellular Channel Numbers and Frequencies (Cont)

Channel Number	Mobile Transmit (MHz)	Mobile Receive (MHz)	Channel Number	Mobile Transmit (MHz)	Mobile Receive (MHz)
1375	873.1625	918.1625	1419	874.2625	919.2625
1376	873.1875	918.1875	1420	874.2875	919.2875
1377	873.2125	918.2125	1421	874.3125	919.3125
1378	873.2375	918.2375	1422	874.3375	919.3375
1379	873.2625	918.2625	1423	874.3625	919.3625
1380	873.2875	918.2875	1424	874.3875	919.3875
1381	873.3125	918.3125	1425	874.4125	919.4125
1382	873.3375	918.3375	1426	874.4375	919.4375
1383	873.3625	918.3625	1427	874.4625	919.4625
1384	873.3875	918.3875	1428	874.4875	919.4875
1385	873.4125	918.4125	1429	874.5125	919.5125
1386	873.4375	918.4375	1430	874.5375	919.5375
1387	873.4625	918.4625	1431	874.5625	919.5625
1388	873.4875	918.4875	1432	874.5875	919.5875
1389	873.5125	918.5125	1433	874.6125	919.6125
1390	873.5375	918.5375	1434	874.6375	919.6375
1391	873.5625	918.5625	1435	874.6625	919.6625
1392	873.5875	918.5875	1436	874.6875	919.6875
1393	873.6125	918.6125	1437	874.7125	919.7125
1394	873.6375	918.6375	1438	874.7375	919.7375
1395	873.6625	918.6625	1439	874.7625	919.7625
1396	873.6875	918.6875	1440	874.7875	919.7875
1397	873.7125	918.7125	1441	874.8125	919.8125
1398	873.7375	918.7375	1442	874.8375	919.8375
1399	873.7625	918.7625	1443	874.8625	919.8625
1400	873.7875	918.7875	1444	874.8875	919.8875
1401	873.8125	918.8125	1445	874.9125	919.9125
1402	873.8375	918.8375	1446	874.9375	919.9375
1403	873.8625	918.8625	1447	874.9625	919.9625
1404	873.8875	918.8875	1448	874.9875	919.9875
1405	873.9125	918.9125	1449	875.0125	920.0125
1406	873.9375	918.9375	1450	875.0375	920.0375
1407	873.9625	918.9625	1451	875.0625	920.0625
1408	873.9875	918.9875	1452	875.0875	920.0875
1409	874.0125	919.0125	1453	875.1125	920.1125
1410	874.0375	919.0375	1454	875.1375	920.1375
1411	874.0625	919.0625	1455	875.1625	920.1625
1412	874.0875	919.0875	1456	875.1875	920.1875
1413	874.1125	919.1125	1457	875.2125	920.2125
1414	874.1375	919.1375	1458	875.2375	920.2375
1415	874.1625	919.1625	1459	875.2625	920.2625
1416	874.1875	919.1875	1460	875.2875	920.2875
1417	874.2125	919.2125	1461	875.3125	920.3125
1418	874.2375	919.2375	1462	875.3375	920.3375

Table H-1 E-TACS Cellular Channel Numbers and Frequencies (Cont)

Channel Number	Mobile Transmit (MHz)	Mobile Receive (MHz)	Channel Number	Mobile Transmit (MHz)	Mobile Receive (MHz)
1463	875.3625	920.3625	1507	876.4625	921.4625
1464	875.3875	920.3875	1508	876.4875	921.4875
1465	875.4125	920.4125	1509	876.5125	921.5125
1466	875.4375	920.4375	1510	876.5375	921.5375
1467	875.4625	920.4625	1511	876.5625	921.5625
1468	875.4875	920.4875	1512	876.5875	921.5875
1469	875.5125	920.5125	1513	876.6125	921.6125
1470	875.5375	920.5375	1514	876.6375	921.6375
1471	875.5625	920.5625	1515	876.6625	921.6625
1472	875.5875	920.5875	1516	876.6875	921.6875
1473	875.6125	920.6125	1517	876.7125	921.7125
1474	875.6375	920.6375	1518	876.7375	921.7375
1475	875.6625	920.6625	1519	876.7625	921.7625
1476	875.6875	920.6875	1520	876.7875	921.7875
1477	875.7125	920.7125	1521	876.8125	921.8125
1478	875.7375	920.7375	1522	876.8375	921.8375
1479	875.7625	920.7625	1523	876.8625	921.8625
1480	875.7875	920.7875	1524	876.8875	921.8875
1481	875.8125	920.8125	1525	876.9125	921.9125
1482	875.8375	920.8375	1526	876.9375	921.9375
1483	875.8625	920.8625	1527	876.9625	921.9625
1484	875.8875	920.8875	1528	876.9875	921.9875
1485	875.9125	920.9125	1529	877.0125	922.0125
1486	875.9375	920.9375	1530	877.0375	922.0375
1487	875.9625	920.9625	1531	877.0625	922.0625
1488	875.9875	920.9875	1532	877.0875	922.0875
1489	876.0125	921.0125	1533	877.1125	922.1125
1490	876.0375	921.0375	1534	877.1375	922.1375
1491	876.0625	921.0625	1535	877.1625	922.1625
1492	876.0875	921.0875	1536	877.1875	922.1875
1493	876.1125	921.1125	1537	877.2125	922.2125
1494	876.1375	921.1375	1538	877.2375	922.2375
1495	876.1625	921.1625	1539	877.2625	922.2625
1496	876.1875	921.1875	1540	877.2875	922.2875
1497	876.2125	921.2125	1541	877.3125	922.3125
1498	876.2375	921.2375	1542	877.3375	922.3375
1499	876.2625	921.2625	1543	877.3625	922.3625
1500	876.2875	921.2875	1544	877.3875	922.3875
1501	876.3125	921.3125	1545	877.4125	922.4125
1502	876.3375	921.3375	1546	877.4375	922.4375
1503	876.3625	921.3625	1547	877.4625	922.4625
1504	876.3875	921.3875	1548	877.4875	922.4875
1505	876.4125	921.4125	1549	877.5125	922.5125
1506	876.4375	921.4375	1550	877.5375	922.5375

Table H-1 E-TACS Cellular Channel Numbers and Frequencies (Cont)

Channel Number	Mobile Transmit (MHz)	Mobile Receive (MHz)	Channel Number	Mobile Transmit (MHz)	Mobile Receive (MHz)
1551	877.5625	922.5625	1595	878.6625	923.6625
1552	877.5875	922.5875	1596	878.6875	923.6875
1553	877.6125	922.6125	1597	878.7125	923.7125
1554	877.6375	922.6375	1598	878.7375	923.7375
1555	877.6625	922.6625	1599	878.7625	923.7625
1556	877.6875	922.6875	1600	878.7875	923.7875
1557	877.7125	922.7125	1601	878.8125	923.8125
1558	877.7375	922.7375	1602	878.8375	923.8375
1559	877.7625	922.7625	1603	878.8625	923.8625
1560	877.7875	922.7875	1604	878.8875	923.8875
1561	877.8125	922.8125	1605	878.9125	923.9125
1562	877.8375	922.8375	1606	878.9375	923.9375
1563	877.8625	922.8625	1607	878.9625	923.9625
1564	877.8875	922.8875	1608	878.9875	923.9875
1565	877.9125	922.9125	1609	879.0125	924.0125
1566	877.9375	922.9375	1610	879.0375	924.0375
1567	877.9625	922.9625	1611	879.0625	924.0625
1568	877.9875	922.9875	1612	879.0875	924.0875
1569	878.0125	923.0125	1613	879.1125	924.1125
1570	878.0375	923.0375	1614	879.1375	924.1375
1571	878.0625	923.0625	1615	879.1625	924.1625
1572	878.0875	923.0875	1616	879.1875	924.1875
1573	878.1125	923.1125	1617	879.2125	924.2125
1574	878.1375	923.1375	1618	879.2375	924.2375
1575	878.1625	923.1625	1619	879.2625	924.2625
1576	878.1875	923.1875	1620	879.2875	924.2875
1577	878.2125	923.2125	1621	879.3125	924.3125
1578	878.2375	923.2375	1622	879.3375	924.3375
1579	878.2625	923.2625	1623	879.3625	924.3625
1580	878.2875	923.2875	1624	879.3875	924.3875
1581	878.3125	923.3125	1625	879.4125	924.4125
1582	878.3375	923.3375	1626	879.4375	924.4375
1583	878.3625	923.3625	1627	879.4625	924.4625
1584	878.3875	923.3875	1628	879.4875	924.4875
1585	878.4125	923.4125	1629	879.5125	924.5125
1586	878.4375	923.4375	1630	879.5375	924.5375
1587	878.4625	923.4625	1631	879.5625	924.5625
1588	878.4875	923.4875	1632	879.5875	924.5875
1589	878.5125	923.5125	1633	879.6125	924.6125
1590	878.5375	923.5375	1634	879.6375	924.6375
1591	878.5625	923.5625	1635	879.6625	924.6625
1592	878.5875	923.5875	1636	879.6875	924.6875
1593	878.6125	923.6125	1637	879.7125	924.7125
1594	878.6375	923.6375	1638	879.7375	924.7375

Table H-1 E-TACS Cellular Channel Numbers and Frequencies (Cont)

Channel Number	Mobile Transmit (MHz)	Mobile Receive (MHz)	Channel Number	Mobile Transmit (MHz)	Mobile Receive (MHz)
1639	879.7625	924.7625	1683	880.8625	925.8625
1640	879.7875	924.7875	1684	880.8875	925.8875
1641	879.8125	924.8125	1685	880.9125	925.9125
1642	879.8375	924.8375	1686	880.9375	925.9375
1643	879.8625	924.8625	1687	880.9625	925.9625
1644	879.8875	924.8875	1688	880.9875	925.9875
1645	879.9125	924.9125	1689	881.0125	926.0125
1646	879.9375	924.9375	1690	881.0375	926.0375
1647	879.9625	924.9625	1691	881.0625	926.0625
1648	879.9875	924.9875	1692	881.0875	926.0875
1649	880.0125	925.0125	1693	881.1125	926.1125
1650	880.0375	925.0375	1694	881.1375	926.1375
1651	880.0625	925.0625	1695	881.1625	926.1625
1652	880.0875	925.0875	1696	881.1875	926.1875
1653	880.1125	925.1125	1697	881.2125	926.2125
1654	880.1375	925.1375	1698	881.2375	926.2375
1655	880.1625	925.1625	1699	881.2625	926.2625
1656	880.1875	925.1875	1700	881.2875	926.2875
1657	880.2125	925.2125	1701	881.3125	926.3125
1658	880.2375	925.2375	1702	881.3375	926.3375
1659	880.2625	925.2625	1703	881.3625	926.3625
1660	880.2875	925.2875	1704	881.3875	926.3875
1661	880.3125	925.3125	1705	881.4125	926.4125
1662	880.3375	925.3375	1706	881.4375	926.4375
1663	880.3625	925.3625	1707	881.4625	926.4625
1664	880.3875	925.3875	1708	881.4875	926.4875
1665	880.4125	925.4125	1709	881.5125	926.5125
1666	880.4375	925.4375	1710	881.5375	926.5375
1667	880.4625	925.4625	1711	881.5625	926.5625
1668	880.4875	925.4875	1712	881.5875	926.5875
1669	880.5125	925.5125	1713	881.6125	926.6125
1670	880.5375	925.5375	1714	881.6375	926.6375
1671	880.5625	925.5625	1715	881.6625	926.6625
1672	880.5875	925.5875	1716	881.6875	926.6875
1673	880.6125	925.6125	1717	881.7125	926.7125
1674	880.6375	925.6375	1718	881.7375	926.7375
1675	880.6625	925.6625	1719	881.7625	926.7625
1676	880.6875	925.6875	1720	881.7875	926.7875
1677	880.7125	925.7125	1721	881.8125	926.8125
1678	880.7375	925.7375	1722	881.8375	926.8375
1679	880.7625	925.7625	1723	881.8625	926.8625
1680	880.7875	925.7875	1724	881.8875	926.8875
1681	880.8125	925.8125	1725	881.9125	926.9125
1682	880.8375	925.8375	1726	881.9375	926.9375

Table H-1 E-TACS Cellular Channel Numbers and Frequencies (Cont)

Channel Number	Mobile Transmit (MHz)	Mobile Receive (MHz)	Channel Number	Mobile Transmit (MHz)	Mobile Receive (MHz)
1727	881.9625	926.9625	1771	883.0625	928.0625
1728	881.9875	926.9875	1772	883.0875	928.0875
1729	882.0125	927.0125	1773	883.1125	928.1125
1730	882.0375	927.0375	1774	883.1375	928.1375
1731	882.0625	927.0625	1775	883.1625	928.1625
1732	882.0875	927.0875	1776	883.1875	928.1875
1733	882.1125	927.1125	1777	883.2125	928.2125
1734	882.1375	927.1375	1778	883.2375	928.2375
1735	882.1625	927.1625	1779	883.2625	928.2625
1736	882.1875	927.1875	1780	883.2875	928.2875
1737	882.2125	927.2125	1781	883.3125	928.3125
1738	882.2375	927.2375	1782	883.3375	928.3375
1739	882.2625	927.2625	1783	883.3625	928.3625
1740	882.2875	927.2875	1784	883.3875	928.3875
1741	882.3125	927.3125	1785	883.4125	928.4125
1742	882.3375	927.3375	1786	883.4375	928.4375
1743	882.3625	927.3625	1787	883.4625	928.4625
1744	882.3875	927.3875	1788	883.4875	928.4875
1745	882.4125	927.4125	1789	883.5125	928.5125
1746	882.4375	927.4375	1790	883.5375	928.5375
1747	882.4625	927.4625	1791	883.5625	928.5625
1748	882.4875	927.4875	1792	883.5875	928.5875
1749	882.5125	927.5125	1793	883.6125	928.6125
1750	882.5375	927.5375	1794	883.6375	928.6375
1751	882.5625	927.5625	1795	883.6625	928.6625
1752	882.5875	927.5875	1796	883.6875	928.6875
1753	882.6125	927.6125	1797	883.7125	928.7125
1754	882.6375	927.6375	1798	883.7375	928.7375
1755	882.6625	927.6625	1799	883.7625	928.7625
1756	882.6875	927.6875	1800	883.7875	928.7875
1757	882.7125	927.7125	1801	883.8125	928.8125
1758	882.7375	927.7375	1802	883.8375	928.8375
1759	882.7625	927.7625	1803	883.8625	928.8625
1760	882.7875	927.7875	1804	883.8875	928.8875
1761	882.8125	927.8125	1805	883.9125	928.9125
1762	882.8375	927.8375	1806	883.9375	928.9375
1763	882.8625	927.8625	1807	883.9625	928.9625
1764	882.8875	927.8875	1808	883.9875	928.9875
1765	882.9125	927.9125	1809	884.0125	929.0125
1766	882.9375	927.9375	1810	884.0375	929.0375
1767	882.9625	927.9625	1811	884.0625	929.0625
1768	882.9875	927.9875	1812	884.0875	929.0875
1769	883.0125	928.0125	1813	884.1125	929.1125
1770	883.0375	928.0375	1814	884.1375	929.1375

Table H-1 E-TACS Cellular Channel Numbers and Frequencies (Cont)

Channel Number	Mobile Transmit (MHz)	Mobile Receive (MHz)	Channel Number	Mobile Transmit (MHz)	Mobile Receive (MHz)
1815	884.1625	929.1625	1859	885.2625	930.2625
1816	884.1875	929.1875	1860	885.2875	930.2875
1817	884.2125	929.2125	1861	885.3125	930.3125
1818	884.2375	929.2375	1862	885.3375	930.3375
1819	884.2625	929.2625	1863	885.3625	930.3625
1820	884.2875	929.2875	1864	885.3875	930.3875
1821	884.3125	929.3125	1865	885.4125	930.4125
1822	884.3375	929.3375	1866	885.4375	930.4375
1823	884.3625	929.3625	1867	885.4625	930.4625
1824	884.3875	929.3875	1868	885.4875	930.4875
1825	884.4125	929.4125	1869	885.5125	930.5125
1826	884.4375	929.4375	1870	885.5375	930.5375
1827	884.4625	929.4625	1871	885.5625	930.5625
1828	884.4875	929.4875	1872	885.5875	930.5875
1829	884.5125	929.5125	1873	885.6125	930.6125
1830	884.5375	929.5375	1874	885.6375	930.6375
1831	884.5625	929.5625	1875	885.6625	930.6625
1832	884.5875	929.5875	1876	885.6875	930.6875
1833	884.6125	929.6125	1877	885.7125	930.7125
1834	884.6375	929.6375	1878	885.7375	930.7375
1835	884.6625	929.6625	1879	885.7625	930.7625
1836	884.6875	929.6875	1880	885.7875	930.7875
1837	884.7125	929.7125	1881	885.8125	930.8125
1838	884.7375	929.7375	1882	885.8375	930.8375
1839	884.7625	929.7625	1883	885.8625	930.8625
1840	884.7875	929.7875	1884	885.8875	930.8875
1841	884.8125	929.8125	1885	885.9125	930.9125
1842	884.8375	929.8375	1886	885.9375	930.9375
1843	884.8625	929.8625	1887	885.9625	930.9625
1844	884.8875	929.8875	1888	885.9875	930.9875
1845	884.9125	929.9125	1889	886.0125	931.0125
1846	884.9375	929.9375	1890	886.0375	931.0375
1847	884.9625	929.9625	1891	886.0625	931.0625
1848	884.9875	929.9875	1892	886.0875	931.0875
1849	885.0125	930.0125	1893	886.1125	931.1125
1850	885.0375	930.0375	1894	886.1375	931.1375
1851	885.0625	930.0625	1895	886.1625	931.1625
1852	885.0875	930.0875	1896	886.1875	931.1875
1853	885.1125	930.1125	1897	886.2125	931.2125
1854	885.1375	930.1375	1898	886.2375	931.2375
1855	885.1625	930.1625	1899	886.2625	931.2625
1856	885.1875	930.1875	1900	886.2875	931.2875
1857	885.2125	930.2125	1901	886.3125	931.3125
1858	885.2375	930.2375	1902	886.3375	931.3375

Table H-1 E-TACS Cellular Channel Numbers and Frequencies (Cont)

Channel Number	Mobile Transmit (MHz)	Mobile Receive (MHz)	Channel Number	Mobile Transmit (MHz)	Mobile Receive (MHz)
1903	886.3625	931.3625	1947	887.4625	932.4625
1904	886.3875	931.3875	1948	887.4875	932.4875
1905	886.4125	931.4125	1949	887.5125	932.5125
1906	886.4375	931.4375	1950	887.5375	932.5375
1907	886.4625	931.4625	1951	887.5625	932.5625
1908	886.4875	931.4875	1952	887.5875	932.5875
1909	886.5125	931.5125	1953	887.6125	932.6125
1910	886.5375	931.5375	1954	887.6375	932.6375
1911	886.5625	931.5625	1955	887.6625	932.6625
1912	886.5875	931.5875	1956	887.6875	932.6875
1913	886.6125	931.6125	1957	887.7125	932.7125
1914	886.6375	931.6375	1958	887.7375	932.7375
1915	886.6625	931.6625	1959	887.7625	932.7625
1916	886.6875	931.6875	1960	887.7875	932.7875
1917	886.7125	931.7125	1961	887.8125	932.8125
1918	886.7375	931.7375	1962	887.8375	932.8375
1919	886.7625	931.7625	1963	887.8625	932.8625
1920	886.7875	931.7875	1964	887.8875	932.8875
1921	886.8125	931.8125	1965	887.9125	932.9125
1922	886.8375	931.8375	1966	887.9375	932.9375
1923	886.8625	931.8625	1967	887.9625	932.9625
1924	886.8875	931.8875	1968	887.9875	932.9875
1925	886.9125	931.9125	1969	888.0125	933.0125
1926	886.9375	931.9375	1970	888.0375	933.0375
1927	886.9625	931.9625	1971	888.0625	933.0625
1928	886.9875	931.9875	1972	888.0875	933.0875
1929	887.0125	932.0125	1973	888.1125	933.1125
1930	887.0375	932.0375	1974	888.1975	933.1975
1931	887.0625	932.0625	1975	888.1625	933.1625
1932	887.0875	932.0875	1976	888.1975	933.1975
1933	887.1125	932.1125	1977	888.2125	933.2125
1934	887.1975	932.1975	1978	888.2375	933.2375
1935	887.1625	932.1625	1979	888.2625	933.2625
1936	887.1975	932.1975	1980	888.2875	933.2875
1937	887.2125	932.2125	1981	888.3125	933.3125
1938	887.2375	932.2375	1982	888.3375	933.3375
1939	887.2625	932.2625	1983	888.3625	933.3625
1940	887.2875	932.2875	1984	888.3875	933.3875
1941	887.3125	932.3125	1985	888.4125	933.4125
1942	887.3375	932.3375	1986	888.4375	933.4375
1943	887.3625	932.3625	1987	888.4625	933.4625
1944	887.3875	932.3875	1988	888.4875	933.4875
1945	887.4125	932.4125	1989	888.5125	933.5125
1946	887.4375	932.4375	1990	888.5375	933.5375

Table H-1 E-TACS Cellular Channel Numbers and Frequencies (Cont)

Channel Number	Mobile Transmit (MHz)	Mobile Receive (MHz)	Channel Number	Mobile Transmit (MHz)	Mobile Receive (MHz)
1991	888.5625	933.5625	2021	889.3125	934.3125
1992	888.5875	933.5875	2022	889.3375	934.3375
1993	888.6125	933.6125	2023	889.3625	934.3625
1994	888.6375	933.6375	2024	889.3875	934.3875
1995	888.6625	933.6625	2025	889.4125	934.4125
1996	888.6875	933.6875	2026	889.4375	934.4375
1997	888.7125	933.7125	2027	889.4625	934.4625
1998	888.7375	933.7375	2028	889.4875	934.4875
1999	888.7625	933.7625	2029	889.5125	934.5125
2000	888.7875	933.7875	2030	889.5375	934.5375
2001	888.8125	933.8125	2031	889.5625	934.5625
2002	888.8375	933.8375	2032	889.5875	934.5875
2003	888.8625	933.8625	2033	889.6125	934.6125
2004	888.8875	933.8875	2034	889.6375	934.6375
2005	888.9125	933.9125	2035	889.6625	934.6625
2006	888.9375	933.9375	2036	889.6875	934.6875
2007	888.9625	933.9625	2037	889.7125	934.7125
2008	888.9875	933.9875	2038	889.7375	934.7375
2009	889.0125	934.0125	2039	889.7625	934.7625
2010	889.0375	934.0375	2040	889.7875	934.7875
2011	889.0625	934.0625	2041	889.8125	934.8125
2012	889.0875	934.0875	2042	889.8375	934.8375
2013	889.1125	934.1125	2043	889.8625	934.8625
2014	889.2075	934.2075	2044	889.8875	934.8875
2015	889.1625	934.1625	2045	889.9125	934.9125
2016	889.2075	934.2075	2046	889.9375	934.9375
2017	889.2125	934.2125	2047	889.9625	934.9625
2018	889.2375	934.2375			
2019	889.2625	934.2625			
2020	889.2875	934.2875			

Table H-1 E-TACS Cellular Channel Numbers and Frequencies (Cont)

SECTION 3 - DESCRIPTION OF CONTROLS, CONNECTORS & INDICATORS

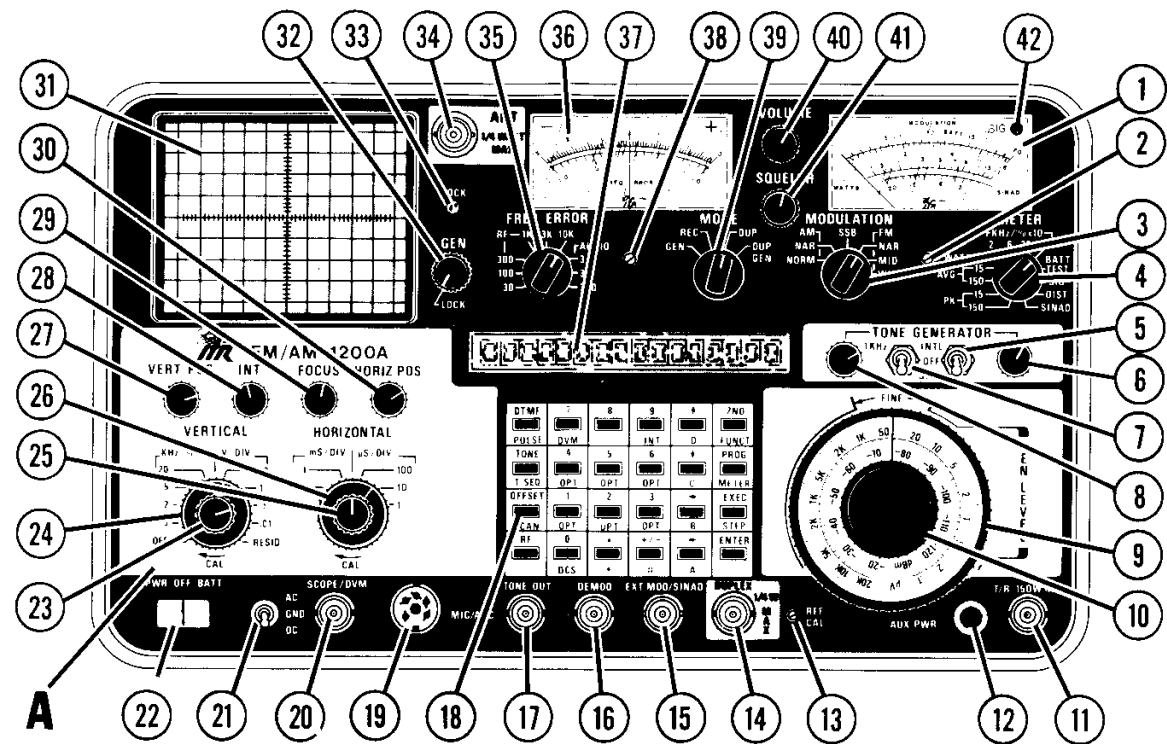

DETAIL A

FM/AM-1200S ONLY

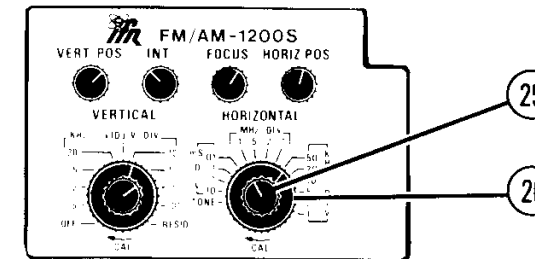

3-1 FM/AM-1200S/A FRONT PANEL (Reference Figure 3-1)

- | ITEM | NAME | DESCRIPTION |
|------|---|---|
| 1. | <u>MODULATION Meter</u> | Provides a visual display of modulation levels, RF power levels (peak and average), relative signal strength, battery test voltage, distortion and SINAD when selected by MODULATION Meter Control (4). (See Figure 3-2.) |
| 2. | <u>Modulation Meter Zero Adjustment</u> | Adjustment screw for mechanical zeroing of MODULATION Meter (1) when power to FM/AM-1200S/A is "OFF". |
| 3. | <u>MODULATION Select Control</u> | Selects modulation and demodulation modes of FM/AM-1200S/A receiver for FM, AM, SSB and their associated pre- and post-detection bandwidths as shown in Table 3-1. |

Figure 3-1 FM/AM-1200S/A Front Panel Controls, Connectors & Indicators

- | | |
|---|---|
| 1. MODULATION METER | 23. Scope VERTICAL Attenuator Vernier Control |
| 2. Modulation Meter Zero Adjustment | 24. VERTICAL Attenuator Selector Control |
| 3. MODULATION Select Control | 25. HORIZONTAL Sweep Vernier Control |
| 4. Modulation METER Control | 26. HORIZONTAL Sweep Selector Control |
| 5. VAR Tone Selector Switch | 27. VERT POS Control |
| 6. VAR Tone Level Control | 28. INT Control |
| 7. 1 kHz Tone Selector Switch | 29. FOCUS Control |
| 8. 1 kHz Tone Level Control | 30. HORIZ POS Control |
| 9. RF Level Attenuator Control | 31. CRT Display |
| 10. RF Level Attenuator Vernier Control | 32. GEN/LOCK Control |
| 11. T/R Connector | 33. LOCK Lamp |
| 12. AUX POWER Connector (Option 05 Gen. Amp only) | 34. ANT Connector |
| 13. REF CAL Adjustment | 35. FREQ ERROR Meter Range Selector Control |
| 14. DUPLEX Output Connector | 36. FREQ ERROR Meter |
| 15. EXT MOD/SINAD Connector | 37. VFD (Vacuum Fluorescent Display) |
| 16. DEMOD Connector | 38. FREQ ERROR Meter Zero Adjustment |
| 17. TONE OUT Connector | 39. MODE Selector Control |
| 18. Keyboard | 40. VOLUME Control |
| 19. MIC/ACC Connector | 41. SQUELCH Control |
| 20. SCOPE/DVM Connector | 42. SIG Indicator Lamp |
| 21. AC/GND/DC Switch (Scope) | |
| 22. PWR/OFF/BATT Switch | |

MODULATION SELECT CONTROL POSITION	DEMODULATION MODE	PRE-DETECTION BANDWIDTH	POST-DETECTION BANDWIDTH
AM			
NAR	AM	6 kHz	8 kHz
NORM	AM	15 kHz	8 kHz
SSB	SSB	6 kHz	8 kHz
FM			
NAR	FM	15 kHz	8 kHz
MID	FM	200 kHz	8 kHz
WIDE	FM	200 kHz	80 kHz

Table 3-1 Modulation Select Control Positions

- | | | |
|----|---------------------------------|---|
| 4. | <u>Modulation METER Control</u> | Selects input source for MODULATION Meter (1) as shown in Table 3-2 (Reference Figure 3-2). |
|----|---------------------------------|---|

