

IC-7300 User Evaluation & Test Report

By Adam Farson VA7OJ/AB4OJ

Iss. 2, June 3, 2016.

Figure 1: The Icom IC-7300.



Introduction: This report describes the evaluation of IC-7300 S/N 02001981 from a user perspective. **Appendix 1** presents results of an RF lab test suite performed on the radio. I was able to spend a few days with the IC-7300 in my ham-shack, and thus had the opportunity to exercise the radio's principal features and evaluate its on-air behavior.

1. Physical "feel" of the IC-7300: The IC-7300 is fairly small and light, considering that it is a full-featured 100W-class transceiver with a built-in ATU. The case dimensions are 240(W) × 238(D) × 95(H) mm and the radio weighs 4.1 kg.

The IC-7300 features a large color touch-screen display. This is an innovation in Icom's "base" HF transceiver product line, offering easy band/mode selection and navigation through the radio's menus. The placement of many control functions on the touch-screen and in the MULTI knob menus has moved many controls off the front panel.

Owners of current Icom IF-DSP transceivers should find the IC-7300 quite familiar, and should feel comfortable with it after a little familiarization with the touch-screen. In addition to the display, the front panel has a number of feature keys in location similar to those on other Icom radios as well as two concentric knobs (Twin PBT, AF Gain + RF Gain/Squelch) and MULTI to the left and right of the display respectively. Pressing the MULTI knob opens a context menu on the right edge of the screen; this menu changes with the previously-selected mode or function, allowing adjustment of appropriate parameters. The learning curve will be minimal for owners of other Icom IF-DSP radios. The Twin PBT and MULTI controls are multi-turn and detented. The main tuning knob is large and has a knurled Neoprene ring and a rotatable finger-dimple; it turns very smoothly with minimal side-play.

The standard 8-pin MIC socket, and the 3.5mm PHONES jack, is on the left side of the front panel. The supplied HM-219 hand mic or any other compatible electret or low-impedance dynamic mic can be plugged into the mic jack. (A dynamic mic requires a series blocking capacitor.) All the ports provided on other Icom radios are on the rear panel, including a USB “B” port and the 13-pin DIN ACC socket. There is no front-panel USB port. A large muffin-type cooling fan is also mounted on the rear panel.

The SD card slot for memory storage and loading, recording and firmware upgrade is below the AF/RF Gain/Squelch knob. A screen capture function (enabled via menu) allows capture of the current screen image to the SD card as a PNG or BMP file by briefly pressing the POWER key. The image can also be viewed on the screen via menu.

The IC-7300 is solidly constructed and superbly finished. Like other Icom radios, it conveys a tight, smooth, and precise overall feel. The die-cast alloy chassis also serves as a heat dissipator, and the sheet-steel case is finished in an attractive black crinkle coating. The front panel has a smooth, matte surface.

2. IC-7300 architecture: Icom is the first Japanese amateur radio manufacturer to offer an HF/6m transceiver embodying direct-sampling/digital up-conversion SDR architecture. **In the receiver**, the RF signal from the antenna feeds a high-speed ADC (analogue/digital converter) via a preselector. This is a set of bandpass filters which protect the ADC from strong out-of-band signals. The ADC digitizes a portion of the HF range defined by the preselector; the digital output of the converter feeds the Field-Programmable Gate Array (FPGA) which is configured as a digital down-converter (DDC) and delivers a digital baseband, 12 kHz wide and centered on 36 kHz, to the DSP which carries out all signal-processing functions such as selectivity, demodulation etc. A DAC (digital/analog converter) at the DSP output decodes the digital signal back to audio. Figure 2 is a simplified block diagram.

Figure 2: Simplified block diagram of IC-7300.

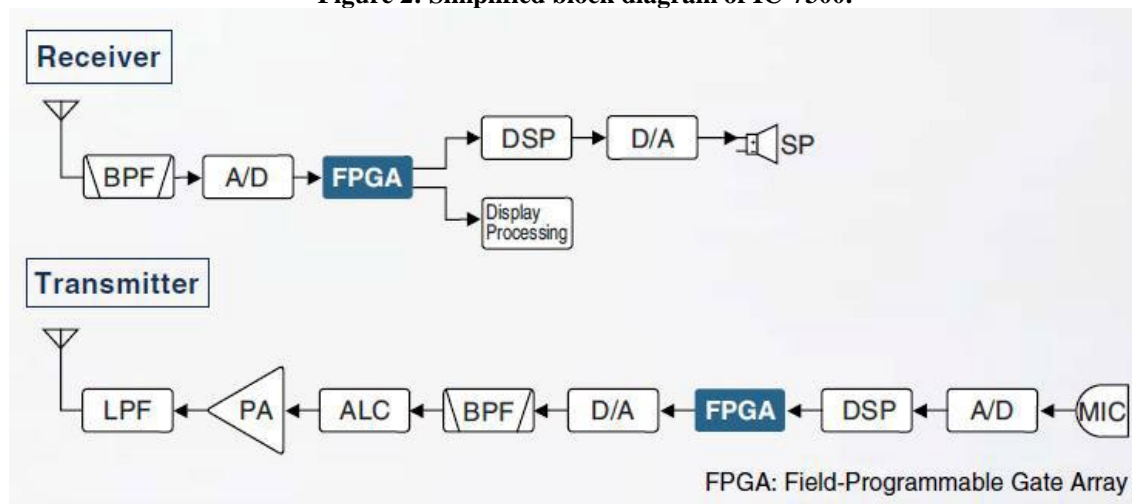

The FPGA also delivers a 1 MHz-wide digital video signal to the Display Processor, which manages the screen displays, including the fast FFT spectrum scope, waterfall, audio scope and audio FFT (spectrum analyzer) as used in other Icom transceivers (7700, 7800, 7850/7851). The spectrum scope has a maximum span of ± 500 kHz, adjustable reference level (-20 to 20 dB), video bandwidth and averaging, and minimum RBW ≤ 50 Hz.

A unique “touch-tune” feature allows quick tuning to a signal displayed on the scope by touching the scope or waterfall field to magnify an area, then touching the desired signal within that area.

In the transmitter, the audio codec converts mic audio to a digital baseband, which the DSP then processes further and the digital up-converter in the FPGA then converts to a digital RF signal at the transmit frequency. This signal is converted to analog by the high-speed DAC to the RF excitation for the PA Unit.

The IC-7300 incorporates a relay-chain type auto-tuner with a nominal 3:1 VSWR matching range. The tuner is in the signal path on receive and transmit, and can be bypassed when not required.

3. The touch-screen: The large (93 × 52 mm) color TFT **touch-screen** displays a very clear, crisp image, with excellent contrast and color saturation, and an LCD backlight. The home screen (see Figure 1) displays the current frequency in the upper field, the bar-graph meter in the middle and the spectrum scope in the lower field. The first two keys below the screen, MENU and FUNCTION, are unique to the IC-7300. The third key, M.SCOPE, moves the spectrum scope to the middle field; a different screen, selected via the MENU key, can be opened in the lower field (e.g. a multi-function meter, RTTY decoder or CW keyer controls, depending on mode). The waterfall is activated via the EXIT/SET key at the bottom right of the home screen; a reduced-height scope and waterfall can be displayed on the home screen via an EXIT/SET menu parameter.

When the Twin PBT knobs are rotated, a bandwidth/shift pop-up appears, and the trapezoidal icon at the top centre of the screen changes, a dot appears to the right of the icon. Pressing the inner PBT knob clears the Twin PBT setting. Pressing the MULTI knob opens a menu with RF PWR, MIC Gain, COMP and MONITOR settings. A setting is changed by touching its icon and rotating the MULTI knob. The MULTI knob menus are context-sensitive; for example, pressing and holding the NB key activates NB, and displays NB settings when the MULTI knob is pressed. RIT and ΔTX are adjusted by pressing their respective keys on the top right of the front panel and rotating the MULTI knob without pressing it. The CLEAR key clears these functions.

Pressing and holding the Notch, NR and NB keys makes their settings accessible from the MULTI knob. These can be used to select notch width, NR level and NB parameters respectively. When MN is selected, a pop-up displays its width.

TPF (Twin Peak Filter) can be activated via the MULTI menu in RTTY mode.

The **menus** are somewhat akin to those in other current Icom DSP radios. I found the set-up process fairly intuitive after consulting the relevant user-manual sections in cases of doubt. Icom continues the use of a “Smart Menu” system which changes available functions in a context-sensitive manner based on the mode currently in use.

Different screens are selected by pressing the MENU key on the bottom left of the screen. Menu selections with default values can be returned to default by pressing and holding their DEF softkey. Many of the screens have a “Back” arrow key to return to the previous screen.

The MENU screen includes a “SET” icon which opens a list of the 7300’s configuration settings arranged in a hierarchy which is easily navigable. The desired line in the on-screen table can be selected via the MULTI knob or up/down arrows.

The FUNCTION key opens a screen with switches for functions such as AGC, COMP, IP+, MONitor, VOX, BK-IN etc. Some of these (NB, NR, Preamp/ATT, NOTCH) duplicate front-panel keys.

The QUICK key opens a context-sensitive Quick Menu for rapid configuration or default setting of various menu functions.

Touching the leading (MHz) digits of the frequency display opens a band-selection screen; the desired band is selected by touching its designator. Mode selection is similar; touching the current mode icon opens the mode-selection screen. Tuning steps for kHz and Hz are set by touch, or by touch/hold, on the respective digit groups.

The filter selection and adjustment procedure is similar to that on other Icom DSP radios. Touch the FIL-(n) icon to toggle between FIL-1, FIL-2 and FIL-3. Touch and hold this icon to adjust the filter bandwidth and select CW/SSB Sharp/Soft shape. All IF filters are continuously adjustable. As in other Icom IF-DSP radios, filters with 500 Hz or narrower bandwidth have the BPF shape factor, but a non-BPF filter can be configured via Twin PBT.

The Time-Out Timer feature limits transmissions to a preset duration (3, 5, 10, 20 or 30 minutes, selectable by menu.) RF PWR can be turned down to 0. This feature is useful when receiving via active antennas or mast-mounted preamplifiers without T/R switching, or to avoid damaging test equipment when conducting receiver measurements.

The AUDIO screen displays an audio FFT spectrum analyzer and oscilloscope very similar to those implemented in the IC-7851, IC-7800 (Firmware V3.00 and higher) and IC-7700 (V2.00 and higher). This feature is very helpful in setting up one’s transmit audio parameters, and also for visual audio assessment of a received signal.

4. Receiver front end management: The P.AMP/ATT key toggles between Preamps 1 and 2, and an 18 dB RF attenuator. The RF Gain/Squelch control functions as an RF Gain control when rotated counter-clockwise from 12 o’clock; an on-screen RFG icon lights when RF Gain is active.

The input level limit for a direct-sampling receiver is the ADC clip level, where the digital output of the ADC is “all ones”. When the ADC clips, the receiver can no longer process signals. Thus, the 7300 provides means to prevent this condition from arising. When the ADC starts clipping, a red OVF (overflow) icon lights to the right of the filter selection icon. At this point, rotating the RF Gain control counter-clockwise will extinguish OVF and restore normal operation. RF Gain should be set just at the point where OVF goes dark, otherwise weak-signal reception will be degraded. If required, ATT can be activated as well. When OVF lights, the preamp should be turned OFF. (In general, use of the preamp on 7 MHz and below is not recommended, as the band noise is almost always higher than the receiver’s noise floor and the preamp will only boost band noise without improving signal/noise ratio.

When receiving medium-wave AM broadcast stations below 1.7 MHz, interference from strong stations can be mitigated by setting MF Band ATT to ON (Set/Function menu). This is a 16 dB attenuator, which is inserted below 1.7 MHz and is ON by default. For medium-wave AM listening on a quiet band, this feature can be turned OFF.

IP+ (Function key) activates dither and output randomization in the ADC, to improve the IMD dynamic range of the ADC. It causes some loss of sensitivity, but the receiver's noise floor will still be below the band noise in most cases. When IP+ is active, an IP+ icon lights.

Being a current IC-7700 owner, I found that the IC-7300's controls and menus fell readily to hand. A user familiar with a radio such as the IC-756Pro3 or IC-7000 should find the IC-7300 very user-friendly and its learning curve manageable. The IC-7300's default settings are very usable, allowing the radio to be placed in service with minimal initial set-up.

The IC-7300 offers a configurable SWR Plot indicator with manual stepping rather than a sweep function.

An front-panel AUTO TUNE key "tunes in" CW signals rapidly and accurately.

Touching the currently-displayed meter scale toggles between scales. Touching and holding the meter scale opens the multi-function meter, which displays all scales simultaneously.

5. USB interfaces: The IC-7300 is equipped with a rear-panel mini-USB "B" port. The radio can be directly connected via the "B" port to a laptop or other PC via the supplied USB cable. This is without doubt one of the IC-7300's strongest features. The USB port transports not only CI-V data, **but also TX and RX PCM baseband** between the IC-7300 and the computer. As a result, the USB cable is the only radio/PC connection required. Gone forever is the mess of cables, level converters and interface boxes! This feature is now standard on all Icom HF radios released since 2009. An Icom driver is required in the PC; this is downloadable from the Icom Japan World website.

6. Filter selections and Twin PBT: As do the other Icom DSP transceivers, the IC-7300 offers fully-configurable RX IF selectivity filters for all modes. Three default filter selections are available via the touch-screen for each mode, with continuously variable bandwidth via the FILTER menu. In addition, there are selectable Sharp and Soft shape factors for SSB and CW. The BPF filter configuration feature (for filter bandwidths of 500 Hz or less) operates in the same manner as on other Icom IF-DSP radios.

Twin PBT is one of the modes of the concentric multi-function controls. Pressing and holding the inner knob [CLR] restores PBT to neutral.

The TPF menu item in the RTTY SET menu selects the Twin Peak Filter (TPF) in RTTY mode. No CW APF (Audio Peak Filter) is provided. However, the CW RX LPF and HPF in the TONE SET menu are a reasonable alternative to the "missing" APF; their ranges are 100 - 2000 and 500 - 2400 Hz respectively.

The HPF and LPF can be set to "bracket" the received CW tone in a tight 100 Hz audio bandwidth. The DEF softkey restores these filters to default (off).

7. BPF vs. non-BPF filters: As in other Icom IF-DSP radios, the IC-7300 allows the user to select two additional shapes for 500 Hz or narrower filters, in addition to SHARP and SOFT. These are BPF (steeper skirts) and non-BPF (softer skirts).

To configure a BPF filter, select a 500 Hz or narrower CW, RTTY or SSB-D filter with Twin PBT neutral. To set up a non-BPF filter, select a filter with BW > 500 Hz, and narrow the filter to 500 Hz or less by rotating the Twin PBT controls. When Twin PBT is displaced from its neutral position, a dot appears to the right of the filter icon at the top of the screen.

8. Notch filters: The tunable manual notch filter (MN) is inside the AGC loop, and is extremely effective. The MN has 3 width settings (WIDE, MID and NAR); its stopband attenuation is at least 70 dB. The manual notch suppresses an interfering carrier before it can stimulate AGC action; it thus prevents swamping. To adjust the notch frequency precisely, press and hold the NOTCH key, then rotate the main tuning knob.

The auto notch filter (AN) is post-AGC. It suppresses single and multiple tones, but strong undesired signals can still cause AGC action and swamp the receiver. MN and AN are mutually exclusive, and AN is inoperative in CW mode. The NOTCH key toggles OFF – AN – MN. When MN is selected, a pop-up field is displayed on the screen, allowing selection of WIDE, MID or NAR (narrow) notch by pressing and holding the NOTCH key.

10. NR (noise reduction): The DSP NR is very effective. In SSB mode, the maximum noise reduction occurs at an NR control setting of 10. As NR level is increased, there is a slight loss of “highs” in the received audio; this is as expected. The measured SINAD increase in SSB mode was about 13 dB. For precise NR adjustment, press and hold the NR key, then rotate the MULTI knob.

11. NB (noise blanker): The IF-level DSP-based noise blanker is arguably one of the IC-7300’s strongest features. I have found it to be extremely effective in suppressing fast-rising impulsive RF events before they can stimulate AGC action within the DSP algorithm. The NB completely blanks noise impulses which would otherwise cause AGC clamping. I found its performance comparable to that of the IC-7700’s NB. The NB menu (threshold, depth and width) is accessed by pressing and holding the NB key. The NB works very effectively in conjunction with NR.

12. AGC system: The IC-7300 has an in-channel AGC loop. The digital AGC detector for the AGC loop is within the DSP algorithm. Level indications from the detector are processed in the DSP, and control the DC bias on a PIN-diode attenuator at the RF ADC input. This architecture prevents strong adjacent signals from swamping the AGC, and allows full exploitation of the ADC’s dynamic range.

The AGC menu is similar to that of other Icom IF-DSP radios. The Slow, Mid and Fast AGC settings are customizable via menu for each mode, and AGC can be turned OFF via menu.

13. Receive and transmit audio menus: The IC-7300 TONE SET menu offers the same generous selection of audio configuration parameters as that of the IC-7600 and IC-7700: TBW (low and high cutoff frequencies), RX and TX Bass/Treble EQ, RX HPF and LPF, transmit compression, etc. All audio settings are grouped under the SET/Tone Control menu.

14. Metering: The on-screen bar-graph meter displays the S-meter at all times; touching the scale toggles between P_o, SWR, ALC and COMP. Touch and hold displays the multi-function meter.

15. RTTY decoder and memory keyer: The IC-7300 features an on-screen RTTY decoder/display as well as an 8 x 70 chars RTTY memory keyer for transmitting short messages.

16. VFO/Memory management: The IC-7300 offers the same VFO and memory management features as other current Icom HF+ transceivers: VFO/memory toggle and transfer, memory write/clear, memo-pad, Split, VFO A/B swap [A/B] and equalize [touch and hold A/B], etc.

17. Brief “on-air” report: Upon completing the test suite, I installed the IC-7300 in my shack and connected it to my 1 kW amplifier and multi-band HF/6m vertical antenna

a) SSB: I spent several hours chatting on 40m SSB with friends who are familiar with my voice and the sound of my signal. Distant stations reported that the audio quality of my transmissions was "excellent" when using the Heil PR-781 desk mic plugged into the radio's MIC socket via an OPC-589 adapter cable. Two stations I worked on 40m SSB assisted me in optimizing transmit audio settings for the PR-781 and supplied HM-219. I tested the IC-7300 with two other mics; the supplied HM-219 and a British Army NATO dynamic mic. I noted that the PR-781 required higher Mic Gain and COMP settings than either the HM-219 or the NATO mic. The reported audio quality with the HM-219 was very good, with some popping on plosive sounds. The NATO mic yielded a bright and highly articulate sound, if somewhat lacking in lows. (No surprise there!)

The following are the transmit audio settings I used in the SSB trials:

Table 1: Transmit audio settings.

Mic	Band	Conditions	Mic Gain	TBW	COMP	Bass	Treble
PR-781	40m	S9+	85%	WIDE 100-2900	8	+1	+5
HM-219	40m	S9+	50%	WIDE 200-2900	5	0	+3
NATO	40m	S9+	20%	WIDE 100-2900	5	+1	+1

As discussed in **11.** above, the DSP-based noise blanker is superb. It does not distort the signal at all, and can be left on at all times; it is every bit as good as the IC-7700 or IC-7600 blanker. At my QTH, with Level 5, Depth 8 and Width 80, the NB suppressed fast-rising noise spikes and almost completely eliminated locally-generated electrical noise from HV power lines and industrial processes.

As discussed in Section 10 above, I found the NR very effective on SSB. Even at 10, NR did not attenuate “highs” excessively. NR is very effective in conjunction with NB.

Preamp 1 (7 dB gain) brought weak stations up to very comfortable copy without S/N degradation. The SSB filters and Twin PBT were excellent, as we have come to expect from other Icom DSP radios. MN and AN were extremely helpful. I was able to notch out single tones with MN; also, AN reduced the levels of multiple tones. I did not use Preamp 2 on 40m, as it is optimized for 50 MHz and higher.

The superior phase-noise performance of a direct-sampling SDR (as compared to a conventional superhet) and the absence of passive IMD due to crystal filters in the signal path really showed in the 7300's clean reception in the presence of strong adjacent-channel interference during my on-air SSB tests.

Overall, I found that band noise on SSB at my QTH was sufficiently obtrusive to require the use of NR (Level 10) at all times. Still, SSB operation on 20m with a mix of strong and weak signals was quite comfortable and pleasant. Receive audio quality was crisp and smooth. Subjectively, I was impressed by the clarity of received signals.

b) CW: I made a brief CW QSO on 40m using a straight key.. With 500 and 250 Hz CW filters (Sharp, BPF) and NR/NB on, ringing was minimal with Preamp off. I then set up a 250 Hz filter (Soft, non-BPF) with NR on and Preamp off. Again, there was virtually no audible ringing, and the received CW note was very smooth. Activating Preamp 1 or 2 raised the noise level slightly, but did not cause significant ringing.

In a brief test of full-break-in operation at 20-23 wpm, I found this mode quite smooth, with fast receiver recovery. On keying transitions, a slight “thump” was audible in the headphones.

c) AM: In a quick check of AM reception, I listened to various MF and HF broadcast stations. A local station on 690 kHz and a music broadcast on 5995 kHz sounded good on the IC-7300's internal speaker, but much clearer (as one would expect) on my external speaker or on the headset. I did note that the AM IF filters cut off quite steeply below 200 Hz.

The 9 kHz AM filter offered the best frequency response, but the 6 kHz setting sounded somewhat “smoother” and 3 kHz cut the “highs” excessively. The IC-7300's Twin PBT is fully functional in this mode. Mid AGC was best for average to good signal conditions, but Fast AGC handled rapid selective fading more effectively. NR was quite effective in improving the S/N ratio of weak AM signals.

The NR did not distort the recovered audio. NR Level 6 was the “sweet spot”, providing optimum noise reduction with minimal attenuation of highs. Higher NR settings cut the highs excessively. Above 10, the NR control had no further effect. (Note that the AM bass and treble EQ settings were both 0 dB, with HPF off.)

AN was effective in suppressing interfering tones and heterodynes, but MN caused some distortion when tuned across the signal. The reason for this is that MN suppresses the carrier in a manner similar to selective fading.

Slight hiss was evident when receiving weak AM signals, but NR largely suppressed it.

d) RTTY: I tuned in some 40m RTTY signals and was able to tune them accurately with the FFT tuning aid and decode them reliably using the internal decoder.

18. ACC/USB AF Output Level Check: During receiver testing, I checked the receive AF levels at the USB port using a spectrum-analysis program, and at ACC Pin 12 using a true RMS voltmeter. All levels were well within specifications. The 32% level setting (SET/Connectors menu) yielded lowest THD at the USB port.

18a. ACC MOD and USB MOD Input Level Check: During transmitter testing, I also checked the AF input levels at the USB port using a tone-generator program, and at ACC Pin 11 using an audio signal generator, for 100W PEP output. All levels were well within specifications. To use the USB port, I installed the Ver. 1.2 Icom USB drivers (downloadable from the Icom Japan world-wide support site).

<http://www.icom.co.jp/world/support/download/firm/>

19. Case temperature: The radio showed no signs of excessive heating even after 2 hours' "rag-chew" SSB operation at 100W PEP output. Average case temperature was 33°C, rising to 35°C at the hottest point after several minutes' key-down transmit at 100W during transmitter testing (temperature indicator blue).

20. Concerns: Three items warranting further analysis were encountered during the tests: excess background noise and MDS degradation with IP+ on, several receiver "birdies" (mainly in the 0.5 – 3.6 MHz range) and transmitted IMD performance on 50 MHz. These will be discussed in more detail in the relevant sections of this report.

21. Conclusion: After a few days' "cockpit time" on the IC-7300, I am very favorably impressed by its solid, refined construction, clear and informative display, easy familiarization experience, smooth operating "feel", impressive array of features and excellent on-air performance. This radio is unique in that it is a true, stand-alone* direct-sampling/digital up-conversion SDR in an attractive, compact package. Yet again, Icom has a winner with the SDR performance, intuitive touch-screen and the straightforward USB computer interface. This is certainly a lot of radio for its price category.

22. Acknowledgements: I would like to thank Ray Novak N9JA at Icom America, and Paul Veel VE7PVL and Jim Backeland VE7JMB at Icom Canada for making an IC-7300 available to me for testing and evaluation.

**Stand-alone SDR: self-contained, not requiring a computer as a prerequisite for operation.*

Adam Farson, VA7OJ/AB4OJ April 11, 2016
e-mail: farson@shaw.ca <http://www.ab4oj.com/>.

Update history:

Iss.1: Pre-release, April 15, 2016.

Iss.2: IFSS and spectrum scope sensitivity tests added. June 3, 2016.

Copyright © 2016 A. Farson VA7OJ/AB4OJ. All rights reserved.

Appendix 1: Performance Tests on IC-7300 S/N 02001981

As performed in my home RF lab, April 1-12, 2016. Firmware V1.11 (except where noted).

A. HF/6m Receiver Tests

I: MDS (Minimum Discernible Signal) is a measure of ultimate receiver sensitivity. In this test, MDS is defined as the RF input power which yields a 3 dB increase in the receiver noise floor, as measured at the audio output.

Test Conditions: SSB 2.4 kHz & CW 500 Hz SHARP, ATT off, NR off, NB off, Notch off. AGC-M. Max. RF Gain. Levels in dBm. IP+ off except where shown.

Table 2: MDS (HF, 6m).

MHz	1.905		3.605		14.1		28.1		50.1		70.1	
Preamp	SSB	CW	SSB	CW	SSB	CW	SSB	CW	SSB	CW	SSB	CW
Off	-125	-131	-124	-132	-127	-134	-122	-129	-124	-131	-124	-131
IP+	-113	-121	-114	-121	-114	-122	-110	-118	-116	-123	-113	-121
ATT					-114							
1	-133	-141	-133	-141	-135	-142	-131	-139	-134	-141	-133	-140
2	-134	-142	-134	-142	-136	-143	-133	-141	-135	-142	-133	-141

Note on IP+ and MDS: With IP+ on, 10 – 13 dB MDS degradation was observed. In addition, the AF background noise level rises by ≈ 10 dB. This effect increases on bands below 7 MHz, and can readily be seen in Figure 3.

It is understood that IP+ activates ADC dither and randomization. On other direct-sampling SDR receivers previously tested, little or no increase in noise floor was observed with dither and randomization on.

It is recommended that this phenomenon receive further analysis.

Figure 3: Audio noise output with IP+ off and on. ANT input terminated in 50Ω.

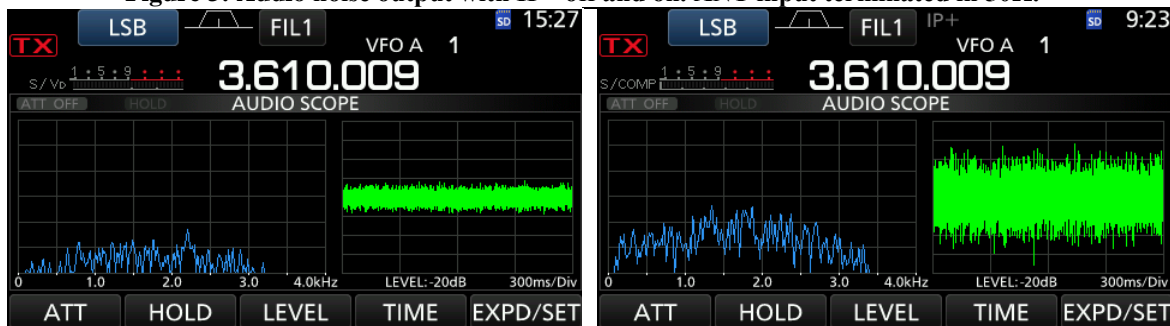

Ia: ADC Clip Levels. In this test, the receiver is offset +25 kHz above the test signal frequency and the input level required to light the on-screen **OVF** icon is noted.

OVF indication occurs only when a strong out-of-channel signal is present. In-channel signals stimulate AGC action which attenuates the signal at the ADC input.

Test Conditions: RX tuned to 14.1 MHz, test signal freq. 14.125 MHz, CW 500 Hz SHARP, ATT off, NR off, NB off, Notch off. AGC-M. Max.RF Gain.

Table 3: OVF (Clip) Levels.

Preamp	OVF (Clip) Level dBm
Off	-10
IP+	-10
1	-23
2	-27

Ib: AM Sensitivity. Here, an AM test signal with 30% modulation at 1 kHz is applied to the RF input. The RF input power which yields 10 dB (S+N)/N is recorded (Table 4). At 0.9 MHz, readings are taken with the 16 dB MF Band Attenuator off and on. (This attenuator is valid only for $f \leq 1.7$ MHz).

Test Conditions: ATT off, NR off, NB off, Notch off. AGC-M. Wide (9 kHz) AM filter. (-Levels in dBm.

Table 4: AM Sensitivity.

Preamp	MF Band ATT	0.9 MHz	3.9 MHz	14.1 MHz
Off	OFF	-105	-107	-109
	ON	-89		
1		-112	-113	-114
2		-113	-115	-115

Notes:

1. Very clean demodulation; full quieting ≈ -75 dBm (preamp off).
2. NR suppresses high-frequency hiss at low signal levels. Unmodulated carrier at -115 dBm (preamp off, NR off) increases noise floor by 4 dB.

Ic. 12 dB SINAD FM sensitivity: In this test, a distortion meter is connected to the PHONES jack, and an FM signal modulated by a 1 kHz tone with 3 kHz peak deviation is applied to the RF input. Input signal power for 12 dB SINAD is recorded (Table 4).

Table 5: FM 12 dB SINAD Sensitivity in dBm.

Preamp	29.5 MHz	52.525 MHz	70.5 MHz
Off	-109	-109	-109
1	-120	-119	-121
2	-122	-121	-122

In this test, a test signal from a high-quality 5 MHz OCXO with known low phase noise is injected into the receiver's RF input at a fixed offset from the operating frequency. The RF input power is increased until the receiver noise floor increases by 3 dB, as measured at the audio output. Reciprocal mixing noise, expressed as a figure of merit, is the difference between this RF input power and measured MDS. The test is run with preamp off. The higher the value, the better.

Test Conditions: CW mode, 500 Hz filter, preamp off, ATT off, NR off, AGC-M, NB off, max. RF Gain, positive offset. Reciprocal mixing *in dB* = input power – MDS (both *in dBm*). Phase noise *in dBc/Hz* = -(RMDR+10 log 500) = -(RMDR + 27). **Note:** For $\Delta f > 20$ kHz, OVF lights before noise floor increases by 3 dB.

Table 6: Reciprocal Mixing Noise in dB (HF/6m).

Δf kHz	RMDR dB	Phase noise dBc/Hz
1	100	-127
2	109	-136
5	115	-142
10	117	-144
20	119	-146

3: IF filter shape factor (-6/-60 dB). This is the ratio of the -60 dB bandwidth to the -6 dB bandwidth, which is a figure of merit for the filter’s adjacent-channel’s rejection. The lower the shape factor, the “tighter” the filter.

In this test, an approximate method is used. An RF test signal is applied at a power level approx. 60 dB above the level where the S-meter just drops from S1 to S0. The bandwidths at -6 and -60 dB relative to the input power are determined by tuning the signal generator across the passband and observing the S-meter.

Test Conditions: 14.100 MHz, SSB/CW modes, preamp off, IP+ off, AGC-M, ATT off, NR off, NB off.

Table 7: IF Filter Shape Factors.

Filter	Shape Factor		6 dB BW kHz	
	Sharp	Soft	Sharp	Soft
2.4 kHz SSB	1.37	1.45	2.48	2.36
1.8 kHz SSB	1.59	1.53	1.81	1.93
500 Hz CW	1.64	1.60	0.52	0.55
250 Hz CW	1.51	2.45	0.25	0.25

4: AGC threshold. An RF test signal is applied at a level 6 dB below AGC threshold, with AGC off. The signal is offset 1 kHz from the receive frequency to produce a test tone. The AF output level is observed on an RMS voltmeter connected to the PHONES jack.

Test Conditions: 14.100 MHz, 2.4 kHz USB, Preamp off, IP+ off, AGC M, ATT off, NR off, NB off. Initial RF input level -105 dBm.

With AGC-M, increase RF input power until AF output level increases < 1 dB for a 1 dB increase in input level. Measured values per **Table 8**.

Table 8: AGC Threshold.

Preamp	AGC Threshold dBm
Off	-99
1	-106
2	-109
IP+	-100

5: Manual Notch Filter (MNF) stopband attenuation and bandwidth. In this test, an RF signal is applied at a level ≈ 70 dB above MDS. The test signal is offset 1 kHz from the receive frequency to produce a test tone. The MNF is carefully tuned to null out the tone completely at the receiver audio output. The test signal level is adjusted to raise the baseband level 3 dB above noise floor. The stopband attenuation is equal to the difference between test signal power and MDS.

Test Conditions: 14.100 MHz USB at ≈ -50 dBm (S9 + 20 dB), 2.4 kHz Sharp, AGC-M, preamp off, IP+ off, ATT off, NR off, NB off, MNF on, Twin PBT neutral.

Test Results: Measured MDS was -127 dBm per Test 1. Stopband attenuation = test signal power - MDS.

Table 9: Manual Notch Filter Attenuation.

MNF BW	Test Signal dBm	Stopband Atten. dB
WIDE	-47	80
MID	-51	76
NAR	-57	70

5a. Auto-Notch (AN) Check: AN completely suppresses AF tone at -7 dBm input level. The receive frequency is now offset on either side of the null by pressing RIT and rotating the MULTI knob. The frequencies at which the audio output rises by 6 dB are noted. The **-6 dB bandwidth** is the difference between these two frequencies.

Table 10: MNF BW.

MNF -6 dB BW Hz	
Wide	129
Mid	92
NAR	59

6: AGC impulse response. The purpose of this test is to determine the IC-7300's AGC response in the presence of fast-rising impulsive RF events. Pulse trains with short rise times are applied to the receiver input.

Test Conditions: 3.6 MHz LSB, 2.4 kHz SSB filter (Sharp), NR off, NB off/on, Preamp off/1, AGC-F, with decay time set to 0.1 sec.

Figure 4: Audio scope display for AGC impulse response test.

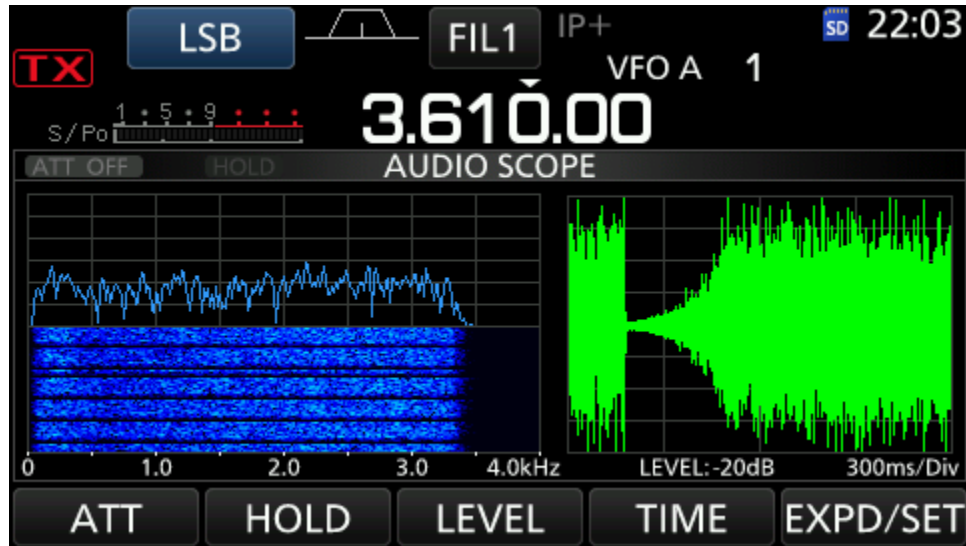

Test with pulse trains. Here, the pulse generator is connected to the IC-7300 RF input via a step attenuator. The IC-7300 is tuned to 3.6 MHz, as the RF spectral distribution of the test pulse train has a strong peak in that band. AGC Fast (0.1 sec) and Preamp 2 are selected.

The pulse rise time (to 70% of peak amplitude) is 10 ns. Pulse duration is varied from 12.5 to 100 ns. In all cases, pulse period is 600 ms. The step attenuator is set at 23 dB. Pulse amplitude is $16V_{pk}$ (e.m.f.)

The AGC recovers completely within the 0.1 sec window; there is no evidence of clamping. NR softens the tick sound.

Table 11: AGC impulse response.

Pulse duration ns	Tick	AGC recovery ms	S: Pre off	S: Pre 1
12.5	Y	≈ 100 (no clamping)	S9	S9
30	Y	≈ 100 (no clamping)	S9	S9
50	Y	≈ 100 (no clamping)	S9	S9
100	Y	≈ 100 (no clamping)	S9	S9

7: Noise blanker (NB) impulse response. As the IC-7300's noise blanker is a DSP process "upstream" of the AGC derivation point, the NB should be very effective in suppressing impulsive RF events before they can stimulate the AGC. To verify this, the NB is turned on during Test 6 (above).

Test Conditions: NB on, Preamp 1 or 2, Level 509, Depth 4 or 5, Width 68.

At all pulse durations, the S-meter deflection and "ticks" are *completely suppressed* (with Preamp off, 1 and 2) showing that the impulsive events never reach the AGC derivation point. With Preamp off, there are no ticks at 12.5 ns, but faint ticks are heard at 30 ns. Occasional faint artifacts are heard, but on-air signals and/or band noise would mask these completely.

Next, NR is activated. With NR at 9 to 10, any residual artifacts are suppressed.

- As in other Icom IF-DSP radios, the NB mitigates AGC response to fast-rising RF events.

9: S-meter tracking & AGC threshold. This is a quick check of S-meter signal level tracking.

Test Conditions: 2.4 kHz USB, Preamp off, ATT off, AGC MID. A 14.100 MHz test signal at MDS is applied to the RF input. The signal power is increased, and the level corresponding to each S-meter reading is noted. (S9 readings are taken with Preamp off, Preamp 1 and Preamp 2 in turn.)

Table 12a: S-Meter Tracking.

S	S1	S2	S3	S4	S5	S6	S7	S8	S9	S9+10	S9+20	S9+30	S9+40	S9+50	S9+60
dBm	-97	-94	-92	-89	-86	-83	-80	-76	-73	-63	-54	-45	-36	-26	-17
S9 = -80 dBm (Preamp 1), -84 dBm (Preamp 2)															

9a: Attenuator tracking. This is a quick verification of attenuator accuracy.

Table 12b: ATT Value.

ATT	Atten. dB
OFF	0
ON	20

11a. Two-Tone 3rd-Order Dynamic Range (DR₃). The purpose of this test is to determine the range of signals which the receiver can tolerate while essentially generating no spurious responses.

In this test, two signals of equal amplitude P_i and separated by a 2 kHz offset Δf are injected into the receiver input. If the test signal frequencies are f_1 and f_2 , the offset $\Delta f = f_2 - f_1$ and the 3rd-order intermodulation products appear at $(2f_2 - f_1)$ and $(2f_1 - f_2)$.

The two test signals are combined in a passive hybrid combiner and applied to the receiver input via a step attenuator. The receiver is tuned to the upper and lower 3rd-order IMD products ($2f_2 - f_1$ and $2f_1 - f_2$ respectively) which appear as a 600 Hz tone in the speaker. The per-signal input power level P_i is adjusted to raise the noise floor by 3 dB, i.e. IMD products at MDS. The P_i values for the upper and lower products are recorded and averaged. $DR_3 = P_i - MDS$.

DR3 is measured with IP+ off and on, to determine the effect of internal dither and randomization on front-end linearity.

Note: IP_3 (3rd-order intercept) is not included here, as this parameter is irrelevant to a direct-sampling SDR. The transfer and IMD curves of the ADC diverge, so the intercept point does not exist.

Test Conditions: $f_1 = 14.010$ MHz, $f_2 = 14.012$ MHz, 500 Hz CW, AGC-S, ATT off, NR off, NB off, CW Pitch = 12 o'clock.

Table 13: 20m DR₃.

Preamp	IP+ off	IP+ on
Off	77	90
1	79	93
2	76	96

11b. Two-Tone 2nd-Order Dynamic Range (DR₂) & Second-Order Intercept (IP₂). The purpose of this test is to determine the range of signals far removed from an amateur band which the receiver can tolerate while essentially generating no spurious responses within the amateur band.

In this test, two widely-separated signals of equal amplitude P_i are injected into the receiver input. If the signal frequencies are f_1 and f_2 , the 2nd-order intermodulation product appears at $(f_1 + f_2)$. The test signals are chosen such that $(f_1 + f_2)$ falls within an amateur band.

The two test signals are combined in a passive hybrid combiner and applied to the receiver input via a step attenuator. The receiver is tuned to the IMD product $(f_1 + f_2)$ which appears as a 600 Hz tone in the speaker. The per-signal input power level P_i is adjusted to raise the noise floor by 3 dB, i.e. IMD product at MDS. The P_i value is then recorded.

$DR_2 = P_i - MDS$. Calculated $IP_2 = (2 * DR_2) + MDS$.

Test Conditions: $f_1 = 6.1$ MHz, $f_2 = 8.1$ MHz, CW mode, 500 Hz filter, AGC off, ATT off, NR off, NB off, CW Pitch = 12 o'clock. DR₂ in dB; IP₂ in dBm.

Table 14: 6.1/8.1 MHz DR₂.

IP+	MDS dBm, 14.2 MHz	DR ₂ dB	IP ₂ dBm
off	-134	108	+82
on	-122	95	+68

11c. Two-Tone IMD_3 (IFSS, Interference-Free Signal Strength) tested in CW mode (500 Hz), ATT = 0 dB, AGC Med. Test frequencies: $f_1 = 14010$ kHz, $f_2 = 14012$ kHz. IMD_3 products: 14008/14014 kHz. IMD_3 product level was measured as absolute power in a 500 Hz detection bandwidth at various test-signal power levels with IP+ (Dither/Random) off, on and on with Preamp 1. AGC off, ATT= 0 dB. The ITU-R P-372.1 band noise levels for typical urban and rural environments are shown as datum lines. The input level at the top end of each curve corresponds to -1 dBFS, or 1 dB below OVF (ADC clip) level. See Figure 5.

The IMD product level was derived by measuring the S/N ratio of the IMD product for each input level setting, and subtracting MDS.

Figure 5: IFSS (2-tone IMD_3) vs. test signal level.

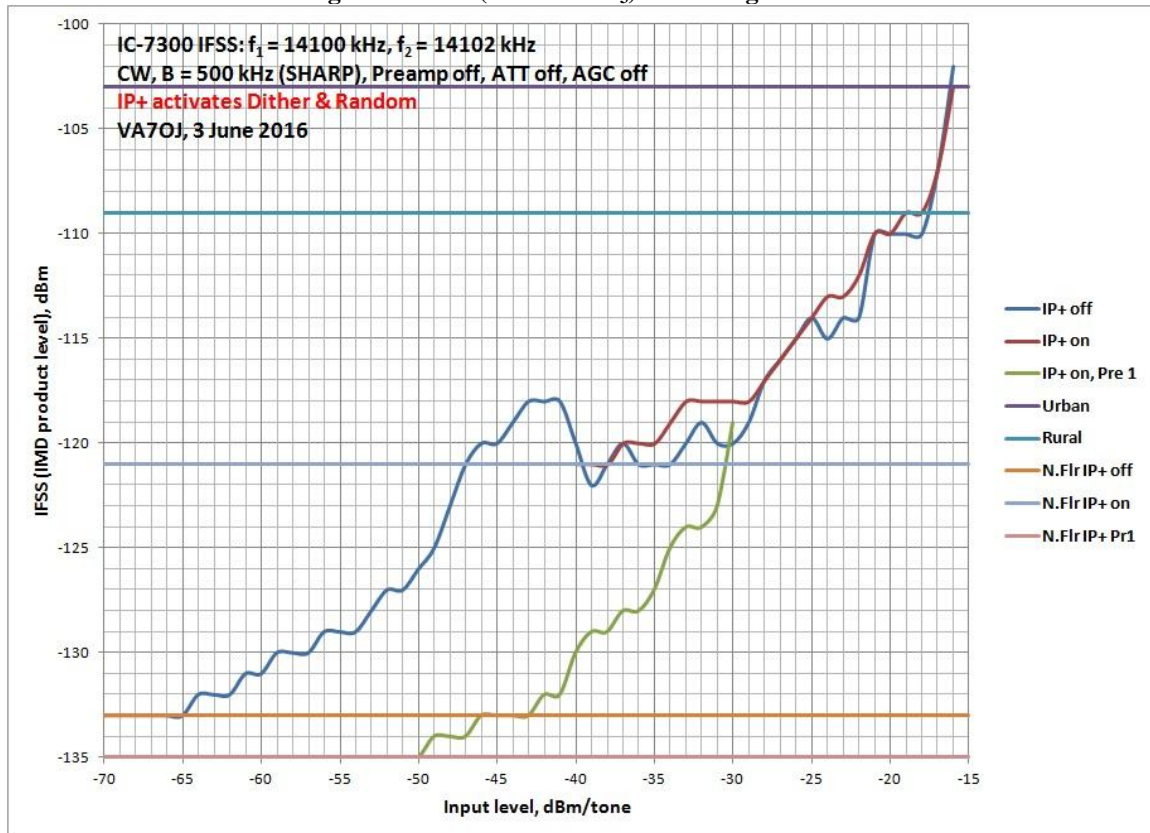

Notes on 2-tone IMD_3 test: This is a new data presentation format in which the amplitude relationship of the actual IMD_3 products to typical band-noise levels is shown, rather than the more traditional DR_3 (3rd-order IMD dynamic range) or SFDR (spurious-free dynamic range). The reason for this is that for an ADC, SFDR referred to input power rises with increasing input level, reaching a well-defined peak (“sweet spot”) and then falling off. In a conventional receiver, SFDR falls with increasing input power.

If the IMD_3 products fall below the band-noise level at the operating site, they will generally not interfere with desired signals.

The IC-7300 IFSS data is presented here as an adjunct to the traditional DR_3 test data. See **Reference 1**.

12a. Spectrum Scope Resolution Bandwidth. In a spectrum analyzer, the resolution bandwidth (RBW) determines how far apart in frequency two (or more) signals must be to be resolved into separate and distinct displays on the screen.

Test conditions: Test signals: $f_1 = 10100$ kHz, $f_2 = 10100.100$ kHz, CW, 250 Hz. Span = ± 2.5 kHz, VBW = Narrow, Averaging = 4, ATT OFF, REF LEVEL = +20 dB, preamp off. Waterfall on, speed MID (default).

To measure RBW, f_1 and f_2 are injected into the antenna input at a level sufficient to produce spikes whose vertical amplitude reaches the top of the scope grid. f_2 is moved closer to f_1 until two distinct spikes are *just* observable. To facilitate adjustment, the signal spike image can be touched to open the zoom window.

Test result: Two signals can be clearly distinguished at 50 Hz spacing, i.e. 50 Hz minimum RBW.

Figure 6a: Spectrum scope RBW (50 Hz).

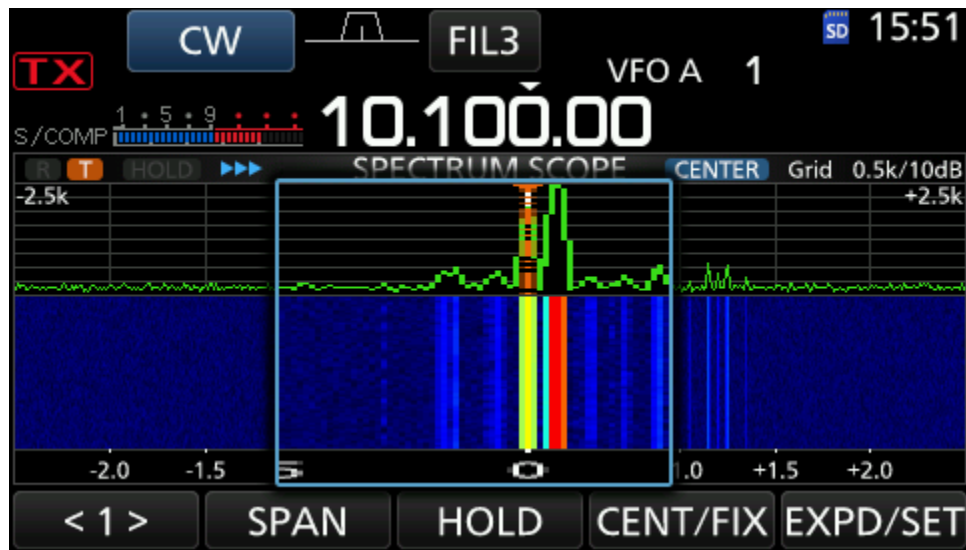

12b. Spectrum Scope Sensitivity: In this test, the RF input signal level is adjusted to produce a spike which is just visible above the scope "grass" level.

Test conditions: 14.100 MHz Span = ± 2.5 kHz, VBW = Wide, Averaging = 4, ATT OFF, REF LEVEL = +20 dB, Waterfall off. DSP filter setting is irrelevant.

Table 15: Spectrum Scope Sensitivity.

Minimum Visible Spike for Span = ± 2.5 kHz	
Preamp	Level dBm
Off	-111
1	-126
2	-131

Figure 6b. Spectrum scope sensitivity.



Notes on spectrum scope: Two refinements to the spectrum scope would enhance its usefulness as a BITE (built-in test equipment) feature:

- An option to display a vertically expanded scope field without the waterfall when EXPD/SET is pressed, The Audio Scope field can be expanded vertically in this manner.
- Extended scope dynamic range, to display signal amplitude from the noise floor to ADC clip level. This would greatly facilitate use of the scope as a signal-analysis tool.

13. Noise Power Ratio (NPR): An NPR test was performed, using the test methodology described in detail in *Ref. 1*. The noise-loading source used for this test was a noise generator fitted with bandstop (BSF) and band-limiting filters (BLF) for the test frequencies utilized.

$$\text{NPR} = P_{\text{TOT}} - \text{BWR} - \text{MDS}$$

where P_{TOT} = total noise power in dBm for 3 dB increase in audio output

BWR = bandwidth ratio = $10 \log_{10} (B_{\text{RF}}/B_{\text{IF}})$

B_{RF} = RF bandwidth or noise bandwidth in kHz (noise source band-limiting filter)

B_{IF} = receiver IF filter bandwidth in kHz

MDS = minimum discernible signal (specified at B_{IF}), measured at 2.4 kHz SSB prior to NPR testing

Test Conditions: Receiver tuned to bandstop filter center freq. $f_0 \pm 1.5$ kHz, 2.4 kHz SSB, ATT off, max. RF Gain, Preamp off, IP+ off, NR off, NB off, Notch off, AGC-S. Test results are presented in Table 16.

Table 16: NPR Test Results.

DUT	BSF kHz	BLF kHz	Preamp	IP+	MDS dBm	P_{TOT} dBm	BWR dB	NPR dB
IC-7300	1940	60...2044	0	0	-125	-20	29.2	76
	3886	60...4100	0	0	-124	-15.3	32.3	76
	5340	60...5600	0	0	-126	-14	33.6	78
	7600	316...8160	0	0	-123	-15.4	35.1	74

Note on NPR test: When testing NPR on other direct-sampling receivers, I have found that the noise loading drove the ADC into clipping before the AF noise output increased by 3 dB. Thus, I developed an alternative method in which the noise loading is set to 1 dB below clipping and the NPR read directly off the spectrum scope. As discussed in *Test II* above, the limited amplitude range of the IC-7300 spectrum scope precludes that method, but on the IC-7300 it was possible to obtain a 3 dB increase in AF noise output without ADC clipping. This allowed use of the “legacy” test method as described in *Ref. 2*.

Even so, it was not possible to test NPR with the preamp or IP+ on, as clipping occurred with these settings. Nonetheless, I was able to obtain meaningful NPR values, which can be compared with those for other radios.

14. Aliasing rejection: 74.800 MHz is the top of the IC-7300 tuning range. In this test, a test signal at 79.800 MHz is to the antenna port and the IC-7300 is tuned to its alias frequency (69.800 MHz). The test signal power is increased sufficiently to raise the AF output by 3 dB.

Test Conditions: Receive frequency 69.800 MHz, CW, 500 Hz. Test signal at 79.800 MHz applied to ANT input. ATT off, max. RF Gain, Preamp off, IP+ off, NR off, NB off, Notch off, AGC-S. RMS voltmeter connected to PHONES jack.

Test signal level = -40 dBm for 3 dB AF level increase. MDS = -131 dBm.

Aliasing rejection = $-40 - (-131) = 91$ dB.

15. Receiver latency: Latency is the transit time of a signal across the receiver, i.e. the time interval between arrival of the signal at the antenna input and appearance of the demodulated signal at the AF output. Various aspects of receiver design exert a major influence on latency; among these are DSP speed and group delay across selectivity filters. As the DSP speed is fixed by design, we measure latency for various filter configurations (bandwidth and shape factor). Figure 6 illustrates an example.

To measure latency, repetitive pulses are fed to the DUT antenna input and also to Channel 1 of a dual-trace oscilloscope. Channel 2 is connected to the DUT AF output. The scope is triggered from the pulse generator's trigger output. The time interval between the pulses displayed on Channels 1 and 2 is recorded for each test case.

Figure 7: RX latency, 250 Hz SOFT CW filter. 2 ms/div.



Test Conditions: 3.6 MHz, Preamp off, AGC Fast, IP+ off, max. RF Gain, ATT off, NR off, NB off.

Table 17: Receive latency test results.

Mode	Filter BW kHz	Shape Factor	Latency ms
LSB	3.6	Soft/Sharp	3.7
	2.4		3.2
	1.8		3.7
CW	1.2	Soft/Sharp	4.1
	0.5	Soft/Sharp	8.0
	0.25	Sharp	17.0
	0.25	Soft	14.0
RTTY	2.4		3.5
	0.5		9.0
	0.25		≈ 16

16. NR noise reduction, measured as SINAD: This test is intended to measure noise reduction on SSB signals close to the noise level. A distortion meter is connected to the PHONES jack. The test signal is offset 1 kHz from the receive frequency to produce a test tone, and RF input power is adjusted for a 6 dB SINAD reading. NR is then turned on, and SINAD read at 30%, 50% and 60% (max.) NR settings.

Test conditions: 14.1 MHz USB, 2.4 kHz Sharp, AGC-M, preamp off, IP+ off, max. RF Gain, ATT off, NB off, Twin PBT neutral. Test signal at -122 dBm (6 dB SINAD)

Table 18: Noise reduction vs. NR setting.

NR Setting	0	1	2	3	4	5	6	7	8	9	10	11
SINAD dB	6	7	8	9	10	12	14	16	18	19 (MAX.)		

This shows an S/N improvement of 13 dB with NR at maximum for an SSB signal \approx 2 dB above MDS. This is an approximate measurement, as the amount of noise reduction is dependent on the original signal-to-noise ratio.

16. Audio THD: In this test, an audio distortion analyzer is connected to the external speaker output. An 8 Ω resistive load is connected across the analyzer input. An S7 to S9 RF test signal is applied to the antenna input, and the main tuning is offset by 1 kHz to produce a test tone. The audio voltage corresponding to 10% THD is then measured, and the audio output power calculated.

Test Conditions: 14.100 MHz, 3 kHz USB, AGC-F, ATT off, NR off, NB off, Preamp off. Offset tuning by -1 kHz.

Test Result: Measured audio output voltage = 4.00V rms.

Thus, audio power output = $\sqrt{[(4)^2/8]} = \mathbf{2.0W}$ in 8 Ω at 1 kHz. (Spec. is 2W).

17. Spurious signals (“birdies”): The following spurious signals were observed with the ANT input terminated in 50 Ω :

Table 19: Spurious signals in receiver.

Freq. kHz	Band	Mode	Signal Type	S-meter rdg.	Remarks
79		USB	Tone	S6	Steady
539	MWBC	CW	Tone	S0	
600		USB	Warble	S0	
669		CW	Tone	S0	
800		USB	Noise-band	S2-3	30 kHz wide
1035		CW	Tone	S0	Weak
1200		USB	Warble	S0	Weak
1619		USB	Noise-band	S0-1	\approx 10kHz wide
1800		160m	USB	Warble	S0
3240		CW	Tone	S0	Weak
3600	80m	USB	Warble	S0-1	Weak
9144		USB	Tone	S0	
14469		USB	Tone	S0	
62016		USB	Tone	S0	

B. Transmitter Tests

18: CW Power Output. In this test, the RF power output into a 50Ω load is measured at 3.6, 14.1, 28.1 and 50.1 MHz in RTTY mode, at a primary DC supply voltage of +13.8V. A thermocouple-type power meter is connected to the IC-7300 RF output via a 50 dB power attenuator.

Table 20: CW Power Output.

Freq. MHz	3.61	14.1	28.1	50.1
P _O W	101.3	100.5	101.7	100.5
% RF PWR	88	89	91	91
I _{DC} at 100W A	15.7	16.6	16.2	17.5
Max. P _O W	117.8	115.6	113.6	112.1

RX/Standby: I_{DC} = 0.9A.

Emergency Tune (typical): 3.61 MHz, P_O = 56.6W, I_{DC} = 12.5A.

QRP (5W nominal): 3.61 MHz, P_O = 5W. I_{DC} = 5.7A.

19: SWR Graph. The SWR Graph feature was tested with 50Ω and 75Ω resistive loads connected in turn to ANT1. The RF POWER setting remained unchanged when switching loads.

Test Conditions: 28.350 MHz RTTY. P_o = 10W into 50Ω and 75Ω loads. Sweep range: 28.050 – 28.650 MHz.

Flat SWR readings of 1.0:1 and 1.4:1 were obtained across the entire sweep with the 50Ω and 75Ω loads respectively. See Figure 8.

Figure 8: SWR Graph test with nominal 75Ω load.



20: SSB Peak Envelope Power (PEP). Here, an oscilloscope is terminated in 50Ω and connected to the IC-7300 RF output via a 50 dB high-power attenuator. At 100W CW, the scope vertical gain is adjusted for a peak-to-peak vertical deflection of 6 divisions.

Test Conditions: USB mode, HM-219 mic connected, RF PWR 91%, Mic Gain 50%, COMP OFF/ON, TBW = WIDE, COMP at 5 (≈ 6 dB compression on voice peaks), SSB TX Bass/Treble set at 0 dB (default), supply voltage +13.8V.

Speak loudly into the microphone for full-scale ALC reading. Figures 8 & 9 show the envelope for 100W PEP, without and with compression respectively. ± 3 vertical divisions = 100W.

Figure 9: 100W PEP speech envelope, no compression.

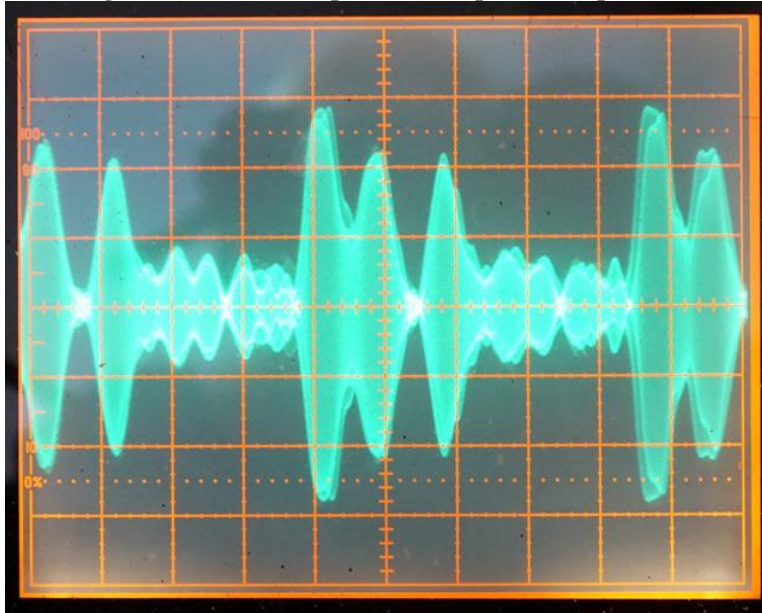
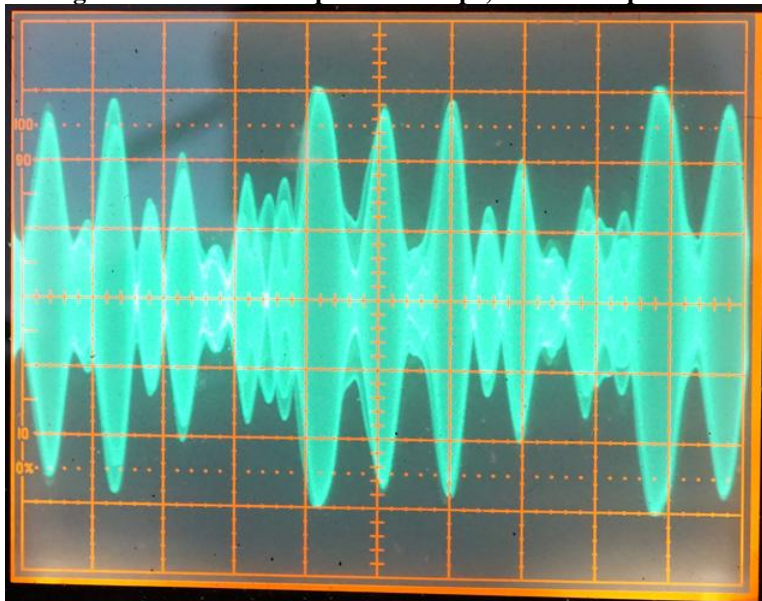

Figure 10: 100W PEP speech envelope, ≈ 6 dB compression.



Note that no ALC overshoot was observed in either test case.

21: SSB ALC overshoot: A test was conducted in which white noise was applied via the USB port, and the RF envelope observed on an oscilloscope terminated in 50Ω and connected to the IC-7300 RF output via a 50 dB high-power attenuator.

Test Conditions: 14100 kHz USB, COMP off, DATA OFF MOD = USB, USB MOD Level = 50% (default). Test signal: white noise. WIDE TBW (default value) selected. Supply voltage +13.8V.

Set $P_o = 100W$ in RTTY mode. Select USB, then adjust USB Audio Codec device volume on computer for 50% ALC reading.

Test Result: No ALC overshoot was observed.

Note: The overshoot test was re-run on 5 – 6 November 2016 under Firmware V1.14, with $P_o = 20W$. **Result:** No ALC overshoot was observed.

Figure 11: 100W white noise test (± 3 vert. div. = 100W PEP).

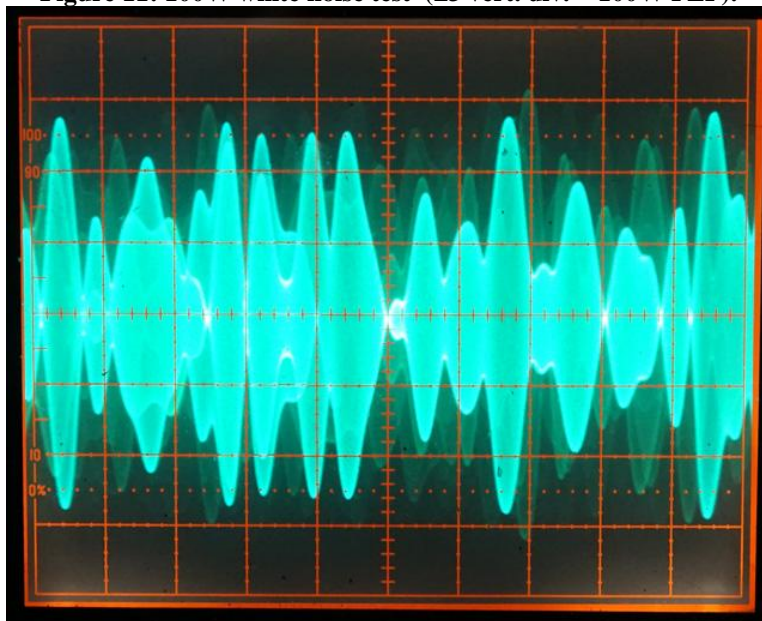

22. ALC Compression Check. In this test, a 2-tone test signal is applied to the USB port from a tone-generator program running on a laptop computer. An oscilloscope is connected to the IC-7300 RF output via a 50 dB high-power attenuator. RF Power is initially adjusted for 100W output in RTTY mode.

Test Conditions: 14100 kHz USB, COMP off, DATA OFF MOD = USB, USB MOD Level = 50% (default). Test tones: 700 and 1700 Hz, at equal amplitudes. WIDE TBW (default value) selected. Supply voltage +13.8V.

Test Result: No flat-topping of the 2-tone envelope was observed (see Figure 11.)

Figure 12: 2-tone envelope, 100W PEP.

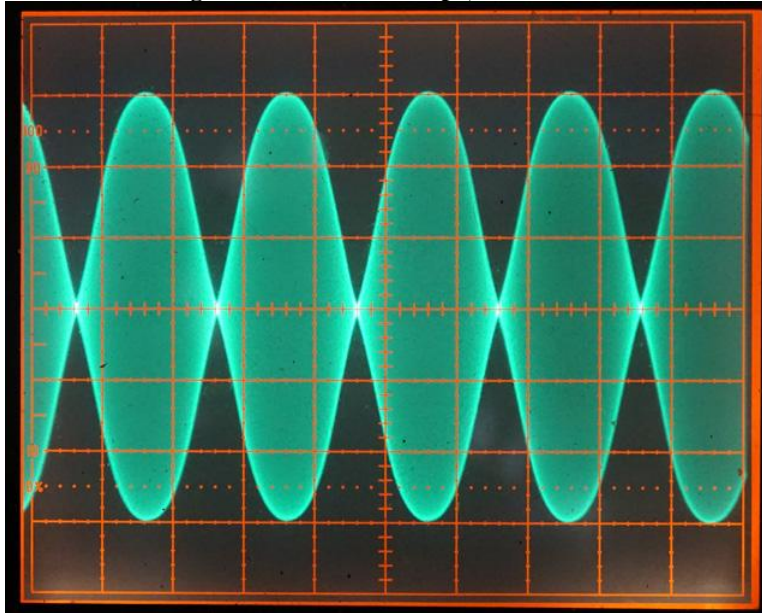

23: Transmitter 2-tone IMD Test. In this test, a 2-tone test signal is applied to the USB port from a tone-generator program running on a laptop computer. A spectrum analyzer is connected to the IC-7300 RF output via a 60 dB high-power attenuator. RF Power is initially adjusted for rated CW output on each band in turn.

Test Conditions: DC supply 13.8V, measured at DC power socket. 3.6, 14.1, 50.1, 144.1 and 432.1 MHz USB, DATA OFF MOD = USB, USB MOD Level = 50% (default). Test tones: 700 and 1700 Hz, at equal amplitudes. The -10 dBm reference level RL equates to rated CW output (= 0 dBc).

On computer, adjust USB Audio Codec device volume for 100W PEP (each tone at -6 dBc). Figures 12 through 15 show the two test tones and the associated IMD products for each test case.

Table 21. 2-tone TX IMD.

2-tone TX IMD Products at Rated P _o				
IMD Products	Rel. Level dBc (0 dBc = 1 tone)			
Freq. MHz	3.6	14.1	28.1	50.1
IMD3 (3 rd -order)	-40	-39	-33	-25
IMD5 (5 th -order)	-35	-34	-33	-30
IMD7 (7 th -order)	-44	-43	-44	-34
IMD9 (9 th -order)	-57	-56	-54	-46
Add -6 dB for IMD referred to 2-tone PEP				

Note on 6m IMD3: On 6m, the measured IMD is worse than on the other bands tested, but still meets the -25 dBc guideline stated in ITU-R Recommendation SM.327-7.

23a. Noise IMD Test. This test is similar to Test 23, except that a white-noise baseband is applied to the USB port from the tone-generator program. Spectrograms are captured at 100W and 25W PEP, as shown in Figure 17. Note that the IMD skirts are steeper at the lower power level.

Figure 13: Spectral display of 2-tone IMD at 3.6 MHz, 100W PEP.

IC - 7300 80m 100W PEP TX IMD 060416

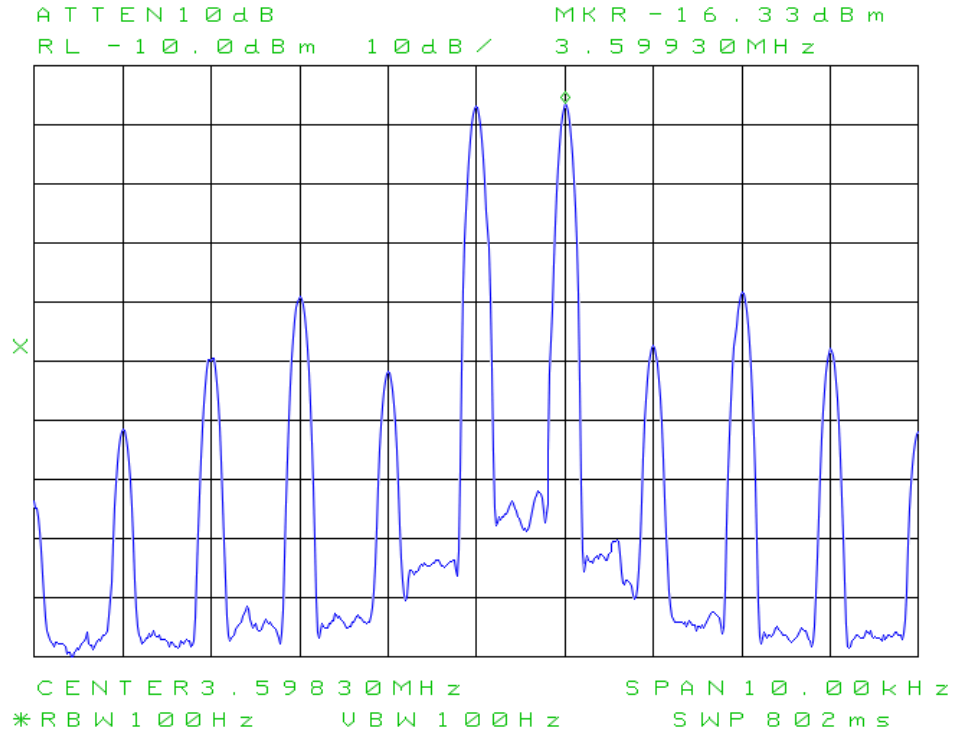

Figure 14: Spectral display of 2-tone IMD at 14.1 MHz, 100W PEP.

IC - 7300 20m 100W PEP TX IMD 060416

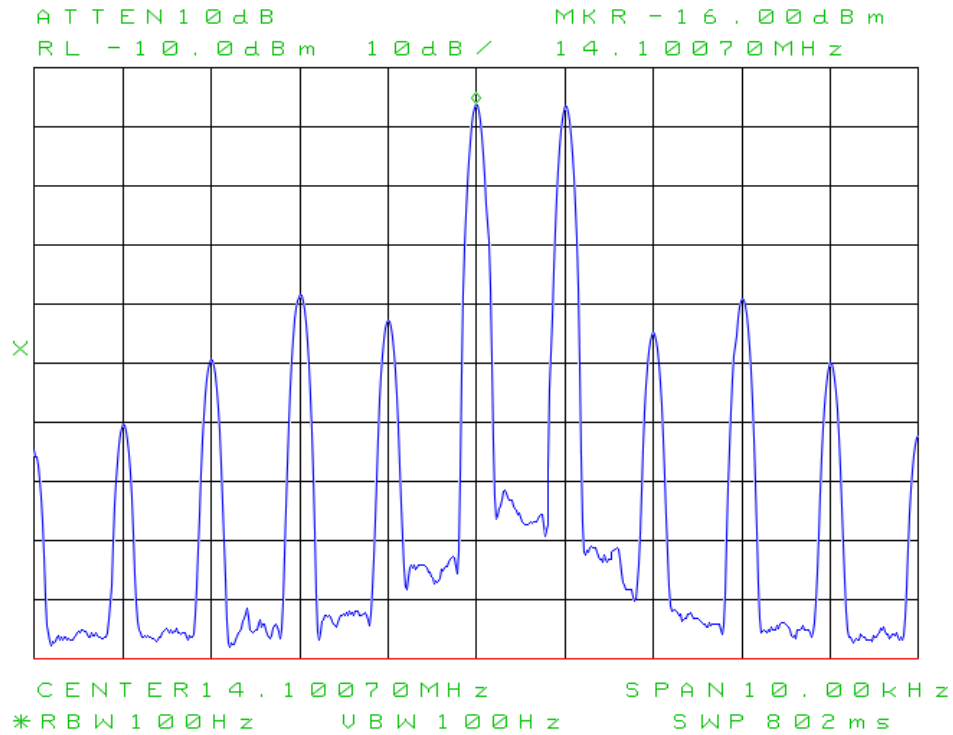

Figure 15: Spectral display of 2-tone IMD at 28.1 MHz, 100W PEP.

IC - 7300 10m 100W PEP TX IMD 060416

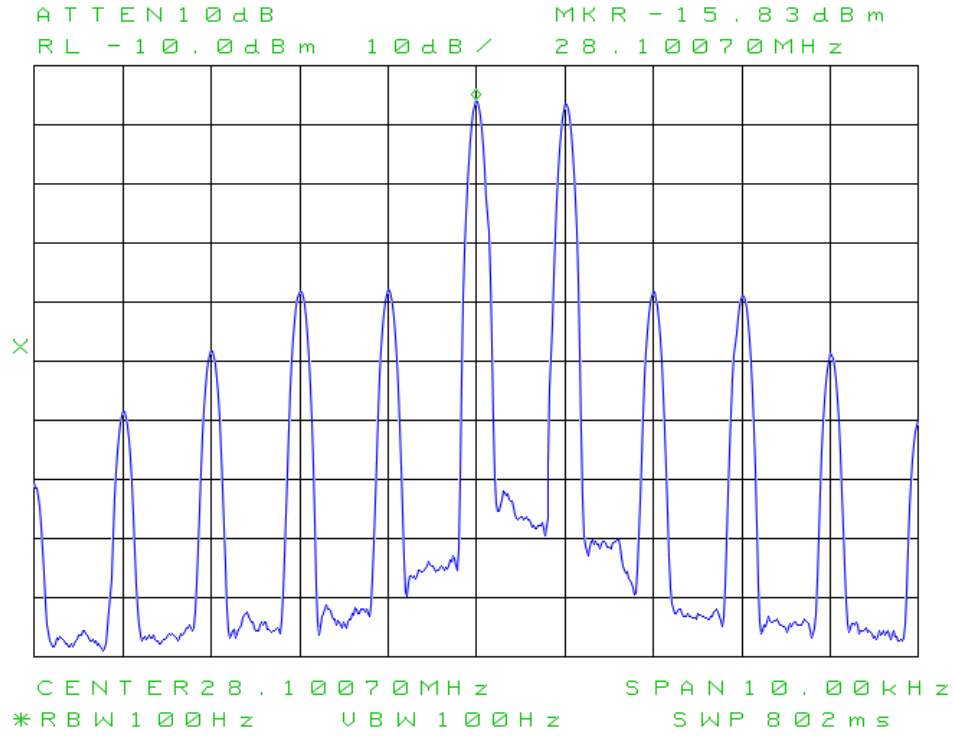

Figure 16: Spectral display of 2-tone IMD at 50.1 MHz, 100W PEP.

IC - 7300 6m 100W PEP TX IMD 060416

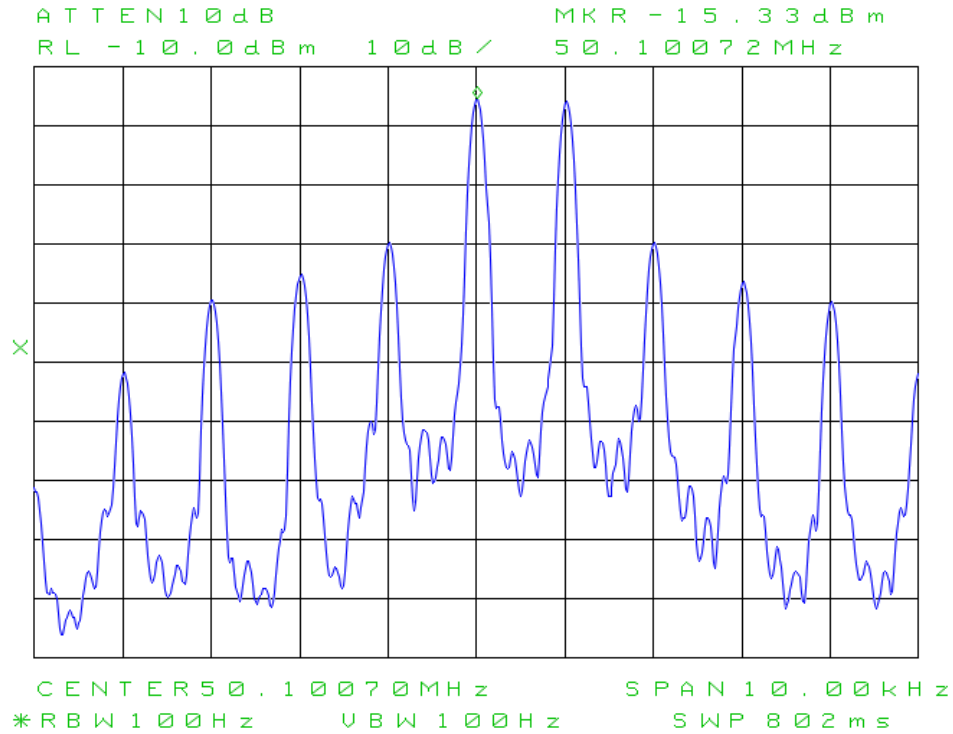
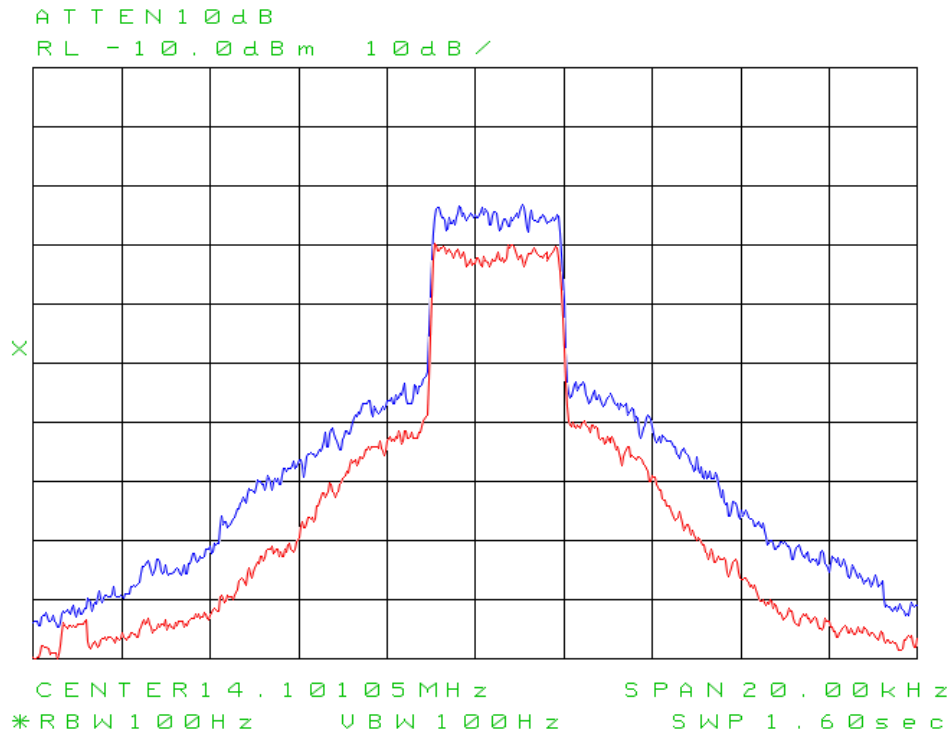

Figure 17: 20m noise modulation, showing IMD skirts.

IC-7300 20m NOISE IMD B: 100W R: 25W 060416



24: AM sidebands and THD with single-tone modulation. As in Test 23 above, the spectrum analyzer is connected to the IC-7300 RF output via a 50 dB high-power attenuator. On the IC-7300, RF Power is adjusted for 25W resting carrier. A 1 kHz test tone is applied to the USB port from the tone-generator program running on the laptop computer. The spectrum analyzer records the carrier and sideband parameters.

Test Conditions: 14100 kHz AM, 25W carrier output, DATA OFF MOD = USB, USB MOD Level = 50% (default).

On computer, adjust USB Codec device volume for -6 dBc test tone level (100% modulation.) Figure 17 shows the carrier and sideband levels. Calculated THD \approx 2%.

Figure 18: AM Sidebands for 100% Modulation.

IC - 7 3 0 0 2 0 m A M S i d e b a n d s 2 5 W C X R 0 6 0 4 1 6

D I S C R E T E S I D E B A N D S E A R C H R E S U L T S

CARRIERFREQ: 14.10 MHz
CARRIERPOWER: -15.7 dBm

OFFSET FREQ	- OFFSET	+ OFFSET
	dBc	dBc
.998 kHz	-5.7	-6.0
1.997 kHz	-35.8	-35.8
2.996 kHz	-32.5	-32.3
4.004 kHz	-68.8	-65.0
5.003 kHz	-55.0	-54.5

FOUND: 5 SETS OF SIDEBANDS
100% Modulation

24a: AM TX spectrum with white-noise modulation. As in Tests 23 and 24 above, the spectrum analyzer is connected to the IC-7300 RF output via a 50 dB high-power attenuator. On the IC-7300, RF Power is adjusted for 12.5W resting carrier. White noise is applied to the USB port from the tone-generator program running on the laptop computer. A spectrogram is captured at 12.5W carrier (50W PEP), as shown in Figure 19.

Test Conditions: Firmware V1.14. 14100 kHz AM, 12.5W carrier output, DATA OFF MOD = USB, USB MOD Level = 50% (default). USB Audio Codec device volume: As for Test 24 (100% modulation)..

Figure 19.

IC-7300 A3E WHNOISE 12.5W CXR M=1.0 080517

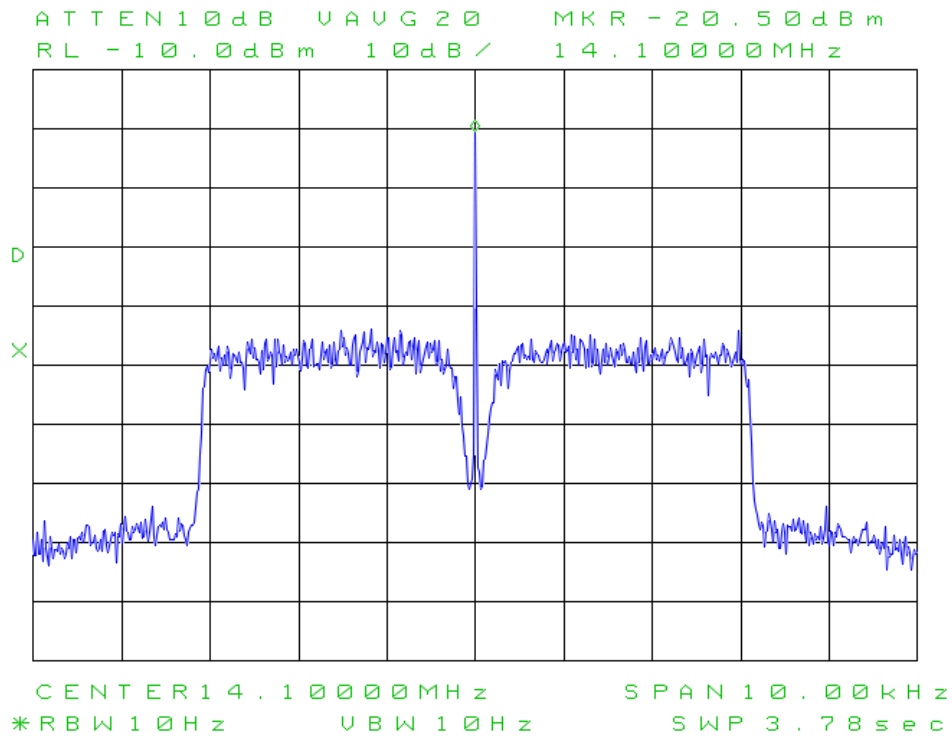

25: Transmitter harmonics & spectral purity. Once again, the spectrum analyzer is connected to the IC-7300 RF output via a 60 dB high-power attenuator. RF Power is adjusted for rated CW output on each band in turn. The 0 dBm reference level equates to 100W. The spectrum analyzer's harmonic capture utility is started.

Test Conditions: 3.6, 14.1, 28.1, 50.1 MHz, RTTY, rated output to 50Ω load. Utility start and stop frequencies are configured as shown in Figures 20 through 27 inclusive. Harmonic data and spur sweeps are presented for HF/6m. It will be seen that harmonics and spurs are well within specifications.

Figure 21.

IC-7300 20m Harmonics 100W 060416

HARMONIC MEASUREMENT RESULTS
 FUNDAMENTAL SIGNAL: 14.10 MHz
 -9.8 dBm

HARMONIC	LEVEL dBc	FREQUENCY
2	-79.5	28.20 MHz
3	-60.0	42.30 MHz
4	-78.8	56.40 MHz
5	-74.5	70.50 MHz
6	-78.2	84.60 MHz
7	-82.7	98.70 MHz
8	-85.7	112.8 MHz

TOTAL HARMONIC DISTORTION: .1 %
 (OF HARMONICS MEASURED)

Figure 22.

IC-7300 20m Spurs/Harmonics 100W CW 060416

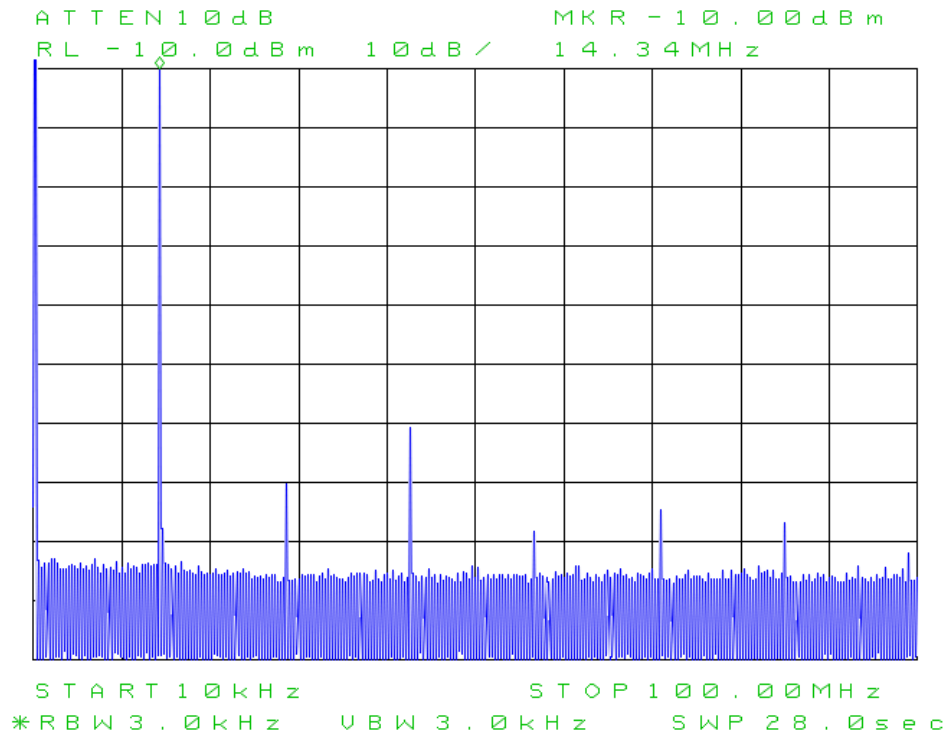

Figure 23.

IC-7300 10m Harmonics 100W 060416

HARMONIC MEASUREMENT RESULTS

FUNDAMENTAL SIGNAL: 28.10 MHz
-10.0 dBm

HARMONIC	LEVEL dBc	FREQUENCY
2	-60.8	56.20 MHz
3	-87.2 *	84.30 MHz
4	-78.7	112.4 MHz
5	-65.7	140.5 MHz
6	-100.3 *	168.6 MHz
7	-102.8 *	196.7 MHz
8	-104.7 *	224.8 MHz

* MEASURED LEVEL MAY BE NOISE OR LOST SIGNAL.

TOTAL HARMONIC DISTORTION: .1 %
(OF HARMONICS MEASURED)

Figure 24.

IC-7300 10m Spurs / Harmonics 100W CW 060416

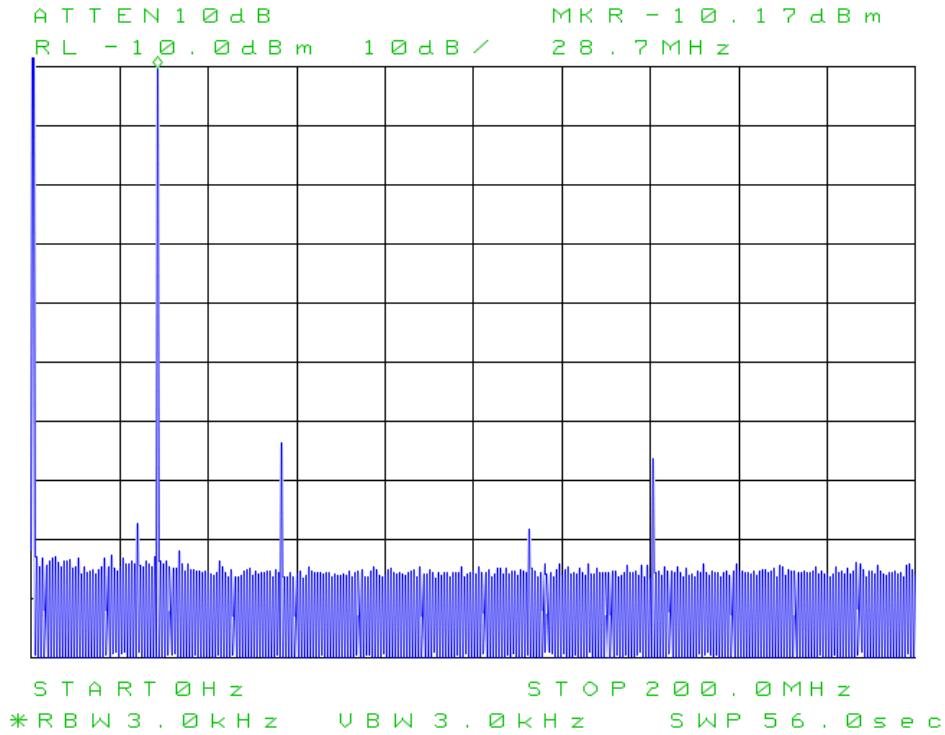

Figure 25.

HARMONIC MEASUREMENT RESULTS

FUNDAMENTAL SIGNAL: 50.10 MHz
-9.8 dBm

HARMONIC	LEVEL dBc	FREQUENCY
2	-78.3 *	100.2 MHz
3	-85.2	150.3 MHz
4	-87.5	200.4 MHz
5	-83.0	250.5 MHz
6	-105.5 *	300.6 MHz
7	-106.2 *	350.7 MHz
8	-106.5 *	400.8 MHz

* MEASURED LEVEL MAY BE NOISE OR LOST SIGNAL.

TOTAL HARMONIC DISTORTION: 0 %
(OF HARMONICS MEASURED)

Figure 26.

IC-7300 6m Spurs/Harmonics 100W CW 060416

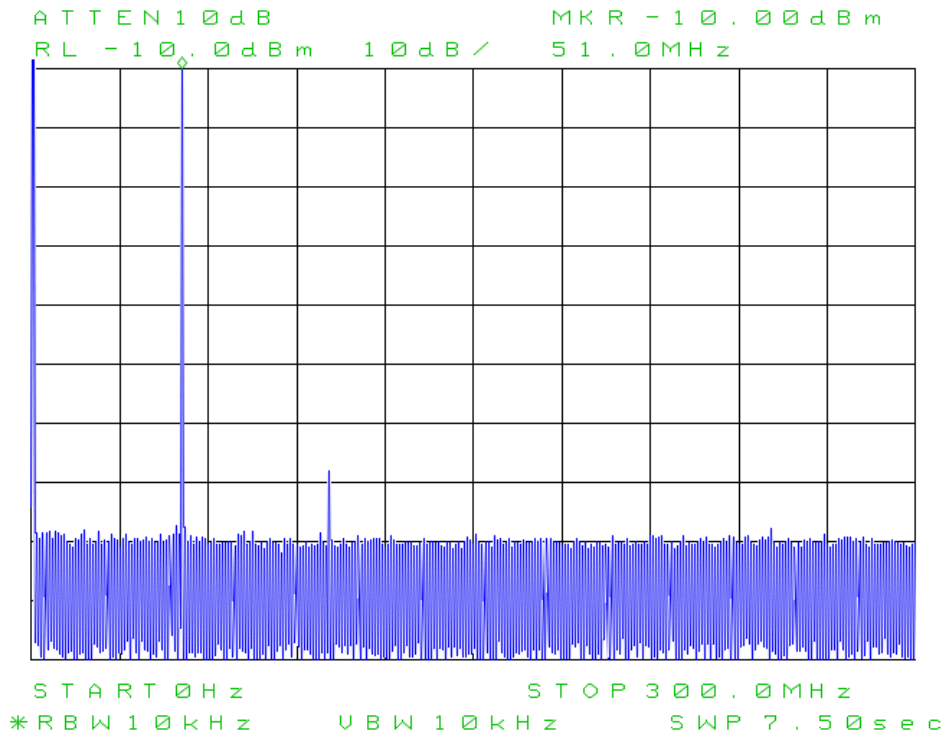

26: Transmitted composite noise. A Perseus SDR receiver is connected to the IC-7300 RF output via a 50 dB high-power attenuator feeding a 0-90 dB step attenuator. The step attenuator is set to -1 dBFS (1 dB below ADC clipping) on the Perseus at zero offset. Next, the noise level is read off the Perseus signal-strength indicator at 1-2-5 offsets in the range 0.1 to 100 kHz. Figure 28 is the resulting composite-noise chart.

Test Conditions: 3.6, 14.1, 28.1 and 50.1 MHz RTTY, 100W to 50Ω load. Perseus settings: preselector off, preamp off, dither off, channel bandwidth 50 Hz, RBW 30.5 Hz. (**Note:** The Perseus noise floor is approx. -151 dBc/Hz. An uncertainty of ± 1 to 2 dB may occur at input levels close to this noise floor.)

Figure 27: Transmitted composite noise.

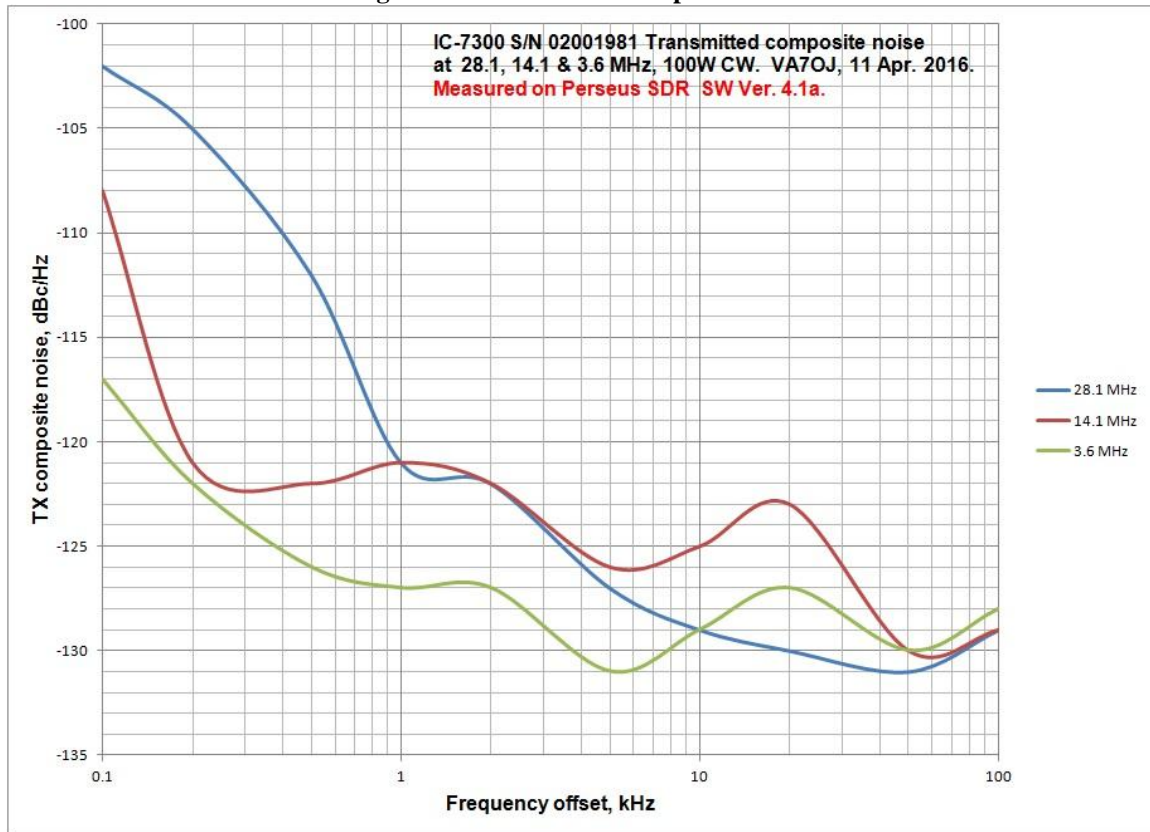

27: Spectral display of CW keying sidebands. The spectrum analyzer is connected to the IC-7300 RF output via a 60 dB high-power attenuator. The -10 dBm reference level equates to 100W. A series of dits is transmitted at the highest keying speed.

Test Conditions: 14.1 MHz CW, 100W output to 50Ω load. Keying speed 48 wpm (KEY SPEED max.) using internal keyer. Spectrum analyzer RBW is 10 Hz, video-averaged; sweep time < 4 sec. Figures 29 and 30 show the transmitter output ±5 kHz from the carrier at 2/4 and 6/8 ms rise-time, respectively..

Figure 28: Keying sidebands at 48 wpm, 2/4 ms rise-time 14.1 MHz, 100W.

I C 7 3 0 0 C W s i d e b a n d s B 2 m s R 4 m s 4 8 w p m 0 7 0 4 1 6

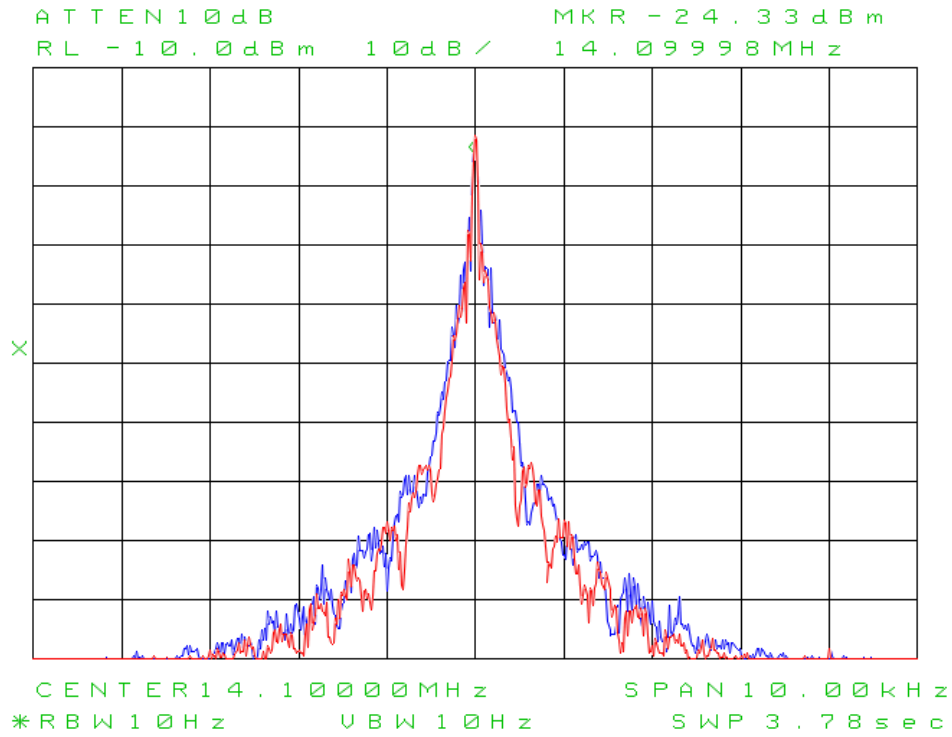
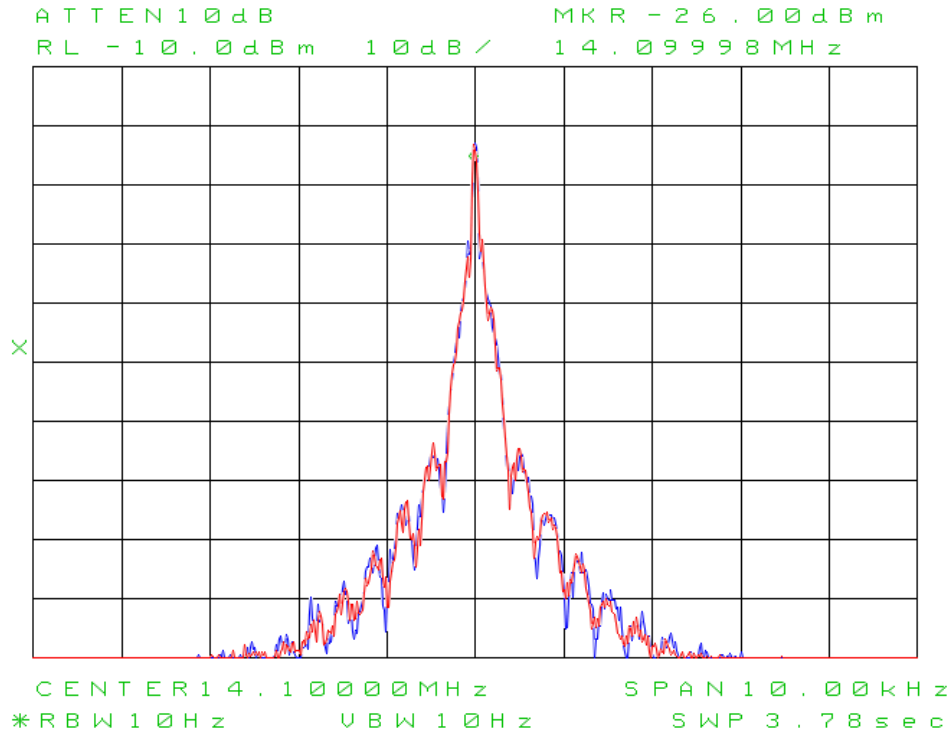

Figure 29: Keying sidebands at 48 wpm, 6/8 ms rise-time 14.1 MHz, 100W.

I C 7 3 0 0 C W s i d e b a n d s B 6 m s R 8 m s 4 8 w p m 0 7 0 4 1 6



27a. CW keying envelope: The oscilloscope is terminated in 50Ω and connected to the IC-7300 RF output via a 50 dB high-power attenuator. A series of dits is transmitted from the internal keyer at the highest keying speed (48 wpm) in semi-break-in mode (BK).

Test Conditions: 14.1MHz CW, 100W output to 50Ω load. CW rise time = 4 ms (default), TX DELAY (HF & 50M) OFF.

Figure 30: Keying envelope at 48 wpm, 2 ms rise time, 2 ms/div.

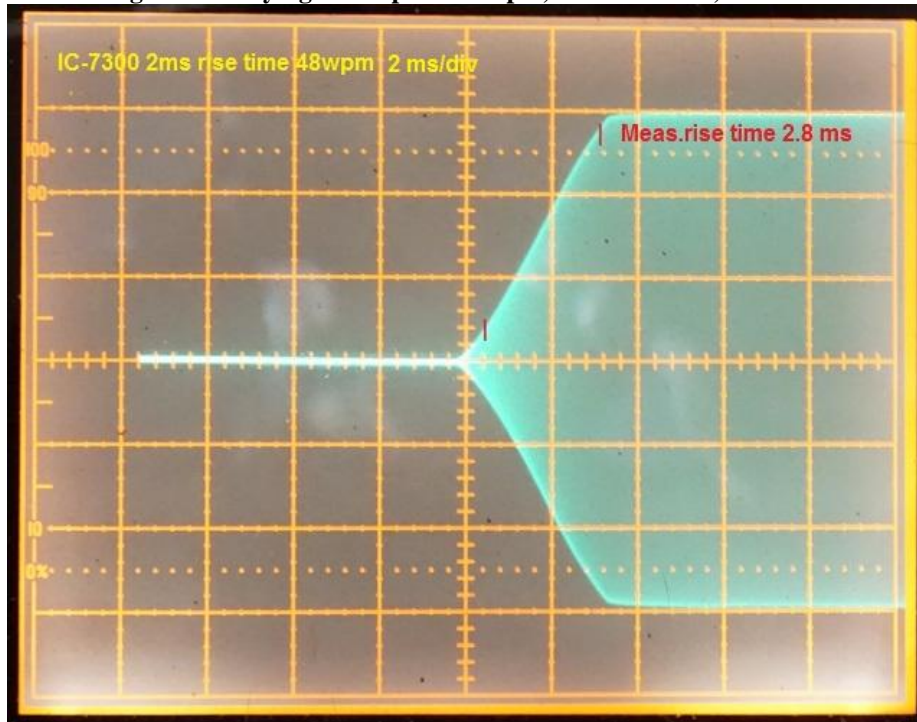

Figure 31: Keying envelope at 48 wpm, 4 ms rise time, 2 ms/div.

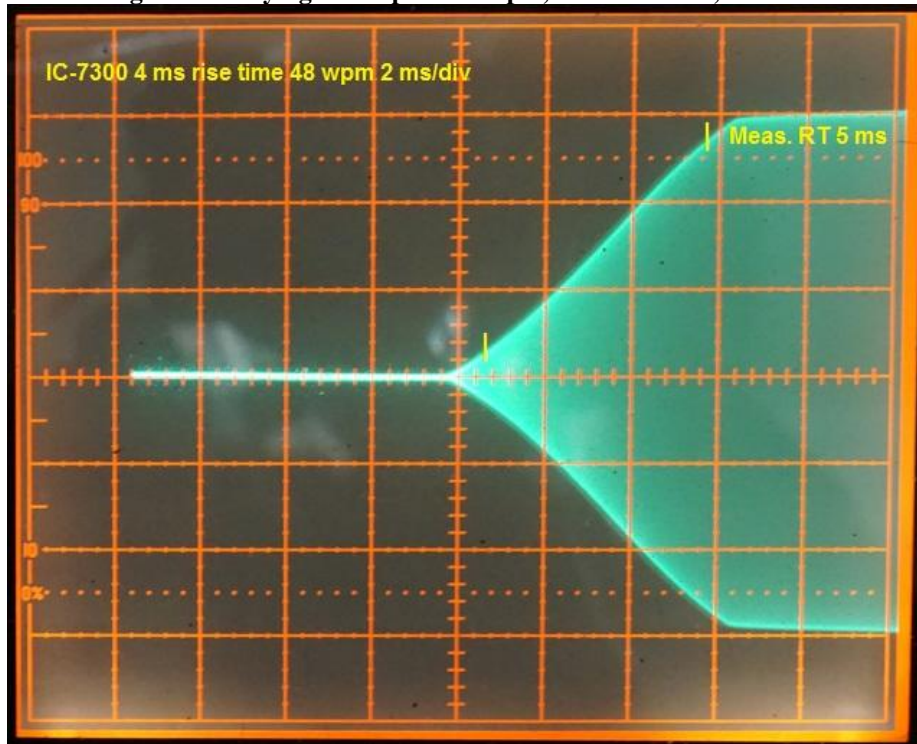

Figure 32: Keying envelope at 48 wpm, 6 ms rise time, 2 ms/div.

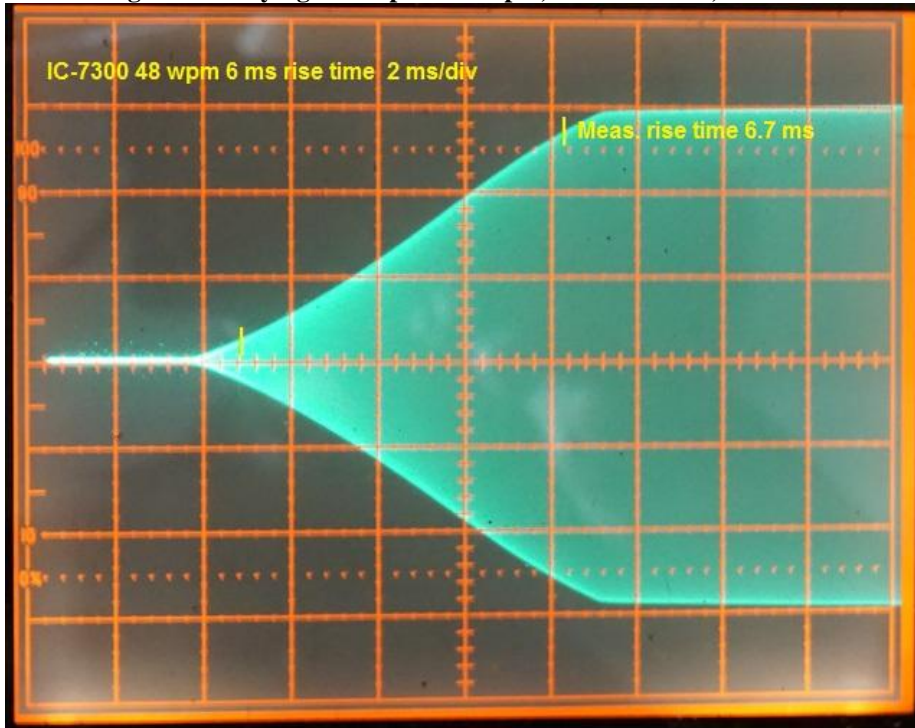
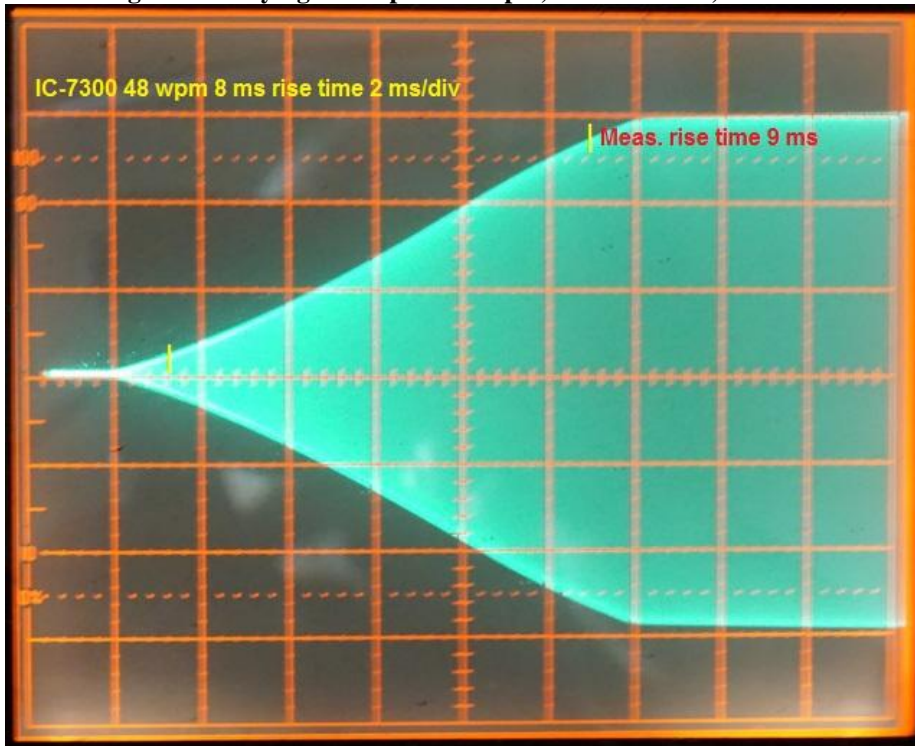

Figure 33: Keying envelope at 48 wpm, 8 ms rise time, 2 ms/div.



27b. CW QSK recovery test: This test was devised to measure the maximum speed at which the receiver can still be heard between code elements in QSK CW mode.

The IC-7300 is terminated in a 50 Ω 100W load via a directional coupler. A test signal is injected into the signal path via the directional coupler; a 20 dB attenuator at the coupled port protects the signal generator from reverse power. Test signal level is adjusted for S3...S5 at the receiver. As the coupler is rated at 25W max., RF PWR is set at 10W.

Test Conditions: 14.010 MHz, 500 Hz CW, preamp off, ATT off, NR off, NB off, F-BK on, rise time = 4 ms, RF PWR at 10W, KEY SPEED at 48 wpm (max.), CW Pitch default. Test signal at 14.0101 MHz. Sidetone = 600 Hz, received tone = 700 Hz.

Starting at minimum KEY SPEED, transmit a continuous string of dits and increase KEY SPEED until the received tone can just no longer be heard in the spaces between dits.

Test Result: In the current test, the received tone could still be heard distinctly at **22-23 wpm**.

28: ACC Pin 11 (MOD, analog baseband input) and USB MOD level for 100W output.) A 1 kHz test tone is injected into ACC Pin 11, and the input voltage required for 100W RF output is noted. Next, the tone generator program in the laptop computer is set up to apply a 1 kHz test tone to the USB MOD input.

Test Conditions: 14100 kHz USB, DATA OFF MOD = ACC, DATA-1 MOD = ACC, ACC MOD Level = 50% (default), TBW = WIDE/MID/NAR (default values), Bass/Treble = 0 dB (default), COMP off, test tone 1 kHz.

Adjust test tone level for \approx 100W output in USB and USB-D1 modes. The required input levels were **60 mV rms** for 100W output in USB, and **60 mV RMS** for 100W RF output (max. obtainable) in USB-D1.

Repeat test with DATA OFF MOD = USB, DATA-1 MOD = USB, USB MOD Level = 50% (default). 100W output was obtained with laptop tone generator level at 0 dB (nominal level) and USB MOD Level at 90%.

28a: Carrier and opposite-sideband suppression. A 1 kHz test tone is applied to ACC Pin 1, and then via the USB port. Carrier and opposite-sideband suppression are checked on the spectrum analyzer at 100W RF output for both cases.

Test Conditions: 14100 kHz USB, DATA OFF MOD = ACC/USB, DATA-1 MOD = ACC/USB, TBW = WIDE (default), test tone 1 kHz.

Adjust test tone level for 100W output. Read carrier amplitude at 14100 kHz, and opposite-sideband amplitude at 14099 kHz.

Test Results: For ACC and USB test-tone input, carrier and opposite sideband both < -80 dBc (at or below the spectrum analyzer's noise floor). See Figure 35.

Figure 34: Carrier & opposite-sideband suppression at 14.1 MHz.

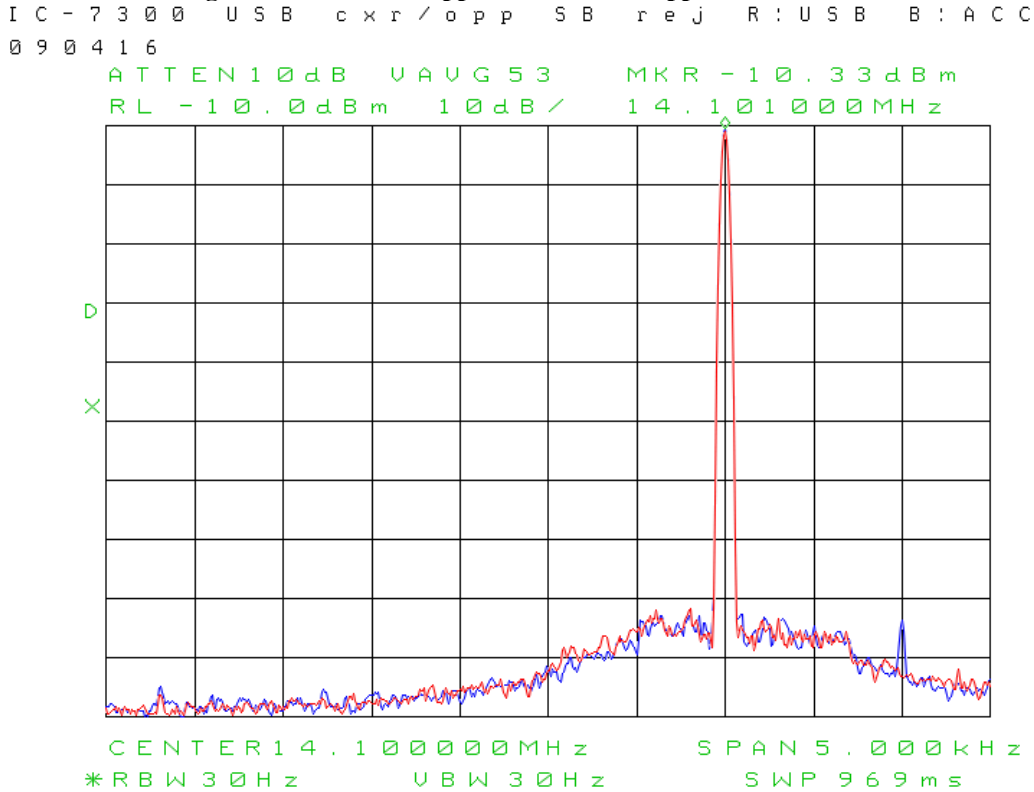

28b: SSB transmit audio-frequency response via USB port. In this test, a white-noise baseband is applied to the USB port from a tone-generator program running on a laptop computer. The spectrum analyzer is connected to the IC-7300 RF output via a 60 dB high-power attenuator.

Test Conditions: 14100 kHz USB, DATA OFF MOD = USB, USB MOD Level = 50% (default). Test signal: white noise. WIDE, MID and NAR TBW are at default values.

On computer, adjust USB Audio Codec device volume for 50% ALC reading. Using Marker on spectrum analyzer, measure frequency and relative amplitude at lower passband edge. Move marker “down” 6 dB and record frequency. Move marker “down” a further 14 dB and record frequency again. Repeat procedure for upper passband edge. The test data are shown in Table 22.

Table 22: Measured SSB TX lower and upper cutoff frequencies (via USB input).

TBW	Lower (Hz)		Upper (Hz)	
	-20 dB	-6 dB	-6 dB	-20 dB
1 kHz = 0 dB ref.				
WIDE	62	76	2967	3042
MID	146	242	2749	2842
NAR	358	442	2565	2629

29a: FM deviation: The IC-7300 output is connected to the RF IN/OUT port (75W max. input) of the communications test set. Voice and CTCSS peak deviation are checked.

Test Conditions: 29.6 & 52.525 MHz, FM, FIL1, RF PWR set at 25W.

Speak loudly into mic and read deviation. **Test Result:** Peak deviation = **4.3 kHz**.

Next, select CTCSS TONE = 100 Hz (1Z). Key IC-7300 and read tone frequency and deviation on test set. **Test Result:** Tone frequency 100.05 Hz, deviation 530 Hz.

29b: CTCSS decode sensitivity: The test set is configured as an RF generator. TSQL (CTCSS tone squelch) is enabled in the IC-7300 and the minimum RF input power and tone deviation at which the tone squelch opens are measured.

Test Conditions: 52.525 MHz, FM, FIL1, ATT off, CTCSS TSQL on, TONE 100 Hz (1Z). At test set, CTCSS tone deviation = 600 and 100 Hz.

Table 23: CTCSS Decode Sensitivity

Tone Dev. Hz	RF input level
700	-117
500	-115

30. Transmit latency: In this test, a function generator feeds repetitive bursts of one cycle of a 1 kHz tone to the DUT line audio input (ACC Pin 11) and also to Channel 1 of a dual-trace oscilloscope. Channel 2 is connected via a high-power 50 dB attenuator to the DUT ANT socket. The scope is triggered from the function generator's SYNC output. The time interval between the leading edge of the AF burst displayed on Channel 1 and that of the RF burst displayed on Channel 2 is recorded for WIDE, MID and NAR TBW settings.

Test Conditions: 14100 kHz USB, 100W, DATA OFF MOD = ACC, ACC MOD Level = 50% (default). Test signal: tone burst. WIDE, MID and NAR TBW are at default values. Scope sweep 1 ms/div.

Figure 35: Transmit latency, WIDE TBW. Latency 4.1 ms.

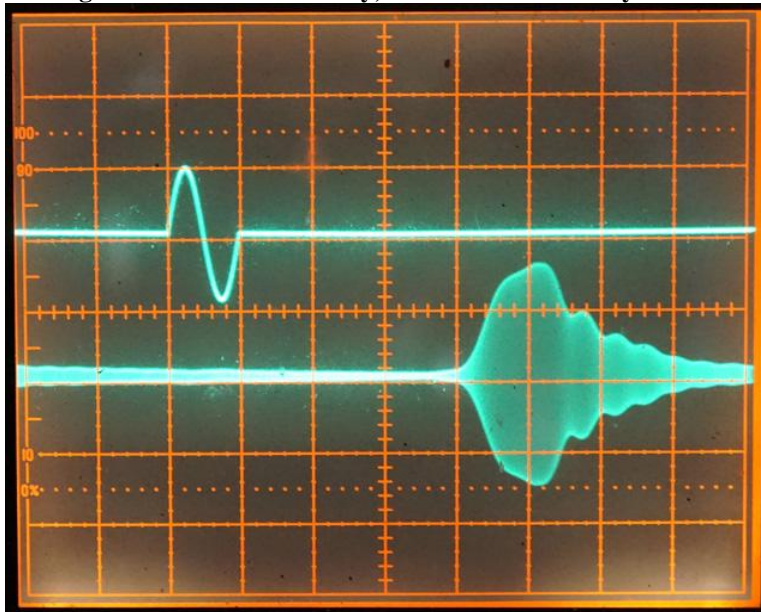

Figure 36: Transmit latency, MID TBW. Latency 4.2 ms.

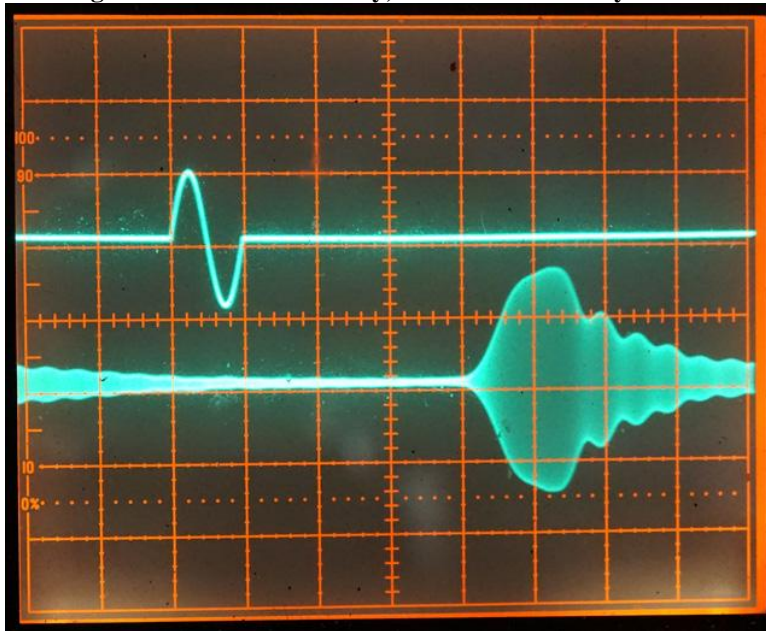
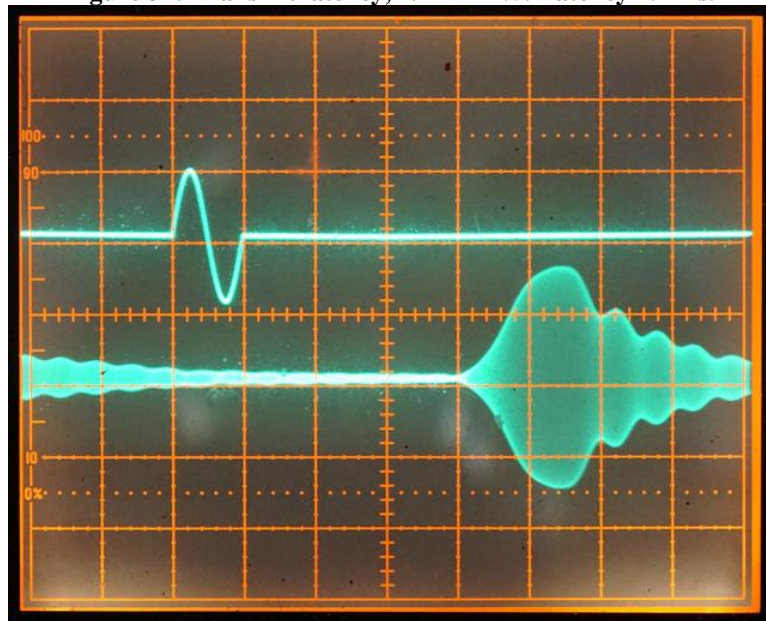

Figure 37: Transmit latency, NAR TBW. Latency 4.1 ms.



31. References:

1. HF Receiver Testing: Issues & Advances”:
<http://www.nsarc.ca/hf/rcvrtest.pdf>
2. “Noise Power Ratio (NPR) Testing of HF Receivers”:
http://www.ab4oj.com/test/docs/npr_test.pdf

Copyright © 2016 A. Farson VA7OJ/AB4OJ. All rights reserved. **April 14, 2016.**